

CALIFORNIA FOREST PRACTICE RULES 2024

*Title 14, California Code of Regulations
Chapters 4, 4.5 and 10*

with the
Z'BERG-NEJEDLY FOREST PRACTICE ACT;
Pertinent Excerpts from
PROTECTION OF FOREST, RANGE AND FORAGE LANDS -
PROHIBITED ACTIVITIES
and the
WILD AND SCENIC RIVERS ACT;
the
PROFESSIONAL FORESTERS LAW
and
REGISTRATION OF PROFESSIONAL FORESTERS RULES,
with information related to
MINING AND RECLAMATION REGULATIONS

Prepared for:
California Licensed Timber Operators
and California Registered Professional Foresters

Compiled by:
The California Department of Forestry and Fire Protection
Resource Management, Forest Practice Program
P.O. Box 944246
Sacramento, CA 94244-2460

CAL FIRE Website: www.fire.ca.gov

Gavin Newsom
Governor
State of California

Wade Crowfoot
Secretary for Natural Resources
Natural Resources Agency

Joe Tyler
Director
California Department of Forestry
and Fire Protection

2024 Version
First Printing

IMPORTANT INSTRUCTIONS

Sections 895 through 909.1 and 1020 through 1115.3 apply Statewide.

Coast District	Sections 911 thru 929.7
Northern District	Sections 931 thru 949.7
Southern District	Sections 951 thru 969.7

Search the Table of Contents for the topic of interest. For example, under Article 4 Harvesting Practices and Erosion Control, Felling Practices begins on Page 66. All Forest Districts are listed: 914.1, 934.1, 954.1, thus the rule that applies to the operation is the same for all three Districts.

Skim to find Rules that are unique to only one or two of the Districts. For example: 954.4 Site Preparation Addendum applies only in the Southern District. Both the Rules that apply in all Districts and those specific to any one District would apply in that particular District.

CHANGES AND COMMENTS

The underlined text of the Rules are those that were newly adopted, corrected, or amended since the previous edition of this rulebook (Note: internet and email links are also underlined but are not necessarily new since the last edition). Editorial comments are included in brackets and italicized (i.e., [*and Fire Protection*]). New editorial comments are included in brackets and underlined and italicized (i.e., [*and Fire Protection*]). Additional rule text pertaining to certain District-specific Rules may be bracketed (i.e., [and seasonal; **Southern**]).

FOREST PRACTICE RULES ONLINE

The CAL FIRE website is located at: www.fire.ca.gov. Digital versions of current and past Rules along with a link to the CAL FIRE Forest Practice website can be accessed at the Board of Forestry and Fire Protection website: <https://bof.fire.ca.gov/regulations/bills-statutes-rules-and-annual-california-forest-practice-rules/>

Digital versions of the Rules can be downloaded and searched by key terms with the ‘Ctrl+F’ function. These versions also have copy and paste text capabilities.

DISCLAIMER

This presentation of the Forest Practice Rules is intended to provide working Rules on California Timberlands for anyone with an interest in California Forest Practice. It is not intended to be authoritative. The official website for any California law or rule can be found at <https://leginfo.legislature.ca.gov/>. In addition, the Office of Administrative Law maintains a website for recent changes to the California Code of Regulations at <https://oal.ca.gov/>.

The official publication of the Rules is by Thompson Reuters Westlaw at <https://govt.westlaw.com/calregs>.

The California Department of Forestry and Fire Protection appreciates observations from readers citing errors in the Rules. Please send any comments and or potential corrections to: forestpracticehq@fire.ca.gov

CALIFORNIA FOREST PRACTICE RULES

TABLE OF CONTENTS

CALIFORNIA FOREST PRACTICE RULES 2024..... 2

Z'BERG-NEJEDLY FOREST PRACTICE ACT..... 304

**EXCERPTS FROM PROTECTION OF FOREST, RANGE AND FORAGE LANDS
PROHIBITED ACTIVITIES..... 364**

EXCERPTS FROM THE WILD AND SCENIC RIVERS ACT..... 366

PROFESSIONAL FORESTERS LAW..... 382

REGISTRATION OF PROFESSIONAL FORESTERS RULES..... 388

SURFACE MINING AND RECLAMATION ACT OF 1975 PRC..... 403

STATE MINING AND GEOLOGY BOARD RECLAMATION REGULATIONS..... 404

APPENDIX I: Board of Forestry Technical Rule Addendum No. 1..... 405

CALIFORNIA FOREST PRACTICE RULES 2024
Title 14, California Code of Regulations, Chapter 4

SUBCHAPTER 1 ABBREVIATION AND DEFINITIONS..... 2

Article 1 Abbreviations and Definitions 2

895 Abbreviations Applicable Throughout Chapter 2

895.1. Definitions 5

SUBCHAPTER 2 APPLICATION OF FOREST PRACTICE RULES 28

Article 1 Introduction 28

896 General..... 28

897 Implementation of Act Intent 28

Article 2 Preparation and Review of Timber Harvesting Plans..... 30

898 Feasibility Alternatives 30

898.1 Review of Plan by Director 30

898.2 Special Conditions Requiring Disapproval of Plans..... 31

Article 3 PRC 4555, Rule Review Procedures..... 32

900 Intent 32

901 Timber Harvesting Plan Decision Delay..... 32

902 Director's Notice to Board 32

902.1 Board Action 32

902.2 Notice Content 32

902.3 Notice Distribution 32

903.1 Content of Discussion and Prejudice of Appeal..... 33

903.2 Board Action 33

SUBCHAPTER 3 FOREST DISTRICT BOUNDARIES 33

Article 1 Districts..... 33

CALIFORNIA FOREST PRACTICE RULES

906 Forest Districts.....	33
907 Coast Forest District.....	33
908 Northern Forest District	34
909 Southern Forest District.....	34
909.1 High Use Subdistrict.....	34
SUBCHAPTERS 4, 5 & 6 FOREST DISTRICT RULES.....	34
Article 1 Introduction	34
911, 931, 951 Statement of Purpose.....	34
Article 2 Ratings and Standards	34
912.5 Procedure for Estimating Surface Soil Erosion Hazard Rating [Coast]	34
932.5, 952.5 Procedure for Estimating Surface Soil Erosion Hazard Rating [Northern, Southern].....	35
912.7, 932.7, 952.7 Resource Conservation Standards for Minimum Stocking	35
912.8 Progeny, Clonal, or Provenance Testing Stocking Standard Exemption [Coast only].....	37
912.9, 932.9, 952.9 Cumulative Impacts Assessment Checklist	38
BOARD OF FORESTRY TECHNICAL RULE ADDENDUM NO. 2 CUMULATIVE IMPACTS ASSESSMENT.....	39
Article 3 Silvicultural Methods	48
913, 933, 953 Silvicultural Objectives	48
913.1, 933.1, 953.1 Regeneration Methods Used in Evenaged Management	48
913.2, 933.2, 953.2 Regeneration Methods Used in Unevenaged Management.....	51
913.3, 933.3, 953.3 Intermediate Treatments	54
913.4, 933.4, 953.4 Special Prescriptions	55
913.5, 933.5, 953.5 Stocking Status.....	60
913.6, 933.6, 953.6 Alternative Prescriptions	60
913.7, 933.7 Exceptions [Coast, Northern].....	62
953.7 Riparian Vegetation [Southern].....	62
953.8 Exceptions [Southern].....	62
913.8 Special Harvesting Methods for Southern Subdistrict [Coast]	62
953.9 Successive Cutting [Southern only].....	63
913.10, 933.10, 953.10 Timberland Productivity, Sustained Forestry Planning, Addendum	63
913.11, 933.11, 953.11 Maximum Sustained Production of High Quality Timber Products	64
953.12 High Use Subdistrict.....	65
Article 4 Harvesting Practices and Erosion Control	65
914, 934, 954 Purposes	65
914.1, 934.1, 954.1 Felling Practices.....	65
914.2, 934.2, 954.2 Tractor Operations.....	66
914.3, 934.3, 954.3 Cable Yarding	66
954.4 Site Preparation Addendum [Southern only]	67
914.5, 934.5, 954.5 Servicing of Logging Equipment, Disposal of Refuse, Litter, Trash and Debris	67
914.6, 934.6, 954.6 Waterbreaks.....	67
914.7, 934.7, 954.7 Timber Operations, Winter Period.....	68
914.8, 934.8, 954.8 Tractor Road Watercourse Crossing	69
914.9, 934.9, 954.9 Alternatives to Standard Rules.....	69
Article 5 Site Preparation	70
915, 935, 955 Purposes	70
915.1, 935.1, 955.1 Use of Heavy Equipment for Site Preparation.....	70
915.2, 935.2, 955.2 Treatment of Vegetative Matter.....	70
915.3, 935.3, 955.3 Protection of Natural Resources.....	70
915.4, 935.4, 955.4 Site Preparation Addendum	71
Article 6 Water Course and Lake Protection.....	71

CALIFORNIA FOREST PRACTICE RULES

916, 936, 956 Intent of Watercourse and Lake Protection.....	71
916.1, 936.1, 956.1 In Lieu Practices	72
916.2, 936.2, 956.2 Protection of the Beneficial Uses of Water and Riparian Functions.....	72
916.3, 936.3, 956.3 General Limitations Near Watercourses, Lakes, Marshes, Meadows and Other Wet Areas.....	73
916.4, 936.4, 956.4 Watercourse and Lake Protection.....	73
916.5, 936.5, 956.5 Procedure for Determining Watercourse and Lake Protection Zone (WLPZ) Widths and Protective Measures	75
916.5, 936.5, 956.5 Procedures for Determining Watercourse and Lake Protection Zone Widths and Protective Measures	78
916.6, 936.6, 956.6 Alternative Watercourse and Lake Protection	78
916.7, 936.7, 956.7 Reduction of Soil Loss	79
916.8, 936.8, 956.8 Sensitive Watersheds	79
916.9, 936.9, 956.9 Protection and Restoration of the Beneficial Functions of the Riparian Zone in Watersheds with Listed Anadromous Salmonids.....	82
916.10, 936.10, 956.10 Domestic Water Supply Protection.....	105
916.11, 936.11, 956.11 Effectiveness and Implementation Monitoring.....	105
916.12, 936.12, 956.12 Section 303(d) Listed Watersheds	107
Article 7 Hazard Reduction.....	107
917, 937, 957 Hazard Reduction.....	107
917.2, 937.2, 957.2 Treatment of <i>[Logging]</i> Slash to Reduce Fire Hazard.....	108
917.2, 937.2, 957.2 Treatment of <i>[Logging]</i> Slash to Reduce Fire Hazard.....	108
917.2, 937.2, 957.2 Treatment of <i>[Logging]</i> Slash to Reduce Fire Hazard.....	109
917.3 Prescribed Broadcast Burning of Slash [Coast].....	109
937.3 Prescribed Broadcast Burning of Slash [Northern]	109
957.3 Prescribed Broadcast Burning of Slash [Southern].....	110
917.4 Treatment of Logging Slash in the Southern Subdistrict.....	110
957.4 Treatment of Logging Slash in the High Use Subdistrict.....	110
917.5, 937.5, 957.5 Burning of Piles and Concentrations of Slash.....	111
917.6, 937.6, 957.6 Notification of Burning	111
917.7, 937.7, 957.7 Protection of Residual Trees.....	111
917.9, 937.9, 957.9 Prevention Practices	111
BOARD OF FORESTRY TECHNICAL RULE ADDENDUM NO. 3.....	111
917.10, 937.10, 957.10 Locating and Reporting	112
Article 8 Fire Protection	112
918, 938, 958 Fire Protection [Coast, Northern, Southern]	112
918.1, 938.1, 958.1 Fire Suppression Resource Inventory.....	113
918.3, 938.3, 958.3 Roads to be Kept Passable	113
918.4, 938.4, 958.4 Smoking and Matches	113
918.5, 938.5, 958.5 Lunch and Warming Fires.....	113
918.6, 938.6, 958.6 Posting Procedures	113
918.7, 938.7, 958.7 Blasting and Welding	113
918.8, 938.8, 958.8 Inspection for Fire	113
918.8, 938.8, 958.8 Inspection for Fire	113
918.10, 938.10, 958.10 Cable Blocks.....	114
Article 9 Wildlife Protection Practices	114
919, 939, 959 Wildlife Practice	114
919.1, 939.1, 959.1 Snag Retention	114
919.2, 939.2, 959.2 General Protection of Nest Sites.....	114
919.3, 939.3, 959.3 Specific Requirements for Protection of Nest Sites.....	114
919.4, 939.4, 959.4 Non-listed Species	116
919.5, 939.5, 959.5 Alternatives	116
919.9, 939.9 Northern Spotted Owl.....	116

CALIFORNIA FOREST PRACTICE RULES

919.11 Marbled Murrelet Protective Measures [Coast]..... 118
919.12, 939.12, 959.12 Sensitive Species Classification..... 118
959.15 Protection of Wildlife Habitat [Southern]..... 119
919.16, 939.16, 959.16 Late Succession Forest Stands 119
Article 10 Violations of Rules Prior to Changes 120
920, 940, 960 Violations of Rules Prior to Changes 120
Article 11 Coastal Commission Special Treatment Areas 120
921, 961 Coastal Commission Special Treatment Areas [Coast, Southern, Special Treatment Area]... 120
921.1 Preliminary Field Work and Timber Harvesting Plans [Coast, Special Treatment Area]..... 120
961.1 Preliminary Field Work and Timber Harvesting Plans [Southern, Special Treatment Area]..... 121
921.2 Exemptions from Timber Harvesting Plan Requirements [Coast, Special Treatment Area]..... 121
961.2 Exemptions from Timber Harvesting Plan Requirements [Southern, Special Treatment Area]..... 122
921.3 Silvicultural Methods [Coast, Special Treatment Area] 122
961.3 Silvicultural Methods [Southern, Special Treatment Area] 124
921.4, 961.4 Stocking Requirements [Coast, Southern, STA]..... 125
921.5 Logging Practices [Coast, Special Treatment Area]..... 126
961.5 Logging Practices [Southern, Special Treatment Area]..... 126
921.6 Hazard Reduction [Coast, Special Treatment Area]..... 127
961.6 Hazard Reduction [C.C. Special Treatment Area]..... 127
921.7 Watercourse and Lake Protection [C.C. Special Treatment]..... 127
961.7 Watercourse and Lake Protection [Southern, Special Treatment Area]..... 127
921.8 Buffer Zones Within the Coastal Zone [Coastal Zone] 127
961.8 Buffer Zones Within the Coastal Zone [CZ, Southern] 128
921.9 Alternatives [Coast, CZ] 128
Article 12 [Article 11. Northern] Logging Roads, Landings, and Logging Road Watercourse Crossings 129
923 943, 963 Intent for Logging Roads, Landings, and Logging Road Watercourse Crossings..... 129
923.2 943.2, 963.2 Design and Location of Logging Roads and Landings 131
923.3 943.3, 963.3 Mapping and Identification of Logging Roads and Landings 132
923.4, 943.4, 963.4 Construction and Reconstruction of Logging Roads and Landings..... 133
923.5, 943.5, 963.5 Erosion Control for Logging Roads and Landings..... 134
923.6, 943.6, 963.6 Use of Logging Roads and Landings..... 137
923.7, 943.7, 963.7 Maintenance and Monitoring of Logging Roads and Landings 138
923.8, 943.8, 963.8 Abandonment and Deactivation of Logging Roads and Landings 140
923.9, 943.9, 963.9 Watercourse Crossings..... 140
923.9.1, 943.9.1, 963.9.1 Licensed Timber Operator Responsibility for Roads and Landings 143
BOARD OF FORESTRY TECHNICAL RULE ADDENDUM NO. 5: GUIDANCE ON HYDROLOGIC DISCONNECTION, ROAD DRAINAGE, MINIMIZATION OF DIVERSION POTENTIAL, AND HIGH RISK CROSSINGS (1st EDITION, revised 10/27/14) 143
Article 13 County Rules 153
924 County Rules Within the Southern Subdistrict of the Coast Forest District [Coast, SSD]..... 153
924.1 Plan Submittal and Notice of Intent [Coast, SSD]..... 153
924.2 Plan Filing [Coast, SSD]..... 154
924.3 Preharvest Inspection [Coast, SSD] 154
924.4 Notice of Filing [Coast, SSD] 154
924.5 Agency and Public Review [Coast, SSD] 154
COUNTY RULES, COAST DISTRICT..... 155
925 Santa Clara County Rules [Santa Clara County]..... 155
925.1 Winter Period [Santa Clara County]..... 155
925.2 Plan Submittal and Notice of Intent [Santa Clara County]..... 155
925.3 Plan Distribution [Santa Clara County]..... 155

CALIFORNIA FOREST PRACTICE RULES

925.4	Contents of the Plan [Santa Clara County].....	155
925.5	Tractor Yarding [Santa Clara County].....	156
925.6	Flagging [Santa Clara County]	156
925.7	Log Hauling [Santa Clara County].....	156
925.8	Public Road Buffer Zone [Santa Clara County].....	156
925.9	Public Road Protection [Santa Clara County].....	156
925.10	Hours of Work [Santa Clara County]	157
925.11	Performance Bonding [Santa Clara County].....	157
926	Santa Cruz County Rules [Santa Cruz County].....	157
926.1	Registered Professional Forester (RPF) Advice [Santa Cruz County].....	157
926.2	Field Review and Timber Operator Certification [Santa Cruz County].....	157
926.3	Plan Submittal and Notice of Intent [Santa Cruz County].....	158
926.4	Preharvest Inspection Report [Santa Cruz County]	159
926.5	Additional Information After Preharvest Inspection [Santa Cruz County]	159
926.6	Public Water Agency Representative [Santa Cruz County].....	160
926.7	Review Team Field Review [Santa Cruz County]	160
926.8	Fuelwood Operations [Santa Cruz County].....	160
926.10	Log Hauling [Santa Cruz County].....	161
926.11	Flagging of Property Lines [Santa Cruz County].....	161
926.12	Soil [Santa Cruz County].....	161
926.13	Performance Bonding [Santa Cruz County]	161
926.14	Biotic Resources [Santa Cruz County]	162
926.15	Road Construction [Santa Cruz County].....	162
926.16	Flagging [Santa Cruz County].....	162
926.17	Abandonment of Roads and Landings [Santa Cruz County].....	162
926.18	Winter Period [Santa Cruz County].....	162
926.19	Erosion Control Maintenance [Santa Cruz County].....	162
926.23	Contents of Plan [Santa Cruz County]	162
926.25	Special Harvesting Methods [Santa Cruz County].....	163
927	Marin County Rules [Marin County].....	163
927.1	Winter Period [Marin County]	163
927.2	Contents of Plan [Marin County].....	163
927.3	Tractor Yarding [Marin County]	164
927.4	Flagging [Marin County].....	164
927.5	Log Hauling [Marin County].....	164
927.6	Public Road Buffer Zone [Marin County]	165
927.7	Timber Harvesting Plans [Marin County].....	165
927.8	Exemptions from Timber Harvesting Plan Requirements [Marin County]	165
927.9	Silvicultural Methods and Intermediate Treatments [Marin County]	166
927.10	Stocking Requirements [Marin County]	166
927.11	Logging Practices [Marin County].....	166
927.12	Hazard Reduction [Marin County].....	167
927.13	Buffer Zones Within the CRC [Marin County]	167
927.14	Notice of Intent and Filing [Marin County]	167
927.15	Review Team Meetings [Marin County]	168
927.16	Registered Professional Forester (RPF) Advice [Marin County].....	168
927.17	Decisions on Winter Operations [Marin County].....	168
928	San Mateo County Rules [San Mateo County]	168
928.1	Definitions [San Mateo County].....	168
928.2	Contents of Plan [San Mateo County]	168
928.3	Flagging [San Mateo County].....	169
928.4	Performance Bonding [San Mateo County]	169
928.5	Hours of Work [San Mateo County].....	169
928.7	Cutting Practices [San Mateo County]	170
COUNTY RULES, NORTHERN DISTRICT.....		170
945	Lake County Rules [Lake County]	170
945.1	Statement of Purpose [Lake County].....	170

CALIFORNIA FOREST PRACTICE RULES

945.2 Definitions [Lake County] 170

945.3 Timber Harvest Prescriptions [Lake County] 170

945.4 Hours of Operation [Lake County]..... 171

945.5 Exempt and Emergency Notice Operations [Lake County] 171

C O U N T Y R U L E S , S O U T H E R N D I S T R I C T 171

965 Monterey County Rules [Monterey County] 171

965.1 Haul Routes [Monterey County] 171

965.2 Hauling to the Nearest Public Road [Monterey County] 172

965.3 Public Road Protection [Monterey County]..... 172

965.4 Log Hauling [Monterey County]..... 172

965.5 Winter Period [Monterey County]..... 172

965.6 Big Sur Coast [Monterey County] 172

965.7 Public Water Agency Representative [Monterey County]..... 173

965.8 Performance Bonding [Monterey County]..... 173

965.9 Erosion Control Maintenance [Monterey County]..... 173

965.10 THP Description [Monterey County] 173

Article 14 Archaeological and Historical Resource Protection 173

929, 949, 969 Statement of Purpose..... 173

929.1, 949.1, 969.1 Plan, and Emergency Notice Preparation 174

929.2, 949.2, 969.2 Protection Measures for Plans and Emergency Notices 3 Acres and Larger 177

929.3, 949.3, 969.3 Post Review Site Discovery 178

929.4, 949.4, 969.4 Archaeological Training Requirements..... 178

929.5, 949.5, 969.5 Site Recording 179

929.6, 949.6, 969.6 Protection of Sites During Timber Operations 179

929.7, 949.7, 969.7 Determination of Significance 179

SUBCHAPTER 7 ADMINISTRATION 180

Article 1 Timber Operator Licenses 180

1020 Board Authority Delegated..... 180

1022 License 180

1022.1 Limited Timber Operator License 180

1022.2 License for Site Preparation 180

1022.3 License for Erosion Control Maintenance 180

1022.4. Licensed Timber Operator Responsibilities..... 180

1022.5. Subcontractors to a Licensed Timber Operator 181

1023 Issuance of License 181

1023.1 Company, Corporation and Partnership Licenses 181

1024 Application Form and Content 181

1024.1 Timber Operator Education..... 181

1024.2 Qualifying Experience..... 181

1024.3 Application Processing 182

1024.4 Returned Checks 182

1024.5 Insurance Maintenance..... 182

1024.6. Employee with Wages as Sole Compensation 182

1025 Fees for Licenses 182

1026 License Renewal 183

1027 License Denial 183

1027.1 Basis of Denial..... 183

1027.2 Partnership and Corporation Denials 183

1027.3 Multiple Licenses..... 183

1029 License Availability 183

1030 Change of Address..... 183

Article 2 Timber Harvesting Plan..... 184

1032 Timber Harvesting Plan Filing Locations 184

CALIFORNIA FOREST PRACTICE RULES

1032.7 Plan Submittal and Notice of Intent..... 184
1032.8 Notice of Intent-Distribution by Director..... 185
1032.9 Request for Notification of Timber Harvesting Plan Submission 186
1032.10 Request for Information on Domestic Water Supplies 186
1033 Filing Date..... 186
1034 Contents of Plan..... 186
1034.2 Professional Judgment 189
1035 Plan Submitter Responsibility..... 189
1035.1 Registered Professional Forester Responsibility..... 190
1035.2 Interaction Between RPF and LTO 190
1035.3 Licensed Timber Operator Responsibilities..... 191
1035.4 Notification of Commencement of Operations..... 191
1036 Deviations..... 192
1036.1 Murrelet Protection before Notice of Completion 192
1037 THP Preharvest Inspection-Filing Return 192
1037.1 Notice of Filing..... 192
1037.3 Agency and Public Review..... 192
1037.4 Director's Determination 193
1037.5 Review Teams to be Established 193
1037.6 Nonconformance of Plan..... 195
1037.7 Conformance of Plan..... 195
1037.8 Notice of Conformance..... 196
1037.9 Public Inspection 196
1037.10 Review Period Waiver..... 196
1037.11 Notice of Waiver 196
1038 Exemption 196

BOARD OF FORESTRY TECHNICAL RULE ADDENDUM NO. 4: ILLUSTRATION OF REMOVAL OF LADDER FUELS AND HORIZONTAL CONTINUITY OF FUELS 199

1038.1 Additional Exceptions or Requirements..... 203
Table 1: Additional Exceptions or Requirements..... 203
1038.2 Mapping Standards for Notices of Exceptions 205
Table 1: Mapping Requirements 205
1038.3 Forest Fire Prevention Exemption..... 206
1038.4 Mapping Standards for the Forest Fire Prevention Exemption..... 209
1038.9 Agency Exemptions 210
1039 Amendment..... 210
1039.1 Effective Period of the Plan 210
1040 Report Minor Deviations 210
1041 Limitations 211
1042 Change of Ownership..... 211
1043 Cancellation of Plans..... 211
1045 Director Delegation 211
1050 Erosion Control Maintenance 211
1051 Modified THP 212
1051.1 Contents of Modified THP..... 213
1051.2 Review of Modified THP..... 213
1051.3. Modified THP for Fuel Hazard Reduction..... 213
1051.4. Modified THP for Fuel Hazard Reduction Conditions and Mitigations 214
1051.5 Contents of Modified THP for Fuel Hazard Reduction..... 215
1051.6. Review of Modified THP for Project Area Fuel Hazard Reduction 216
1051.7. Evaluation of Regulations 216
1052.1 Emergency Conditions 218
1052.2 Emergency Substantiated by RPF 218
1052.3 Emergency Notice For Insect Damaged Timberlands..... 219
1052.5. Emergency Notice for Outbreaks of Sudden Oak Death Disease..... 221

CALIFORNIA FOREST PRACTICE RULES

Article 3 Timber Harvesting Plan Appeal Procedures..... 223

- 1053 Purpose of Regulations..... 223
- 1054 Return of Plan by Director 223
 - 1054.1 Right to Request Public Hearing..... 223
 - 1054.2 Form of Request for Hearing 223
 - 1054.3 Filing of Request for Hearing..... 224
 - 1054.4 Public Hearing 224
 - 1054.5 Notice of Hearing..... 224
 - 1054.6 Hearing Record..... 224
 - 1054.7 Hearing Procedures..... 224
 - 1054.8 Order of the Board 225
- 1055 County Appeals Procedures 225
 - 1055.1 Hearing on County Appeal..... 225
 - 1055.2 County Appeal Hearing Procedures-Scheduling 226
 - 1055.3 County Appeal Hearing Procedures-Notice..... 226
 - 1055.4 County Appeal Hearing Procedures-Record 226
 - 1055.5 County Appeal Hearing Procedures-Sequence..... 226
 - 1055.6 County Appeal Hearing Procedure-Order..... 226
- 1056 Head of Agency Appeals Procedure..... 227
 - 1056.1 Hearing on Head of Agency Appeal..... 227
 - 1056.2 Head of Agency Appeal Hearing Procedures-Scheduling..... 228
 - 1056.3 Head of Agency Appeal Procedures-Notice..... 228
 - 1056.4 Head of Agency Appeal Hearing Procedures-Record 228
 - 1056.5 Head of Agency Appeal Hearing Procedures-Sequence..... 228
 - 1056.6 Head of Agency Appeal Hearing Procedures-Order..... 229

Article 3.2 Administrative Penalty Hearing Procedures..... 229

- 1057 Purpose of Regulations..... 229
 - 1057.1 Filing of Petition and Notice of Defense/Request for Hearing 229
 - 1057.2 Failure to Request Hearing..... 229
 - 1057.3 Hearing Procedures..... 229
 - 1057.4 Administrative Record..... 230
 - 1057.5 Petition and Notice of Defense/Request for Hearing Form..... 231
- 1058 Hearing Procedures-Notice..... 232
 - 1058.1 Hearing Procedures-Recording and Transcription..... 232
 - 1058.2 Hearing Procedures-Use of Board Hearing Procedure and Sequence..... 232
 - 1058.3 Hearing Procedures-Determination..... 232
 - 1058.4 Review of Proposed Decision and Findings of Fact..... 233
 - 1058.5 Determination 233
- 1059 Infractions 233

Article 4 Timber Site Classification 234

- 1060 Site Classification 234

Article 5 Standardized Stocking Sampling Procedures 235

- 1070 Stocking Sampling..... 235
- 1071 Minimum Stocking Standards..... 235
- 1072 Stocking Sampling Procedures..... 235
 - 1072.1 Number of Plots Required 235
 - 1072.2 Plot Layout..... 236
 - 1072.3 Equipment..... 236
 - 1072.4 Exclusions..... 236
 - 1072.5 Basal Area Stocking Sampling Procedure..... 236
 - 1072.6 Point Count Stocking Sampling Procedure..... 236
 - 1072.7 Combination Stocking Sampling Procedure 237
- 1073 Unacceptable Results..... 237
- 1074 Waiver Request..... 238
 - 1074.1 Waiver Approval..... 238

CALIFORNIA FOREST PRACTICE RULES

1075 Report of Stocking..... 239

Article 6 Stocking Standards for Substantially Damaged Timberlands..... 239

 1080 Substantially Damaged Timberlands..... 239

 1080.1 Stocking Requirements for Substantially Damaged Timberlands..... 239

 1080.2 Timber Harvesting Plans for Substantially Damaged Timberlands..... 239

 1080.3 Stocking Distribution 240

 1080.4 Stocking Reports for Substantially Damaged Timberlands 240

 1080.5 Time Period to Meet Stocking Requirements 240

Article 6.5 Nonindustrial Timber Management Plan Administration..... 240

 1090 Rule Application..... 240

 1090.01. Definitions. 240

 1090.1 Timber Management Plan and Notice of Timber Operations Filing Locations 240

 1090.2 NTMP Submittal and Notice of Preparation 241

 1090.3 Notice of Preparation-Distribution by Director..... 241

 1090.4 Request for Notification of NTMP or Notice of Timber Operations Submission 241

 1090.5 Contents of NTMP..... 242

 1090.6 Notice of Timber Operations 244

 1090.7 Notice of Timber Operations Content 244

 1090.8 NTMP Professional Judgment 245

 1090.9 Plan Submitter Responsibility 246

 1090.10 Registered Professional Forester Responsibility..... 246

 1090.11 Interaction Between RPF and LTO on Notice of Timber Operations 246

 1090.12 Licensed Timber Operator Responsibilities..... 247

 1090.13 Notification of Commencement of Operations..... 247

 1090.14 NTMP Deviations 247

 1090.16 Notice NTMP of Filing 248

 1090.17 Agency and Public Review for the NTMP..... 248

 1090.18 Director's Determination 249

 1090.19 Review Teams to be Established to Review Timber Management Plan 249

 1090.20 Nonconformance of NTMP..... 249

 1090.21 Conformance of NTMP..... 249

 1090.22 Notice of Conformance of the NTMP 249

 1090.23 Public Inspection 250

 1090.24 Amendment..... 250

 1090.25 Report Minor Deviations 250

 1090.26 Change of Ownership..... 250

 1090.27 Cancellation of Plans 250

 1090.28 State Retoration Projects..... 251

Article 6.75 Sustained Yield Plan..... 251

 1091.1 Sustained Yield Plan..... 251

 1091.2 Relation to THPs 251

 1091.3 Definitions 251

 1091.4 Sustained Yield Plan Contents 251

 1091.4.5 Sustained Timber Production Assessment 252

 1091.5 Fish and Wildlife Assessment 253

 1091.6 Watershed Assessment and Planning 253

 1091.7 Limitation on Information Requirements 254

 1091.8 Compliance and Effectiveness Evaluation..... 254

 1091.9 SYP Effective Period 254

 1091.10 Review of Sustained Yield Plan (SYP)..... 254

 1091.11 Appeals 255

 1091.12 Emergency Departures from SYP..... 255

 1091.13 Amendments 255

 1091.14 Timber Harvest Plans Submitted Within a SYP Management Unit..... 255

 1091.15 Requests for Renewal of Approved Sustained Yield Plans..... 256

CALIFORNIA FOREST PRACTICE RULES

Article 6.8 Program EIR and THP 256

- 1092 Rule Application 256
- 1092.01 PTEIR and PTHP 257
- 1092.02 Director's Guidance for Review of PTEIR 257
- 1092.03 Program Timber Harvesting Plan Filing Locations 257
- 1092.04 Program Timber Harvesting Plan (PTHP) Submittal 257
- 1092.06 Request for Notification of PTHP Submission 258
- 1092.07 Request for Information on Domestic Water Supplies 259
- 1092.08 Filing Date 259
- 1092.09 PTHP Contents 259
- 1092.10 PTHP Professional Judgment 261
- 1092.11 PTHP Submitter Responsibility 261
- 1092.12 Registered Professional Forester Responsibility 262
- 1092.13 Interaction Between RPF and LTO on the PTHP 263
- 1092.14 Licensed Timber Operator Responsibilities 263
- 1092.15 Notification of Commencement of Operations 264
- 1092.16 PTHP Review Inspection-Filing Return 264
- 1092.17 Notice of PTHP Filing 264
- 1092.18 Agency and public Review for the PTHP 264
- 1092.19 Time Periods for Review 265
- 1092.20 Director's guidance for review of PTHP 265
- 1092.21 Special Conditions Requiring Disapproval of a PTHP 266
- 1092.22 Nonconformance of PTHP 266
- 1092.23 Conformance of PTHP 266
- 1092.24 Notice of Conformance of the PTHP 266
- 1092.25 Public Inspection 266
- 1092.26 Amendment 266
- 1092.27 Report Minor Deviations 267
- 1092.28 Effective Period of the PTHP and PTEIR 267
- 1092.29 Change of Ownership 268
- 1092.30 Cancellation of PTHP 268
- 1092.31 Appeals 268
- 1092.32 Interim Measures for Maximum Sustained Production 268

Article 6.9. Road Management Plan 268

- 1093 Road Management Plan 268
- 1093.1 Guidelines For an Orderly Evaluation of Activities Proposed by an RMP 268
- 1093.2 Contents of Road Management Plan 269
- 1093.3 Limitations on Information Requirements 271
- 1093.4 RMP Effective Period 271
- 1093.6 Notice of Filing 271

Article 6.95. Working Forest Management Plan 271

- 1094 Rule Application 271
- 1094.1 Working Forest Management Plan and Working Forest Harvest Notice Filing Locations 272
- 1094.2 Definitions 272
- 1094.3 WFMP Submittal and Notice of Preparation to Harvest Timber 273
- 1094.6 Notice of Preparation to Harvest Timber-Distribution by Director 273
- 1094.5 Request for Notification of WFMP or Working Forest Harvest Notice Submission 274
- 1094.6 Contents of WFMP 274
- 1094.7 Working Forest Harvest Notice 278
- 1094.8 Working Forest Harvest Notice Content 278
- 1094.9 WFMP Professional Judgment 281
- 1094.10 Plan Submitter(s) Responsibility 281
- 1094.11 Registered Professional Forester Responsibility 281
- 1094.12 Interaction Between RPF and LTO on Working Forest Harvest Notice 282
- 1094.13 Licensed Timber Operator Responsibilities 282

CALIFORNIA FOREST PRACTICE RULES

1094.14	Notification of Commencement of Operations.....	282
1094.15	Notice of WFMP Filing.....	282
1094.16	Agency and Public Review for the WFMP.....	283
1094.17	Director's Determination.....	284
1094.18	Review Teams to be Established to Review WFMP.....	285
1094.19	Nonconformance of WFMP.....	285
1094.20	Conformance of WFMP.....	285
1094.21	Notice of Conformance of the WFMP.....	285
1094.22	Public Inspection.....	285
1094.23	Substantial Deviations.....	285
1094.24	Report of Minor Deviations.....	286
1094.25	Report of Completion of Work Described in WFMP; Partial Completion Report.....	287
1094.26	Inspection of Completed Work.....	287
1094.27	Stocking Report and Minimum Stocking Standards.....	287
1094.28	Inspection of Stocking.....	287
1094.29	Five (5) Year Review of WFMP.....	287
1094.30	Change of Timberland Owner(s).....	288
1094.31	Cancellation of Plans.....	289
1094.32	Transition or Expansion of Plans.....	289
1094.33	Safe Harbor Agreement.....	289
1094.34	State Restoration Projects.....	290
1094.35	Southern Subdistrict.....	290
Article 7	Conversion of Timberland.....	290
1100	Definitions.....	290
1101	Purpose.....	291
1102	Authority Delegated to Director.....	291
1103	Conversion of Timberland.....	291
1103.1	Prohibited Activity.....	291
1103.2	Public Records.....	291
1104	Operations Requiring Conversion Permit.....	292
1104.1	Conversion Exemptions.....	292
1104.2	Exemption for Conversion of Non-TPZ Land for Subdivision Development.....	298
1104.3	Timberland Conversion Permit Fees.....	298
1105	Application.....	299
1105.1	Application Fees.....	299
1105.2	Director's Determination.....	299
1105.3	Conversion Plan.....	299
1105.4	Additional Proof.....	299
1106	Conversion Permit Issuance.....	299
1106.1	Contents of Conversion Permit.....	300
1106.2	Timber Harvesting Plan Processing.....	300
1106.3	Recordation, Renewal, Transferability.....	300
1106.4	Conversion Permit Denial.....	300
1106.5	Denial, Suspension, Revocation.....	300
1107	Cancellation by Permittee.....	300
1108	Coastal Zone Conversion.....	301
1109	Immediate Rezoning.....	301
1109.1	City or County Tentative Approval.....	301
1109.2	Public Interest.....	301
1109.3	No Substantial and Unmitigated Adverse Effect Upon Other Timberland Production Zones Within One Mile (1.609 km).....	302
1109.4	Suitability of Soils, Slopes, and Watersheds.....	302
1109.5	No Other Reasonable or Comparable Timber Growing Use.....	302
1109.6	Supplemental Data and Opinions.....	302
1110	Conversion Permit Within TPZ Not Required.....	302
CHAPTER 4.5	Hearings [in Rule Counties].....	302

CALIFORNIA FOREST PRACTICE RULES

1115 Time for Request	302
1115.1 Scheduling	303
1115.2 Notification	303
1115.3 Conduct of Hearing	303
Z'Berg-Nejedly Forest Practice Act Division 4, Chapter 8, Public Resources Code	304
Article 1 General Provisions	304
4511 Title of act	304
4512. Forest resources and timberlands; utilization, restoration, and protection ; legislative findings and declarations.	304
4512.5. Sequestration of carbon dioxide; legislative findings and declarations.	304
4513. Timberlands; creation and maintenance of system of regulation and use; legislative intent	304
4514. Chapter, ruling, requirement, or policy of board as not limiting specified powers and rights.	305
4514.3. Exemption from waste discharge requirements; conditions.	305
4514.5. Writ of mandate.	305
4516. Agency rules and regulations.	305
4516.5. County recommendation of rules and regulations; timber operations; board rules and regulations; limitation on enforcement and validity of local ordinances, rules and regulations; applicability of section.	305
4516.6. Delay between approval and commencement of timber operations; waiver; appeal of approval.	306
4516.8. Recommendations by counties for adoption of additional rules and regulations.	307
4517. Severability.	307
Article 2. Definitions.	307
4521. Definitions.	307
4521.3. Board.	307
4523. District.	307
4524. License.	307
4525. Person.	308
4525.3. Resource conservation standards.	308
4525.5. Rules.	308
4525.7. Slash.	308
4526. Timberland.	308
4526.5. Timber operator.	308
4527. Timber operations; commercial purposes; criteria.	308
4527.5. Timber owner.	309
4528. Additional definitions.	309
4528.5. Applicability to employees.	309
4529. Penalties and remedies, concurrent and alternative.	309
4529.5. Forms of service.	309
Article 3. Districts and Committees.	309
4531. Establishment of districts.	309
Article 4. Rules and Regulations.	310
4551. Adoption of district forest practice rules and regulations.	310
4551.3. Sustained yield plans; effective period; monitoring process; public hearings; notice.	310
4551.5. Application, development.	311
4551.7. Site preparation.	311
4551.9. Regulations with respect to requiring a map or maps with timber harvesting plans; conditions and contents of maps; impact on smaller landowners.	311
4552. Basis of rules and regulations; standards for preparing harvesting plans.	311
4553. Review and revision of rules and regulations.	311
4554. Public hearing for adoption or revision of rules, etc; notice.	311
4554.5 Rules and regulations; effective dates.	312
4555. Withholding decisions; emergency regulations.	312

CALIFORNIA FOREST PRACTICE RULES

4556. Forest management task force..... 312

Article 5. Resource Conservation Standards..... 312

4561. Stocking standards..... 312

4561.1. Application of standards; board standards..... 313

4561.2. Alternative stocking standards..... 313

4561.5. Permanent stocking standards; adoption and amendment..... 313

4561.7. Site designated for testing purposes; exemption from stocking requirement; testing location..... 313

4562. Fire protection zone rules..... 313

4562.5. Control of soil erosion; report; regulations..... 314

4562.7. Protection of streams; rules..... 314

4562.9. Maintenance of installed drainage facilities and soil stabilization treatments; regulations..... 314

Article 6. Licenses..... 314

4570. Real Person in Interest..... 314

4571. Necessity of license..... 314

4572. Form and content of application; procedures; filing fee..... 315

4573. Reasons for denial..... 315

4574. Term of licenses; denial of renewal..... 315

4575. Effect of future legislation; transferability..... 316

4576. Suspension or revocation..... 316

4576.1 Period of suspension, revocation, or denial; ownership or other interest in timber operations..... 316

4577. Delegation of authority..... 316

4578. Forest practices; licenses; exemptions..... 316

Article 7. Timber Harvesting..... 316

4581. Necessity of timber harvesting plan..... 316

4582. Contents of timber harvesting plan..... 316

4582.3. Notice of intent to harvest timber; adoption of regulations..... 317

4582.4. Notice of filing to person requesting in writing..... 317

4582.5. Applicability of plan to specific property..... 317

4582.6. Availability of timber harvesting plan for public inspection; transmittal of copies to agencies; specific comments or recommendations; hearings on plans..... 317

4582.7. Review of plan; public comments; time; hearing; determination by board and director..... 318

4582.71. Findings by a regional water quality control board under which a timber harvesting plan may not be approved; discharge into a impaired watercourse; delegation of board authority; notice of finding; role of director..... 319

4582.75. Rules and provisions of this chapter as criteria for reviewing timber timber harvesting plans..... 319

4582.8. Transmittal of plans to Board of Equalization..... 319

4582.9. Appeal of approved plan; conditions of filing; suspension of timber operations; hearing..... 319

4583. Standards and rules; conformance of plan; changes or modifications; exceptions..... 320

4583.2. Report of deviations in plan which threaten attainment of standards or regulations..... 320

4583.5. Disciplinary action for material misstatement in filing of plan or report..... 320

4584. Exempt Activities..... 321

4584.1. Exempt Conditions..... 327

4584.2. Exempt Forest Fire Prevention..... 329

4584.5. Yield Taxes..... 330

4585. Report of completion of work described in plan; partial completion report..... 330

4586. Inspection of completed work..... 330

4587. Stocking report; filing date; sampling procedures; waiver..... 330

4588. Inspection of stocking; report of satisfactory completion..... 331

4589. Exemption and Emergency Monitoring..... 331

4590. Term of plan and stocking work; extensions..... 331

4591. Amendments to plan; term of amendment..... 332

4591.1. Permissible deviations..... 332

CALIFORNIA FOREST PRACTICE RULES

4592. Emergency notice; contents..... 332

4592.5 Timber harvesting plans; guidance and assistance..... 332

Article 7.5. Nonindustrial Timber Management Plan..... 333

4593. Legislative findings and declaration..... 334

4593.2. Definitions..... 334

4593.3. Filing of plan; preparation; contents..... 334

4593.4. Notice of receipt of plan..... 335

4593.5. Requests for notice..... 335

4593.6. Public inspection of plan; copies for interdisciplinary review; comments from public agencies..... 335

4593.7. Review of plans; non-conforming plans; denial of plans; appeals..... 335

4593.8. Amendment of approved plan..... 336

4593.9. Non-substantial deviations from plan..... 336

4593.10. Change of land ownership; duty of transferring landowner to notify acquiring landowner of existence of plan; notice provided by department; notice of assumption of plan; violation..... 336

4593.11. Cancellation of plan by tree farmer..... 336

4594. Notice of harvest within area covered by a plan; contents of notice..... 336

4594.2. Deviations from plan; notice by professional forester..... 337

4594.4. Material misstatement by professional forester; disciplinary action..... 337

4594.6. Commencement of timber operations..... 337

4594.7. Cancellation of plan by department..... 337

Article 7.7. Working Forest Management Plan..... 338

4597. Findings and declarations..... 338

4597.1. Definitions..... 338

4597.2. Working forest management plans; contents..... 339

4597.3. Regulations regarding notice of receipt of proposed working forest management plan..... 341

4597.4. Required notices; Internet Web site and in writing request..... 341

4597.5. Public inspection of propose plan; transmission to other state and regional agencies; invitation of public comments..... 341

4597.6. Time for public comment; requirements for approval; denial; hearing revised plans..... 341

4597.7. Amendment to plan; proposal; public comment and review..... 342

4597.8. Actions without submission of amendment; subsequent report; regulations..... 343

4597.9. Change of land ownership; duty of transferring landowner to notify acquiring landowner of existence of plan; notice provided by department; notice of intent to assume plan; violation..... 343

4597.10. Cancellation of plan; notice..... 343

4597.11. Working forest harvest notice; requirements; duration..... 343

4597.12. Interdisciplinary review team; field inspections; five-year reviews; public notice; disclosure of proprietary information not authorized..... 344

4597.13. Registered professional forester; reports of deviation from plan..... 345

4597.14. Registered professional forester; material misstatements in notice..... 345

4597.15. Written declaration of registered professional forester; sufficiency of working forest harvest notice; commencement of operations..... 345

4597.16. Failure to meet objectives of uneven aged management and sustained yield or other persistent violations; cancellation, appeal..... 345

4597.17. Landowner with less than 2,500 acres; expansion; amendment of plan..... 345

4597.18. Safe harbor agreement; costs..... 346

4597.19. State restoration grand funding not precluded..... 346

4597.21. Applicability of county rules or court decision..... 346

4597.22. Application of article..... 346

Article 7.8. Program Timberland Environmental Impact Report for Carbon Sequestration and Fuel Reduction Program..... 346

4598. Legislative findings and declarations..... 346

4598.1. Purpose of article..... 347

4598.2. Authority of department to enter agreements and make grants..... 347

4598.3. Definitions..... 347

CALIFORNIA FOREST PRACTICE RULES

4598.4. Authority of director to enter agreements and make grants. 347

4598.5. Agreements and grants on behalf of eligible landowners..... 347

4598.6. Eligibility for participation in agreement or grant; conditions. 348

4598.7. Payments or grants for work subject to assistance provided by federal law. 348

4598.8. Landowner eligibility requirements..... 348

4598.9. Procedure for promulgating regulations, guidelines, or publications..... 349

Article 8. Penalties and Enforcement. 349

4601. Penalty..... 349

4601.1. Violation of Chapter; civil penalty; judicial imposition or administrative imposition..... 349

4601.2. Administrative civil penalty..... 350

4601.3. Judicial review..... 350

4601.4. Violation of rule or regulation not resulting in environmental damage; infraction..... 351

4601.5. Fines for infractions; correctable violations..... 351

4602.5. Temporary suspension of operations pending judicial remedies; procedures; violations; penalties..... 351

4602.6. Temporary suspension of operations pending judicial remedies; lack of reasonable cause; claim against public entities; amount of damages. 352

4603. Action to enforce compliance..... 352

4604. Inspection of timber operation; periodic inspections; operative date..... 352

4605. Action to enjoin violations; temporary restraining order..... 353

4606. Form of injunctive relief; bond. 353

4607. Correction of violations; expenses..... 354

4608. Notice of corrective action; form; contents; service; lien..... 354

4609. Action upon noncompliance with notice; public hearing by board; order..... 354

4610. Expenses of corrective action; debt of person responsible; collection. 355

4611. Entry upon land to take corrective action; civil liability..... 355

Article 9. Conversion..... 355

4621. Application for conversion; procedure, form, fees and content to be prescribed..... 355

4621.2. Proposed alternate use; information; findings required for approval..... 355

4622. Conditions for approval of application..... 356

4623. Affidavit of intent to convert land; additional proof of intent..... 356

4624. Denial of conversion permit; reasons..... 356

4624.5. Hearing on denial of permit..... 356

4625. Approval of application for permit..... 356

4626. Revocation of permit..... 356

4627. Delegation of authority..... 356

4628. Exemptions from regulations; right-of-way construction or maintenance; subdivision development..... 356

Article 9.5. Timber Regulation and Forest Restoration Fund..... 357

4629. Legislative findings and declarations..... 357

4629.1. Additional legislative findings regarding the state’s forest practice regulatory program. 357

4629.2. Legislative intent; purpose of article..... 357

4629.3. Timber Regulation and Forest Restoration Fund; creation deposit of funds; definitions. 358

4629.4. Adoption of regulation regarding lumber products and engineered wood products subject to lumber products assessment; annual update; adoption of additional regulations or emergency regulations..... 358

4629.5. Lumber products assessment; imposition, administration, and collection; regulations; regulations; registration by persons required to pay assessment..... 359

4629.6. Expenditure of appropriated moneys..... 360

4629.7. Grants; priority of activities to be funded..... 361

4629.8. Appropriation of funds; priorities. 361

4629.9. Annual submission of report on forest and timberland regulation to Joint Legislative Budget Committee..... 362

4629.10. Submission of report including review of report on forest and timberland regulation to Joint Legislative Budget Committee and to the relevant legislative policy committees..... 362

CALIFORNIA FOREST PRACTICE RULES

4629.11. Accounting of revenues on accrued basis; authorization to borrow against anticipated revenues; repayment of loan..... 362

4629.12. Loan from General Fund; repayment. 363

4629.13. Use of moneys in fund for cashflow loans to General Fund; interest..... 363

**PERTINENT EXCERPTS FROM PROTECTION OF FOREST, RANGE AND FORAGE LANDS;
PROHIBITED ACTIVITIES Public Resources Code, Division 4, Chapter 6** 364

4427. Operation of fire causing equipment. 364

4428. Use of hydrocarbon powered engines near forest, brush or grass covered lands without maintaining firefighting tools. 364

4429. Camps or local headquarters, firefighting equipment. 365

4431. Gasoline powered saws, etc.; firefighting equipment. 365

4442. Spark arresters or fire prevention measures; requirement; exemptions. 365

**PERTINENT EXCERPTS FROM THE WILD AND SCENIC RIVERS ACT. Public Resources Code,
Division 5, Chapter 1.4**..... 366

5093.50. Legislative declaration. 366

5093.52. Definitions. 366

5093.53. Classification of rivers..... 366

5093.54. Components of systems. 367

5093.541. Tributaries of Smith River..... 371

5093.542. McCloud River; legislative findings and declarations..... 372

5093.545. Revision and adoption of classification of rivers..... 373

5093.68. Special treatment areas; provisions applicable; timber operations stop orders. 379

5093.70. Mill and Deer Creeks; findings and declarations; dam, reservoir, diversion, or other impoundment facilities; protection, restoration, or enhancement of fishery resources; water rights and historic use practices..... 380

**PROFESSIONAL FORESTERS LAW Public Resources Code Sections 750-783, Division 1,
Administration, Chapter 2.5 Department of Forestry and Fire Protection.** 382

Article 3. Professional Foresters..... 382

750. Short title..... 382

751. Purpose..... 382

752. Professional forester; scope of license and expertise. 382

753. Forestry. 382

754. Forested landscapes..... 383

755. Person. 383

756. Supervision of forestry work by registered professional forester. 383

757. Landowner; exception..... 383

758. Professional forester not authorized to practice civil engineering, land surveying, or landscape architecture. 383

759. Rules and regulations..... 383

760. Meetings to consider registration matters; time. 383

760.5. Staff personnel; executive officer; civil service. 383

761. Records..... 383

762. Certificates of specialization..... 384

763. Examining committee; membership; duties..... 384

764. Examining committee; compensation; expenses..... 384

765. Examining committee; appeals..... 384

766. Necessity of registration..... 384

767. Application for license; fee..... 384

768. Demonstration of experience and knowledge..... 385

769. Qualifications..... 385

770. Examinations. 385

771. Reexamination. 385

772. Certified specialist; registration; specialties..... 385

773. Licenses and specialty certificates; expiration..... 385

CALIFORNIA FOREST PRACTICE RULES

774. Denial of license; reapplication conditions..... 385
 775. Investigations; suspension or revocation of license. 386
 776. Limitations of actions; law governing..... 386
 777. Mode of discipline..... 386
 778. Causes for disciplinary action. 386
 778.5. Criteria development; disciplinary action..... 386
 779. Violations; misdemeanor. 386
 780. Deposit of fees. 387
 781. Use of fees; emergency expenditure. 387
 782. Fee schedule. 387
 783. Default in payment of renewal fee; effect..... 387

REGISTRATION OF PROFESSIONAL FORESTERS RULES Title 14, California Code of Regulations, Chapter 10. Registration of Professional Foresters..... 388

Article 1. General Provisions..... 388
 1600. Definitions. 388
 1601. Board of Forestry [and Fire Protection] Address..... 388
 1601.1. Determination of Deadlines. 388
 1602. Professional Forestry Practice Defined..... 388
 1602.1. Identity Required of Registered Professional Forester in Charge. 389
 1603. Seal..... 389
 1604. Registration limited to Natural Persons. 389
 1605. Fees. 389
 1606. Address Change..... 390
 1607. Issuance, Expiration and Renewal of Licenses and Certificates. 390
 1608. Withdrawals..... 390
 1610. Delegation of Certain Functions..... 391
 1610.1. Committee Meeting and Reports. 391
 1611. Reciprocity..... 391
 1612. Discipline..... 391
 1612.1. Disciplinary Guidelines..... 391
 1612.2. Notification of Disciplinary Action..... 393
 1613. Felony Substantial Relationship Criteria..... 394
 1614. Criteria for Rehabilitation..... 394

Article 2. Applications..... 395
 1620. Applications. 395
 1620.1. Professional and Personal References. 395
 1620.2. Application Processing..... 395
 1620.3. Evidence of Qualifying Experience. 395
 1621. Evaluation of Qualification to Take the Examination..... 395
 1621.1. Qualifying Forestry Work Experiences..... 396
 1621.2. Non-Qualifying Forestry-Related Work Experience..... 396
 1621.3. Work Experience Obtained While In a Degree Program. 396
 1621.4. Substitution of Education for Experience. 397
 1622. Three Years of ‘Having Charge of Forestry Work,’ or ‘Under the Supervision of a Person Registered.’ 397
 1622.2. Contracting Forestry Work Experience..... 398
 1626. Denial of Application..... 398
 1628. Abandoned Applications..... 398

Article 2.5. Applications for Registration Without Examination..... 398

Article 3. Examinations..... 398
 1640. Notification of Authorization to Take Examination. 398
 1640.1. Study Exams. 399
 1640.2. Scheduling Examinations..... 399

CALIFORNIA FOREST PRACTICE RULES

1640.3. Examinations Prescribed. 399
1641. Examination Facilities. 399
1642. Examination Irregularities. 399
1643. Successful Completion of Examination. 399
1644. Denial of Application for Failure to Pass Examination. 399
1645. Inspection of Examination Papers. 400
1647. Appeal Procedure. 400

Article 4. Miscellaneous. 400
1650. Specialties. 400
1651. Certified Rangeland Management Specialty. 401

SURFACE MINING AND RECLAMATION ACT OF 1975 PRC, Division 2, Chapter 9 403

Article 1. General Provisions 403
2710. Chapter Title. 403
2711. Legislature Findings. 403
2712. Legislature Intent. 403
2713. Private Property Rights. 403
2714. Exemptions. 403

STATE MINING AND GEOLOGY BOARD RECLAMATION REGULATIONS. California Code of Regulations, Title 14, Division 2, Chapter 8, Subchapter 1. 404

Article 9. Reclamation Standards. 404
3704. Performance Standards for Backfilling, Regrading, Slope Stability, and Recontouring. 404
3706(d). Performance Standards for Drainage, Diversion Structures, Waterways, and Erosion Control. 404

Board of Forestry Technical Rule Addendum No. 1 405

CALIFORNIA FOREST PRACTICE RULES

**CALIFORNIA FOREST PRACTICE RULES 2024
Title 14, California Code of Regulations, Chapter 4,**

SUBCHAPTER 1 ABBREVIATIONS AND DEFINITIONS

Article 1 Abbreviations and Definitions

895 Abbreviations Applicable Throughout Chapter

B & M	Baseline and Meridian reference lines running in true EW and NS directions used in U.S. General Land Survey
CAA	Confidential Archaeological Addendum
CAL	Confidential Archaeological Letter
CAL FIRE	California Department of Forestry and Fire Protection
CCR	California Code of Regulations
CDFW	California Department of Fish and Wildlife (formerly DFG)
CEQA	California Environmental Quality Act (PRC § 21000 et seq.)
CGS	California Geological Survey
cm	Centimeter(s)
CMZ	Channel Migration Zone
dbh	The average diameter of a tree measured outside bark, at breast height, a point 4.5 feet (1.37 m) above the average ground level.
def.	Definition
DFG	California Department of Fish and Game
E	true cardinal direction East
EIR	Environmental Impact Report as defined in Public Resources Code Section 21061
F&GC	Fish and Game Code
FPA	Z'berg-Nejedly Forest Practice act of 1973 and amendments thereto (Public Resources Code Section 4511 et seq.)
ft	foot or feet
GHG	Greenhouse Gas
Gov. C.	Government Code
H	Humboldt (used in combination with B & M)

CALIFORNIA FOREST PRACTICE RULES

ha.	hectare(s)
HCP	Habitat Conservation Plan
in.	inch or inches
LTO	Licensed Timber Operator
m	Meter or meters
MD	Mount Diablo (used in combination with B & M)
MTHP	Modified Timber Harvest Plan
MTHP-FHR	Modified Timber Harvesting Plan for Fuel Hazard Reduction
N	true cardinal direction North
NAHC	Native American Heritage Commission
NMFS	National Marine Fisheries Service
NTMP	Nonindustrial Timber Management Plan
PRC	Public Resources Code
PTEIR	Program Timberland Environmental Impact Report
PTHP	Program Timber Harvesting Plan
QMD	Quadratic Mean Diameter
R	Range: a row of townships, six miles in width, between two successive meridian lines of the U.S. General Land Survey.
ref.	Refer, reference
RMP	Road Management Plan
RPF	Registered Professional Forester
RWQCB	Regional Water Quality Control Board
S	true cardinal direction South
SB	San Bernardino (used in combination with B & M)
Sec.	Section
SOD	Sudden Oak Death
SOE	Spotted Owl Expert

CALIFORNIA FOREST PRACTICE RULES

SWRCB	State Water Resources Control Board
T	Township: a tier of ranges, six miles in length between two successive standard parallels as used in the U.S. General Land Survey.
THP	Timber Harvesting Plan
TPZ	Timberland Production Zone (Ref. Government Code Section 51104(g))
TRPA	Tahoe Regional Planning Agency
USFWS	U. S. Fish and Wildlife Service
USGS	United States Geological Survey
W	true cardinal direction West
WFMP	Working Forest Management Plan
WHR	California Wildlife Habitat Relationships System
WLPZ	Watercourse and Lake Protection Zone
WTL	Watercourse Transition Line

CALIFORNIA FOREST PRACTICE RULES

895.1. Definitions

The definitions contained in the Z'berg-Nejedly Forest Practice Act of 1973 as amended (commencing with PRC § 4511) shall apply to this chapter, as well as the following definitions, unless the context clearly requires otherwise.

Abandoned Road means a Logging Road on which proactive measures have been applied to effectively remove it from the Permanent Road Network.

Abandonment means implementing measures to effectively remove an existing Logging Road, Landing, or Logging Road Watercourse crossing from the Permanent Road Network.

Act means the Z'berg-Nejedly Forest Practice Act of 1973 as currently amended (commencing with Section 4511 of the Public Resources Code).

Active Channel Width means the width of a Watercourse channel at the height of the Active Channel. The Active Channel width may be indicated by absence of vegetation or the presence of actively scoured sediment (see Figure 4).

Figure 4: Depiction of channel width at Bankfull stage compared to Active Channel width (modified from California Department of Fish and Game's (CDFG) Salmonid Stream Habitat Restoration Manual, Taylor and Love, 2003).

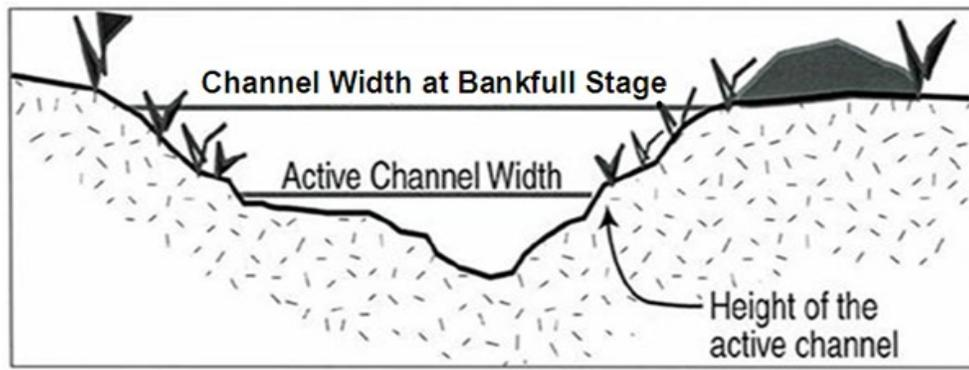

Active Nest means a bird Nest Site at which breeding efforts have recently occurred as determined by the CDFW, as specified below:

For the Great Blue Heron, Great Egret, recently means within the last two years.

For the Golden Eagle, Osprey, Goshawk, recently means within the last three years.

For the Bald Eagle and Peregrine Falcon, recently means within the last five years.

Nests that have not been used within this time period are considered abandoned.

Activity Center means a known northern spotted owl site documented from detections, pursuant to the USFWS document "Protocol For Surveying Proposed Management Activities That May Impact Northern Spotted Owls" revised January 9, 2012, herby incorporated by reference.

(a) An Activity Center is established by:

(1) Resident Single Status is established by:

(A) The presence or response of a single owl within the same general area on three or more occasions within a breeding season, with no response by an owl of the opposite sex after a complete survey;

(B) Multiple responses over several years (i.e., two responses in year one (1) and one response in year 2, from the same general area).

(2) Pair Status Unknown is where the presence or response of two birds of the opposite sex is detected but pair status cannot be determined and where at least one member must meet the resident single requirements.

(3) Pair Status wherein a male and female are heard and/or observed (either initially or through their movement) in proximity (less than one-quarter mile apart) to each other on the same visit; or a male takes a mouse to a female; or a female is detected on the nest; or one or both adults are observed with young.

CALIFORNIA FOREST PRACTICE RULES

(4) Unoccupied Status where no responses have been obtained from a previously identified northern spotted owl Activity Center after three (3) years of survey, barring other evidence to the contrary.

An Activity Center with unoccupied status will not be considered an Activity Center when it has been evaluated and a determination made by the Director. The determination shall be based upon available information on survey history, habitat conditions within the home range, and changes to habitat that may have occurred since the northern spotted owl site was first identified.

Adequate Site Occupancy means the range of stocking levels which provide a balance between the largest number of trees per acre capable of maximum individual tree growth on future crop trees and maximum overall stand growth. This balance is achieved when stocking levels are within Zones 2 and 3 of the Langsaeter curve, as shown in "The Practice of Silviculture", by David Smith (1962).

Alternative Prescription means a written analysis of preharvest and postharvest timber stand conditions and a description of the silvicultural practices and systems to be used in lieu of the standard methods.

Approved and Legally Permitted Structure means, only structures that are designed for human occupancy and garages, barns, stables, and structures used to enclose fuel tanks.

Approved and Legally Permitted Habitable Structure means a building that contains one or more dwelling units or that can be occupied for residential use. Buildings occupied for residential use include single family homes, multi-dwelling structure, mobile and manufactured homes, and condominiums. A habitable structure does not include commercial, industrial, or incidental buildings such as detached garages, barns, outdoor sanitation facilities, and sheds.

Appurtenant Road means a Logging Road under the ownership or control of the Timber Owner, Timberland Owner, Timber Operator, or plan submitter that will be used for log hauling.

Archaeological Coverage Map means the map or maps required as part of a Confidential Archaeological Addendum or a Confidential Archaeological Letter pursuant to 14 CCR §§ 929.1 [949.1,969.1] (c)(9) and 1052(a)(10). The map(s) shall contain a north arrow, a scale, and accurately display the project boundary, the Site Survey Area showing survey intensity(ies), and specific location of all archaeological and historical sites identified within the Site Survey Area. The map(s) must be on a 1:1 scale copy of a USGS 7.5' quadrangle(s), or digitally generated topographical equivalent. Additional maps at other scales may be required to more accurately display required information or increase clarity.

Average Slope means the arithmetic average of a sample of slopes taken systematically over the area to which the average is to be applied.

Bankfull stage means the stage that occurs when discharge fills the entire channel cross section without significant inundation of the adjacent floodplain, and has a recurrence interval of 1.5 to 2.0 years.

Basal Area Per Acre, pursuant to PRC § 4528(a), means the sum of the cross-sectional areas at breast height of the tree stems of commercial species per acre.

Beneficial Functions of Riparian Zone means the specific role of the Riparian zone to provide protection for water temperature control, streambed and flow modification by large woody debris, filtration of organic and inorganic material, upslope stability, bank and channel stabilization and vegetative structure diversity for fish and wildlife habitat.

Beneficial Use means those uses of water as defined by Section 13050(f) of the Water Code and as described in the applicable Water Quality Control Plan.

Berm means a curb, dike, or linear mound of earth that is constructed to control water and direct roadway runoff waters or that has developed through road grading activities.

Board, pursuant to PRC § 4521.3, means the State Board of Forestry and Fire Protection.

Broadcast Burning means the use of fire to burn over a designated area to prepare it for regeneration, to reduce fuel hazard, or to achieve a management objective consistent with the Act and Rules. It does not include burning of organic matter which is piled during mechanical Site Preparation.

Brood Material as used in these Rules refers to any cut or downed portion of a tree's stem greater than three inches with intact undeteriorated bark.

Buffer Zone means the area of protection surrounding a Nest Tree in which Timber Operations must be conducted in accordance with the provisions set forth in these regulations. A Buffer Zone does not constitute a Special Treatment Area.

CALIFORNIA FOREST PRACTICE RULES

Cable Roads means the path followed by logs being yarded by a cable system.

Cable Yarding means that system of Skidding (transporting) logs by means of cable (wire rope) to the Yarding machine (yarder) or a Landing while the yarder remains stationary.

CAL FIRE Review Team Office means the office of the Director's representative(s) or Chairperson(s) as listed under 14 CCR § 1032 (ref. 1037.5 and 1090.19).

Canopy means the more or less continuous cover of branches and foliage formed collectively by the crowns of adjacent trees and other woody species.

Channel Migration Zone means the area where the main channel of a Watercourse can reasonably be expected to shift position on its floodplain laterally through avulsion or lateral erosion during the period of time required to grow forest trees from the surrounding area to a mature size, except as modified by a permanent levee or dike. The result may be the loss of beneficial functions of the Riparian zone or Riparian habitat (see Figure 1).

Figure 1. Plan view diagram of a simple Channel Migration Zone designation.

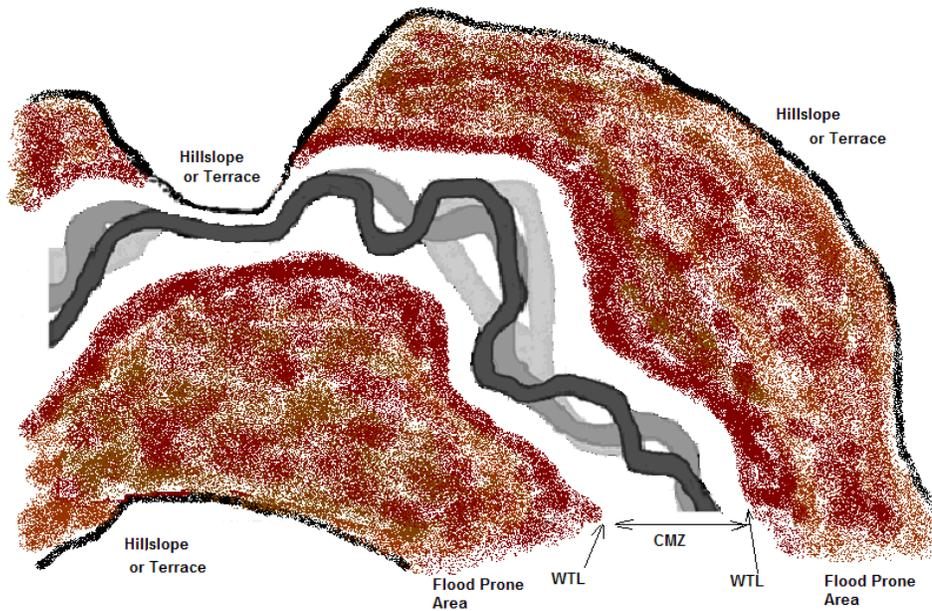

Channel Zone means that area located between the Watercourse transition lines.

Coastal Commission Special Treatment Area: (For the Coast Forest District:) means an identifiable and geographically bounded forest area designated within the Coastal Zone that constitutes a significant wildlife and/or plant habitat area, area of special scenic significance, and any land where Timber Operations could adversely affect public recreation areas or the biological productivity of any wetland, estuary, or Stream especially valuable because of its role in a coastal ecosystem¹ (Ref.: Sec. 31118.5, PRC).

¹ All Coastal Commission Special Treatment Areas were adopted by the Coastal Commission on July 5, 1977, and they include several specially identified areas, Buffer Zones adjacent to designated highways within Coastal Scenic View Corridors, and Buffer Zone adjacent to publicly owned preserves and recreation areas. Maps or designations of Coastal Commission Special Treatment Areas are on file in Department offices in the Coast Forest District. Coastal Commission Special Treatment Areas have been designated according to the following criteria:

- A. Scenic View Corridors,
- B. Sites of significant scenic value,
- C. Wetlands, lagoons, Streams, estuaries, and marine environments,
- D. Significant animal and plant habitat areas,
- E. Recreation areas.

The Coastal Commission has also set forth in its designations special management objectives considered essential by the Coastal Commission for the protection of public values within the Coastal Zone.

[Footnote continues on the next page]

CALIFORNIA FOREST PRACTICE RULES

The following is a listing of the Coastal Commission Special Treatment Areas. In parentheses following the name of each area are capital letters indicating the specific criteria as listed above. The letters referencing the criteria are listed in order of priority of the significance of the various criteria applicable to the area.

(a) Del Norte County: Elk Creek Valley (C), Sitka Spruce Grove (D,A), False Klamath Cove (B,A), Klamath River (B,A,C).

(b) Humboldt County: Freshwater Lagoon (B,C,E), Stone Lagoon (A,B,C,E), Big Lagoon (A,C,B), Big Lagoon Bog (B,C,E), Agate Beach Bluff (B,A), Mattole River (B,C). The King Range National Conservation Area forestlands that parallel the beach: All private inholdings that are within view of the beach trail that are in the recreational zoned western slopes.

(c) Mendocino County: Usal Creek (A,C), Rockport Beach (B), Hardy Creek Knoll (B), Westport (B), Ten Mile River (B,C), Noyo River (A,B,C), Casper and Doyle Creeks (A), Big River (A,B,C,E), Albion River (A,B,C,D), Navarro River (B,C,A), Navarro to Irish Beach Terrace (A,B), Elk Creek (C,B), Gualala River (B,C).

(d) Sonoma County: Gualala River (B,C), Sea Ranch Area (A), Stewarts Point Area (A), Horseshoe Cove Area (C,B,E), Stockoff Creek and Kolmer Gulch (B,C,D), Fort Ross (A,B), Mill Gulch (A,B), Timber Gulch (A,B), Russian Gulch (A), Sawmill Gulch (A), Sheephouse Creek (A,C,D), Duncan Mills Marsh (A,C,D), South Side of the Russian River (A,B,C,D,E), Willow Creek Headwaters (C,D), Jenner Gulch (C,D), Slaughterhouse Gulch (A,D), Furlong Gulch (A,D), Scotty Creek (C,D), Rough Creek (C,D).

(e) San Mateo County: San Pedro Valley (A), South Montara Mountain (A,B), Butano Panorama (B,E), Ano Nuevo Uplands (A,B,E).

(f) Santa Cruz County: Ano Nuevo Uplands (A,B,E), Waddell Creek (A,B,C,E), Bonny Doon Botanic Area (B,D), Molino Creek (A,B).

(g) Buffer Zones within Coastal Scenic View Corridors in Del Norte, Humboldt and Mendocino Counties.

(1) Del Norte County. Highway 101 from Crescent City to Smith River town along the west side of the hwy.

(2) Humboldt County.

(A) Highway 101 from the Moonstone-Westhaven Exit to Big Lagoon Bridge along both sides of the hwy.

(B) Old Highway 101 from Trinidad north to Patrick's Point State Park entrance along both sides of the rd.

(3) Mendocino County. Highway 1 from Ten Mile River to Sonoma County line along both sides of the hwy.

(h) Buffer Zones adjacent to all publicly owned preserves and recreation areas, including national, state, regional, county, and municipal parks

Coastal Commission Special Treatment Area: (For the Southern Forest District:) An identifiable and geographically bounded forest area designated within the Coastal Zone that constitutes a significant wildlife and/or plant habitat area, area of special scenic significance, and any land where Timber Operations could adversely affect public recreation areas or the biological productivity of any wetland, estuary, or Stream especially valuable because of its role in the coastal ecosystem. Special Treatment Areas were adopted by the Coastal Commission on July 5, 1977. Maps or designations of "Coastal Commission Special Treatment Areas" are on file in the Department offices within the Southern Forest District.² (Ref. Sec. 31118.5, PRC).

² Coastal Commission Special Treatment Areas have been designated according to the following criteria:

A. Scenic View Corridors

B. Sites of Significant Scenic Value

C. Wetlands, Lagoons, Streams, Estuaries, and Marine Environments

D. Significant Animal and Plant Habitat Areas

E. Recreation Areas

The Coastal Commission has also set forth in its designations special management objectives considered essential by the Coastal Commission for the protection of public values within the Coastal Zone.

The following is a listing of the Coastal Commission Special Treatment Areas. In parentheses following (B), Partington Canyon (B,E) McWay Canyon (B), Anderson Canyon (A,B), Burns Creek (A), Hot Springs Canyon (B,E), Lucia Area Canyonmouths (B,E), Mill Creek (B,E).

(b) San Luis Obispo County. Cambria Monterey Pines (A,B).

(c) Publicly Owned Preserves and Recreation Areas. Coastal Commission Special Treatment Areas include those forested areas within the Coastal Zone within 200 ft. (60.96 m) of a publicly owned preserved and recreation areas including national, state, regional, county, and municipal parks.

CALIFORNIA FOREST PRACTICE RULES

Codominants means trees with crowns forming the general level of the forest canopy and receiving full light from above, but comparatively little light from the sides. Codominants usually have medium sized crowns, but are crowded on the sides.

Commercial Species (For the Coast Forest District:) means those species found in group A and those in group B that are found on lands where the species in Group A are now growing naturally or have grown naturally in the recorded past.

Group A:

- coast redwood (*Sequoia sempervirens*)
- Douglas-fir (*Pseudotsuga menziesii*)
- grand fir (*Abies grandis*)
- western hemlock (*Tsuga heterophylla*)
- western redcedar (*Thuja plicata*)
- bishop pine (*Pinus muricata*)
- Sitka spruce (*Picea sitchensis*)
- western white pine (*Pinus monticola*)

- incense cedar (*Calocedrus decurrens*)
- Port Orford cedar (*Chamaecyparis lawsoniana*)
- California red fir (*Abies magnifica*)
- white fir (*Abies concolor*)
- Jeffrey pine (*Pinus jeffreyi*)
- ponderosa pine (*Pinus ponderosa*)
- sugar pine (*Pinus lambertiana*)

Group B:

- tanoak (*Notholithocarpus densiflorus*)
- red alder (*Alnus rubra*)
- white alder (*Alnus rhombifolia*)
- California black oak (*Quercus kelloggii*)
- Monterey pine (*Pinus radiata*)

- golden chinkapin (*Castanopsis chrysophylla*)
- pepperwood (*Umbellularia californica*)
- Oregon white oak (*Quercus garryana*)
- Pacific madrone (*Arbutus menziesii*)

Commercial Species (For the Northern Forest District:) means those species found in group A and those in group B that are found on lands where the species in group A are now growing naturally or have grown naturally in the recorded past.

Group A:

- sugar pine (*Pinus lambertiana*)
- coast redwood (*Sequoia sempervirens*)
- ponderosa pine (*Pinus ponderosa*)
- Jeffrey pine (*Pinus jeffreyi*)
- western white pine (*Pinus monticola*)
- lodgepole pine (*Pinus contorta*)

- white fir (*Abies concolor*)
- California red fir (*Abies magnifica*)
- noble fir (*Abies procera*)
- Douglas-fir (*Pseudotsuga menziesii*)
- incense cedar (*Calocedrus decurrens*)
- Port Orford cedar (*Chamaecyparis lawsoniana*)

Group B:

- knobcone pine (*Pinus attenuata*)
- gray pine (*Pinus sabiniana*)
- California black oak (*Quercus kelloggii*)
- Oregon white oak (*Quercus garryana*)
- tanoak (*Notholithocarpus densiflorus*)
- mountain hemlock (*Tsuga mertensiana*)
- Brewer spruce (*Picea breweriana*)
- Englemann spruce (*Picea engelmannii*)

- Sierra redwood (*Sequoiadendron giganteum*)
- golden chinkapin (*Castanopsis chrysophylla*)
- foxtail pine (*Pinus balfouriana*)
- white alder (*Alnus rhombifolia*)
- Monterey pine (*Pinus radiata*)
- Pacific madrone (*Arbutus menziesii*)
- California laurel (*Umbellularia californica*)
- western juniper (*Juniperus occidentalis*)

Commercial Species (For the Southern Forest District:) means those species found in group A and those in group B that are found on lands where the species in group A are now growing naturally or have grown naturally in the recorded past.

Group A:

- Coulter pine (*Pinus coulteri*)
- Jeffrey pine (*Pinus jeffreyi*)
- ponderosa pine (*Pinus ponderosa*)
- sugar pine (*Pinus lambertiana*)
- lodgepole pine (*Pinus contorta*)
- Sierra redwood (*Sequoiadendron giganteum*)
- mountain hemlock (*Tsuga mertensiana*)

- Douglas-fir (*Pseudotsuga menziesii*)
- California red fir (*Abies magnifica*)
- white fir (*Abies concolor*)
- incense cedar (*Calocedrus decurrens*)
- coast redwood (*Sequoia sempervirens*)
- western white pine (*Pinus monticola*)

Group B:

CALIFORNIA FOREST PRACTICE RULES

-white alder (*Alnus rhombifolia*)

-cottonwood (*Populus fremontii*)

-tanoak (*Notholithocarpus densiflorus*)

-Pacific madrone (*Arbutus menziesii*)

-California black oak (*Quercus kelloggii*)

-Monterey pine (*Pinus radiata*)

Community Fuelbreak Area means a shaded fuelbreak approved by a public fire agency as part of a fire prevention plan for fire protection, ignition management, prefire management or other fire defense improvements. Within a shaded fuelbreak, vegetation is managed to reduce the potential for wildfire damage and provides a direct benefit to defensible space as defined in 14 CCR 1271. Community fuelbreak areas include defensible space areas within 200 feet of approved and legally permitted structures, as defined in 14 CCR 895.1, and those areas comprising systems of fuelbreaks that are designed or approved by a public fire agency as part of a fire prevention plan.

Compatible Use means uses which do not significantly detract from the use of the property for, or inhibit, growing and harvesting timber, and shall include those specified in Government Code 51104(h) unless in specific instances such use would be contrary to this definition.

Concentration means an accumulation of Slash, limbs, tops, slabs or other logging debris that exceeds 30 inches (76.2 cm) in height above the ground and covers more than 100 square feet (9.29 m/sq) of surface area except that individual logs not associated with other logging debris which exceed these dimensions shall not be considered a concentration of Slash or logging debris.

Connected Headwall Swale means a geomorphic feature consisting of a concave depression with convergent slopes, typically of 65 percent or greater steepness that is connected to a Watercourse or lake by way of a continuous linear depression and that has been sculpted over geologic time by shallow landslide events. The slope profile is typically smooth and unbroken by benches, but may be interrupted by recent landslide deposits or scars. Emergent groundwater and wet areas may exist at the base of the swale. Soil and colluvium depth is typically greatest at the axis of the swale, thinning to either side.

Confidential Archaeological Addendum means the archaeological and historical resources survey and Impact assessment report prepared for a proposed timber operation. The addendum is confidential to the extent permitted pursuant to Government Code §§ 6254(r) and 6254.10. It shall not be included in any document provided to the public. It shall contain all information required by 14 CCR §§ 929.1, 929.2, 929.3, 929.7, 949.1, 949.2, 949.3, 949.7, 969.1, 969.2, 969.3, 969.7.

Confidential Archaeological Letter means the archaeological and historical resources survey and Impact assessment prepared for an Emergency Notice covering three acres or more in size. It is included with the submittal of the Emergency Notice to the Director and contains all information required by 14 CCR § 929.1 [949.1, 969.1] (c)(2), (3), (7), (8), (9), (10), and (11), including site records, as required pursuant to 14 CCR §§ 929.1 [949.1, 969.1] (g) and 929.5 [949.5, 969.5]. The information may be presented in either a letter or report format. It is confidential to the extent permitted pursuant to Government Code §§ 6254(r) and 6254.10 and shall not be included in any document provided to the public.

Confined Channel means a Watercourse with an incised channel that does not shift position on a floodplain, the channel has no contiguous flat, flood prone areas, and the width of the valley floor is less than 2 times the channel width at Bankfull stage.

Countable Tree, pursuant to PRC § 4528(b), means a tree that can be used in calculating the degree of stocking under the following criteria:

(1) The tree must be in place at least two growing seasons.

(2) The tree must be live and healthy.

(3) The tree must have at least one-third of its length in live crown, except in pure stands of Douglas fir the tree must have at least one-fourth of its length in live crown.

(4) The tree must be a commercial species from a local seed source or a seed source which the registered professional forester determines will produce commercial trees physiologically suited for the area involved.

Critical Dip means a constructed dip or low point across a Logging Road surface down grade from, or over, a Logging Road Watercourse crossing that functions to prevent crossing overflow from draining down the road and minimizes fill erosion.

Critical Period means the time of year when the special Timber Operations practices set forth in these regulations are required to minimize nesting disturbance to a species of special concern.

Crop of Trees (within the meaning of PRC 4526), any number of trees which can be harvested

CALIFORNIA FOREST PRACTICE RULES

commercially.

Crowning means creating a road surface with a convex cross sectional profile that drains runoff toward both sides of the road.

Cumulative Impacts means those Impacts as defined in 14 CCR 15355.

Current Archaeological Records Check means a review of the State's archaeological and historic resource files conducted at the appropriate Information Center of the California Historical Resource Information System for the area which could be affected by Timber Operations. The Office of Historic Preservation, which is within the Department of Parks and Recreation, has the address for the regional Information Center a person must contact. The records check must have been conducted within five years prior to the date a THP, NTMP, WFMP, or Emergency Notice of 3 acres or more is submitted to the Director.

Cutting Method: means silvicultural method within the Southern Subdistrict of the Coast Forest District.

Damaging Effects means demolition, destruction, relocation, or significant alteration of an archaeological or historical site or resource before the significance of the site is determined.

Danger Tree means any tree located on or adjacent to a utility right-of-way or facility that could damage utility facilities should it fall where: (1) the tree leans toward the right-of-way, or (2) the tree is defective because of any cause, such as: heart or root rot, shallow roots, excavation, bad crotch, dead or with dead top, deformity, cracks or splits, or any other reason that could result in the tree or a main lateral of the tree falling. See Chapter VII, *Hazardous Tree Identification, Powerline Fire Prevention Field Guide-1977*, A Joint Publication of the California Department of Forestry and Fire Protection, U.S. Forest Service, and U.S. Bureau of Land Management.

Deactivated Road means a Logging Road that is part of the Permanent Road Network where measures have been implemented to prevent active use by logging trucks and standard production four-wheel drive highway vehicles.

Deactivation means implementing measures necessary to prevent the active use of an existing Logging Road, Landing, or Logging Road Watercourse crossing.

Decadent and Deformed Trees of Value to Wildlife means trees, either conifers or hardwoods, that are not countable per PRC § 4528 but which exhibit characteristics of substantial value to wildlife including but not limited to such features as broken tops, dead tops, forked tops, nests, mistletoe clumps, substantial decay and cavities.

Department means the Department of Forestry and Fire Protection or CAL FIRE.

Diameter (when measuring standing live trees), the average diameter of a tree measured outside the bark, at breast height, a point 4.5 feet (1.37m) above the average ground level.

Director means the Director of Forestry and Fire Protection.

Diseased Trees means trees which have abnormal physiological conditions or structural changes that result in a substantial adverse effect on the trees' health or threatens to spread the disease, thus threatening the sustained health of surrounding trees. These conditions or structural changes express characteristic signs or symptoms and are caused by identifiable biotic or abiotic agents including, but not limited to, fungi, bacteria, insects, parasitic plants, vertebrates, lightning, fire and mechanical wounds.

District, pursuant to PRC § 4523, means a forest district.

Ditch Drain means a drainage structure or facility which will move water from an inside road ditch to an outside area.

Domestic Water Use means the use of water in homes, resorts, motels, organization camps, developed campgrounds, including the incidental watering of domestic stock for family sustenance or enjoyment and the irrigation of not more than one half acre in lawn, ornamental shrubbery, or gardens at any single establishment. The use of water at a developed campground or resort for human consumption, cooking or sanitary purposes is a domestic use.

Dominants means trees with well-developed crowns extending above the general level of the forest canopy and receiving full light from above and partly from the sides.

Drainage Facilities means facilities constructed to control water, including, but not limited to, fords, inside ditches, waterbreaks, outsloping and rolling dips.

Drainage Structure means a structure installed to control, divert or to cross over water, including,

CALIFORNIA FOREST PRACTICE RULES

but not limited to, culverts, bridges and ditch drains.

Dunning's Classification Although initially devised exclusively for pine, here is intended to apply to all commercial coniferous species and means a system of tree classification based on maturity of trees, age, position of tree crown in stand, shape of top, diameter, density of foliage and risk or susceptibility of tree to insect and other mortality where trees are classed as follows:

Class 1. Tree immature, 60 to 150 years of age, crown dominant or extending above general level of the crown cover, top pointed, d.b.h. up to 30 in. (76.2 cm), foliage dense and risk good.

Class 2. Tree immature, 60 to 150 years of age, crown codominant or equal to general level of the crown cover, top pointed, d.b.h. up to 24 in. (61.0 cm), foliage dense and risk good.

Class 3. Tree mature, 150 to 300 years of age, crown dominant or extending above general level of the crown cover, top rounded, d.b.h. 18 in. (45.7 cm) to 40 in. (101.6 cm), foliage moderately dense and risk fair to good.

Class 4. Tree mature, 150 to 300 years of age, crown codominant or equal to general level of the crown cover, top rounded and risk poor to fair.

Class 5. Tree overmature, over 300 years of age, crown dominant or extending above the general level of the crown cover, top flat, foliage thin, and risk poor.

Class 6. Tree immature, 60 to 150 years of age, crown intermediate to or suppressed by the general level of the crown cover, top pointed, d.b.h. 12 in. (30.5 cm) to 15 in. (38.1 cm), foliage moderately dense and risk fair to good.

Class 7. Tree mature or overmature, over 150 years of age, crown intermediate or suppressed by the general level of the crown cover, top flat, d.b.h. rarely over 18 in. (45.7 cm), foliage sparse and risk poor (Ref. Sec. 4531, PRC).

Dying Trees means trees which exhibit one or more of the following: fifty percent or more of the foliage-bearing crown is dead or fading in color from a normal green to yellow, sorrel, or brown, excluding normal autumn coloration changes; successful bark beetle attacks with indications of dead cambium and brood development distributed around the circumference of the bole; seventy-five percent or more of the circumference of the lower bole is girdled by wildlife; or trees designated by an RPF as likely to die within one year.

Effects means effects and Impacts as defined in 14 CCR 15358.

Emergency means those conditions that will cause waste or loss of timber resources to the Timber Owner that may be minimized by immediate harvesting of infected, infested or damaged timber or salvaging down timber; or those conditions that will cause appreciable financial loss to the Timber Owner that may be minimized by immediate harvesting of timber.

Energy Dissipator means a device or material used to reduce the energy of flowing water.

Equipment Exclusion Zone (EEZ) means the area, as explained in the THP, where heavy equipment associated with Timber Operations is totally excluded for the protection of water quality, the beneficial uses of water, and/or other forest resources.

Equipment Limitation the term used when the use of timber harvesting equipment is to be limited for the protection of water quality, the beneficial uses of water, and/or other forest resources.

Equipment Limitation Zone (ELZ) means the area, as explained in the THP, where heavy equipment associated with Timber Operations is limited for the protection of water quality, the beneficial uses of water, and/or other forest resources.

Erosion Controls means drainage facilities, soil stabilization treatments, road and Landing Abandonment, removal and treatment of Watercourse crossings, and any other features or actions to reduce surface erosion, gully, channel erosion, and mass erosion.

Erosion Hazard Rating means the rating derived from the procedure specified in 14 CCR § 912.5 [932.5, 952.5] designed to evaluate the susceptibility of the soil within a given location to erosion.

Estimated Erosion Potential (For the Northern Forest District:) means the product of the soil and slope values derived from the table in 14 CCR 932.5 or as such product may be modified in accordance "with the instructions contained in that section" (Ref. Sec. 4562, PRC).

Excess Material means excavated material that is not used as a functional part of the road or Landing. Excess material is synonymous with spoils.

Executive Officer means the Executive Officer of the State Board of Forestry and Fire

CALIFORNIA FOREST PRACTICE RULES

Protection authorized by PRC § 739.

Extended Dry Periods means those periods during the winter period when saturated soil conditions do not exist.

Extended Wet Weather Period means the period from October 15 to May 1.

Feasible means capable of being accomplished in a successful manner within a reasonable period of time, taking into account economic, environmental, legal, social and technical factors. With regard to economic feasibility, the issue shall be whether the plan as revised could be conducted on a commercial basis within 5 (five) years of the submission of the plan and not solely on the basis of whether extra cost is required to carry out the alternatives.

Fill means material that is mechanically placed and built up in compacted lifts to form a roadbed or Landing surface. Fill includes the material placed around culverts and related drainage structures at Logging Road Watercourse crossings.

Fire Protection Zone (For the Coast and the Southern Forest District:) means that portion of the logging area within 100 feet (30.48 m) as measured along the surface of the ground, from the edge of the traveled surface of all public roads and railroads; and within 200 feet (60.96 m) as measured along the surface of the ground, from permanently located structures currently maintained for human habitation.

Fire Protection Zone (For the Northern Forest District:) means that portion of the logging area within 100 ft. (30.48 m), as measured along the surface of the ground, from the edge of the traveled surface of all public roads and railroads, and 50 ft. (15.24 m) as measured along the surface of the ground from the traveled surface of all private roads, and within 100 ft. (30.48 m), as measured along the surface of the ground, from permanently located structures currently maintained for human habitation (Ref. Sec. [4562], PRC).

Flood Flow means that magnitude of peak flow that would, on the average, be equaled or exceeded once every specified period of years (e.g., once every 10 years, 50 years, 100 years). This flow shall be estimated by flood flow measurement records and by empirical relationships between precipitation, watershed characteristics, and runoff, and may be modified by direct channel cross-section measurements informed by local experience.

Flood Prone Area means an area contiguous to a Watercourse Channel Zone that is periodically flooded by overbank flow. Indicators of flood prone areas may include diverse fluvial landforms, such as overflow side channels or oxbow lakes, hydric vegetation, and deposits of fine-grained sediment between duff layers or on the bark of hardwoods and conifers. The outer boundary of the flood prone area may be determined by field indicators such as the location where valley slope begins (i.e., where there is a substantial percent change in slope, including terraces, the toes of the alluvial fan, etc.), a distinct change in soil/plant characteristics, and the absence of silt lines on trees and residual evidence of floatable debris caught in brush or trees. Along laterally stable Watercourses lacking a Channel Migration Zone where the outer boundary of the flood prone area cannot be clearly determined using the field indicators above, it shall be determined based on the area inundated by a 20-year recurrence interval flood flow event, or the elevation equivalent to twice the distance between a thalweg riffle crest and the depth of the channel at Bankfull stage. When both a Channel Migration Zone and flood prone area are present, the boundaries established by the Channel Migration Zone supersede the establishment of a flood prone area.

Fluvial means the processes associated with rivers and Streams and the deposits and landforms created by them.

Ford means a Logging Road Watercourse crossing where the road grade dips through the Watercourse channel. This includes but is not limited to one of the following construction types:

Rock-armored crossing means a Logging Road Watercourse crossing where fill is placed in the channel to establish a usable road grade and the outfall of the crossing and road surface are protected against scour by revetment composed of rock.

Rock-fill crossing means a Logging Road Watercourse crossing where rock that is free of fines is placed as fill in the channel to establish a usable road grade through the crossing.

Vented crossing means a Logging Road Watercourse crossing designed to allow low water flow in the stream channel to pass through the structure, usually through a culvert, and high water flow to pass over the roadway.

Native surface crossing means a Logging Road Watercourse crossing where the road

CALIFORNIA FOREST PRACTICE RULES

surface crosses at the natural grade of the channel and the channel surface is composed of stable native material sufficient to support crossing use.

Fuelbreak, pursuant to PRC § 4528(e), means a strip of modified fuel to provide a line from which to work in the control of fire.

Functional Wildlife Habitat means vegetative structure and composition which function to provide essential characteristics for wildlife feeding, reproduction, cover and movement between habitats. The habitat components must be in sufficient quantities and arrangement to support the diverse assemblage of wildlife species that are normally found on or use forestlands within that area. Within this definition the following terms mean:

Function(al): Refers to ecological relationships between both the habitat components and needs of the species which allows for all of the normal life cycle including, migration corridors, genetic pathways, food availability, temperature protection, moisture retention, nutrient cycling, denning, spawning, nesting, and other functions necessary to complete a life cycle.

Composition: Refers to the types, abundance, distribution, and ecological relationships of species of terrestrial and aquatic vegetation within the forest stand including dominance, richness, trophic levels and other population and community features at levels which affect the long-term survival of individual forest species.

Structure: Refers to the physical arrangement of and relationships between living and non-living terrestrial and aquatic components within the forest stand including, age, size, height and spacing of live vegetation in the forest in addition to seeps, spawning gravels, pools, springs, snags, logs, den trees, meadows, canopy coverage, levels of canopies and other physical features necessary to allow species to function.

Good Cause is Shown (as used in PRC 4590), the plan submitter presents facts which describe the factors beyond the control of the plan submitter and his or her agents, such as: market conditions, weather, technical difficulties or natural disaster, that have prevented feasible completion of the timber operation within the effective period of the plan.

Harass means an intentional or negligent act or omission which creates the likelihood of injury to a federally listed wildlife species by annoying it to such an extent as to significantly disrupt normal behavioral patterns which include, but are not limited to, breeding, feeding or sheltering.

Hard Frozen Conditions means those frozen soil conditions where loaded or unloaded vehicles can travel without sinking into the road surfaces to a depth of more than six inches over a distance of more than 25 feet.

Harm means an act where it actually kills or injures a federally listed wildlife species. Such acts may include a significant habitat modification or degradation which actually kills or injures wildlife by significantly impairing essential behavioral patterns, including breeding, feeding or sheltering.

Harvest Area means the area where trees are felled and removed.

Harvesting Method means the process used to cut and remove timber. It may have as its silvicultural objective either stand regeneration or intermediate treatments.

Historic Road means an existing road, including associated Landings and Watercourse crossings, that is not part of the Permanent Road Network and that has not been maintained or proactively abandoned.

Hydric means a soil that formed under conditions of saturation, flooding, or ponding long enough during the growing season to develop anaerobic conditions in the upper portions of the soil profile.

Hydrologic Disconnection means the removal of direct routes of drainage or overland flow of road runoff to a Watercourse or lake.

Impacts means Effects and Impacts as defined in 14 CCR § 15358.

Insloping means shaping the Logging Road or Landing surface to drain toward a cutbank or inside ditch.

Inner Gorge means a geomorphic feature formed by coalescing scars originating from landsliding and erosional processes caused by active Stream erosion. The feature is identified as that area beginning immediately adjacent to the Stream channel below the first break in slope.

Intermediate Treatments means harvests conducted to modify or guide the development of an existing stand of trees, but not to replace (regenerate) the stand with a new one. The treatments involve the removal of trees to allow expansion of the crowns and root systems.

CALIFORNIA FOREST PRACTICE RULES

Intermediates means trees with crowns below the general level of the forest canopy and receiving little light from either above or the sides. Intermediates have minimally-developed crowns and are crowded on the sides.

Ladder Fuels means vegetative fuels that can spread a fire vertically between or within a fuel type.

Lake is a permanent natural body of water of any size, or an artificially impounded body of water having a surface area of at least one acre, isolated from the sea, and having an area of open water of sufficient depth and permanency to prevent complete coverage by rooted aquatic plants.

Lake Tahoe Region means those portions of Placer and El Dorado Counties lying within the authority of the Tahoe Regional Planning Agency.

Lake Transition Line means that line closest to the lake where mesic vegetation is permanently established.

Landing means that area where forest products are concentrated prior to loading for transportation to market.

Late Succession Forest Stands means stands of dominant and predominant trees that meet the criteria of WHR class 5M, 5D, or 6 with an open, moderate or dense canopy closure classification, often with multiple canopy layers, and are at least 20 acres in size. Functional characteristics of late succession forests include large decadent trees, snags, and large down logs.

Layout means a prepared bed into which a tree is felled. A layout is generally constructed by tractor and is intended to reduce the breakage that occurs during the felling of trees.

License, pursuant to PRC § 4524, means a license to engage in Timber Operations issued pursuant to Article 6 (commencing with § 4571 of Chapter 8 of PRC) .

Listed Species means a plant or animal species which is listed as rare, threatened or endangered under federal or state law, or a sensitive species by the Board.

Live and Healthy as used in PRC 4528(b)(2) a tree that is a potential crop tree.

Log Culvert means a drainage structure consisting of logs or logs and fill material placed in a drainage in such a manner as to allow for the passage of water. Also commonly referred to as a "Humboldt crossing".

Logging Area means that area on which Timber Operations are being conducted as shown on the map accompanying the Timber Harvesting Plan, and within 100 feet, as measured on the surface of the ground, from the edge of the traveled surface of appurtenant roads owned or controlled by the Timberland Owner, Timber Operator or Timber Owner, and being used during the harvesting of the particular area. The traveled surface of such appurtenant roads is also part of the logging area.

Logging Road means a road other than a public road used by trucks going to and from Landings to transport logs and other forest products.

Logging Road Surface Drainage Network means the system of drainage facilities and structures associated with Logging Roads, which are used to control, divert, or cross over water.

Long Term Significant Adverse Effect on fish, wildlife, or listed species known to be primarily associated with late succession forest stands means an effect that creates an identifiable trend or set of conditions which provide a substantial level of scientific evidence that a population of one or more species of fish, wildlife, or listed species primarily associated with late succession forest stands will become extirpated from a significant portion of its current range in the Forest District within the planning horizon.

Long Term Sustained Yield means the average annual growth sustainable by the inventory predicted at the end of a 100 year planning period.

Lopping: (For the Coast and Northern Forest Districts:) Severing and spreading of Slash so that no part of it remains more than 30 in. (76.2 cm) above the ground (Ref. Sec. 4551.5, PRC).

Lopping: (For the Southern Forest District:) Severing limbs from the exposed sides of the unutilized portions of trees so that portions of the severed limbs are in contact with the ground (Ref. Sec. 4551.5, PRC).

Lopping for Fire Hazard Reduction means severing and spreading Slash so that no part of it generally remains more than 30 inches above the ground except where a specific rule provides another standard.

Mainline Road means roads on non-federal lands that are used as the primary route for the transportation of forest products that are fed by arterial (secondary) haul roads.

Manmade Watercourse means a Watercourse which is constructed and maintained to facilitate

CALIFORNIA FOREST PRACTICE RULES

man's use of water and includes, but is not limited to, ditches and canals used for domestic, hydropower, irrigation, and other beneficial uses (manmade Watercourses as defined do not include roadside drainage ditches).

Marking means a painted horizontal band or other distinguishing designation which is visible from two sides of a tree, and a stump designation, if required in the THP, which is visible after felling operations.

Meadows and Wet Areas: Those areas which are moist on the surface throughout most of the year and/or support aquatic vegetation, grasses and forbs as their principal vegetative cover.

Mechanical Site Preparation means all Site Preparation activities undertaken by motorized heavy equipment to prepare an area for regeneration.

Minor Deviations means any change, minor in scope, in a plan which can reasonably be presumed not to make a significant change in the conduct of Timber Operations and which can reasonably be expected not to significantly adversely affect Timberland productivity or values relating to soil, water quality, watershed, wildlife, fisheries, range and forage, recreation, and aesthetic enjoyment.

Native Americans means the Native American Heritage Commission and those local Native American tribal groups and individuals to be notified or consulted pursuant to the Forest Practice Rules as defined in the Native American Contact List.

Native American Archaeological or Cultural Site means any archaeological or other cultural resource that is associated with Native Americans. These sites must be identifiable by a specific physical location containing specific physical attributes. Native American archaeological or cultural sites include but are not limited to: village sites, camp sites, petroglyphs, prehistoric trails, quarries, milling stations, cemeteries, ceremonial sites or traditional cultural sites and properties.

Native American Contact List means the list that identifies those Native Americans that must be notified or consulted pursuant to the Forest Practice Rules. The Department shall maintain this list utilizing information and advice provided by the Native American Heritage Commission (NAHC). The list shall identify the appropriate contacts to be notified or consulted during preparation or review of Timber Harvesting Plans. The list shall be organized by counties or portions of counties and shall include all local federally recognized tribal governments. It shall also include other California Native American organizations or individuals that the Department places on the list based upon demonstrated knowledge concerning the location of archaeological or cultural resources within California. The NAHC shall also be included as a required contact for each county on the list to enable the NAHC to complete a check of their Sacred Lands File which is authorized by PRC §§ 5097.94(a) and 5097.95. The list shall be posted on the Department's internet site to make it readily available to RPFs and others needing the list to comply with these Rules. The list shall also be available by mail through written request to the appropriate CAL FIRE Review Team Offices. At least twice annually, the Department shall update the list to provide the most current information. Each update will reflect a new revision date, so users of the list may identify which version of the list they were using.

Nest Site means the geographic area surrounding habitat that includes the Nest Tree(s), perch tree(s), screening tree(s), and replacement tree(s) of a bird species of special concern.

Nest Tree means the tree, snag, or other structure that contains the nest of a species of special concern.

Northern Spotted Owl Breeding Season means the period February 1 through July 31 for the Coast Forest District and February 1 through August 31 for the Northern Forest District.

Northern Spotted Owl Evaluation Area means the following counties: Marin, Napa, Del Norte, Mendocino, Colusa, Tehama (west of Interstate-5), Sonoma, Humboldt, Lake, Trinity, and Glenn (west of Interstate-5) and those portions of Siskiyou and Shasta counties west of the line indicated by the following descriptions: south from the California-Oregon border along the east boundary of Township 48N, Range 2W, MDB&M; thence west along the south boundary of Township 48N, Range 2W, MDB&M; thence south along Secret Spring Road; thence south and east along Meiss Lake Sams Neck Road; thence southwest along U.S. Highway 97; thence, at the southern end of the town of Macdoel, south along Old State Highway to due east of Orr Mountain; thence east and south along Tennant Road to about one half mile south of the town of Tennant; thence east along Forest Highway 77 (44N01) to its junction with Forest Highway 15; thence east along 44N01; thence south along the line dividing Ranges 4E and 5E, MDB&M; thence west along the line dividing Townships 42N and 41N, MDB&M; thence south along the line dividing Ranges 2E and 3E, MDB&M; thence south along State Highway 89; thence west along the Pit River to Shasta Lake;

CALIFORNIA FOREST PRACTICE RULES

thence west along the south shore of Shasta Lake to Interstate 5; thence south along Interstate 5 to the Shasta County line.

Northern Spotted Owl Habitat means those areas with which support the owl's biological needs for breeding, sheltering, or feeding. Plans may use regional information consistent with guidance provided by the listing agency(s) or Director, or may propose alternative standards based upon substantial site-specific information for review and approval by the Director.

Occupied Nest means a nest currently being used by one or more adult birds with eggs or young present.

Outsloping means shaping the road surface to drain toward the outside edge of the Logging Road or Landing.

Overhanging Bank means a condition in which the upper portion of a cut slope Projects (hangs) over the lower portion of a cut slope.

Overstory means that portion of the trees, in a forest of more than one story, forming the upper canopy layers.

Past Projects means previously approved, on-going, or completed Projects which may add to or lessen Impact(s) created by the THP under consideration. These generally include, but may not be limited to, Projects completed within the last ten years.

Perch Tree means a tree or snag identified and designated by the RPF or supervised designee in consultation with the CDFW as utilized periodically by a species of special concern for nesting, territorial defense, or as an approach to its nest or feeding area.

Permanent Road means a Logging Road that is part of the Permanent Road Network and is designed for year-round use. These roads have a surface that is suitable for maintaining a stable operating surface throughout the year.

Permanent Road Network means the permanent, seasonal, temporary, and deactivated roads, including appurtenant roads, that provide the infrastructure necessary for Timber Operations and forest management. Abandoned roads are not part of the Permanent Road Network.

Permanent Watercourse Crossing means a Watercourse crossing that will remain in place when Timber Operations have been completed.

Person, pursuant to PRC § 4525, includes any private individual, organization, partnership, corporation, limited liability company, city, county, district, or the state or any department or agency thereof.

Plan means:

(a) Timber Harvesting Plan (THP) as described in PRC § 4582.

(b) Nonindustrial Timber Management Plan (NTMP) as described in PRC§ 4593.2(e).

(c) Program Timber Harvesting Plan (PTHP) as described in 14 CCR §§ 1092 and 1092.1.

(d) Working Forest Management Plan (WFMP) as described in PRC § 4597.1

Planning Watershed means the contiguous land base and associated watershed system that forms a fourth order or other watershed typically 10,000 acres or less in size. Planning watersheds are used in planning forest management and assessing Impacts. The Director has prepared and distributed maps identifying planning watersheds plan submitters must use. Where a watershed exceeds 10,000 acres, the Director may approve subdividing it. Plan submitters may propose and use different planning watersheds, with the Director's approval. Examples include but are not limited to the following: when 10,000 acres or less is not a logical planning unit, such as on the Eastside Sierra Pine type, as long as the size in excess of 10,000 acres is the smallest that is practical. Third order basins flowing directly into the ocean shall also be considered an appropriate planning watershed.

Predominant Trees are those whose crowns are above the general level of the canopy and are significantly older than the surrounding stand.

Pre-existing Large Wood means, for Class III Watercourses in watersheds with listed anadromous salmonids:

(a) a log or tree segment that is (i) at least 12 inches or greater in diameter outside bark when measured at the small end, (ii) at least six feet in length, (iii) in contact with the ground, and (iv) present prior to Timber Operations.

(b) a root wad that is (i) at least 12 inches or greater in diameter outside bark when measured at the base of the trunk, (ii) in contact with the ground, and (iii) present prior to Timber Operations.

CALIFORNIA FOREST PRACTICE RULES

Prescribed Maintenance Period means the time period, beginning with filing of the work completion report, provided that the report is subsequently approved, during which erosion controls that are required and constructed as part of a Timber Operations must be maintained in a functional condition.

Professional Archaeologist means a person who holds at least a Bachelor of Arts or Science degree in Anthropology or Archaeology from a college or university and has completed at least three years of professional experience in research, writing, or project supervision in archaeological investigation or cultural resource management and protection programs.

Program Timberland Environmental Impact Report (PTEIR) means a Program Environmental Impact Report in compliance with CEQA for ongoing management of Timberlands, including Timber Operations and related land management practices which require permits from public agencies. Subsequent PTHPs shall be tied to a PTEIR.

Program Timber Harvesting Plan (PTHP) means a Timber Harvesting Plan prepared by an RPF which relies upon a PTEIR for CEQA compliance and meets the standards of PRC Section 4581. PTHPs must be within the scope of the PTEIR, the Rules of the board and other applicable state laws.

Project means an activity which has the potential to cause a physical change in the environment, directly or ultimately, and that is: 1) undertaken by a public agency, or 2) undertaken with public agency support, or 3) requires the applicant to obtain a lease, permit, license or entitlement from one or more public agencies. This includes Timber Harvesting Plans.

Properly Functioning Salmonid Habitat means the beneficial functions of the Riparian zone are suitable for all life-history stages of listed anadromous salmonid species that would be expected to occur in specific geomorphic conditions considering spatial and temporal variability.

Public Fire Agency means California Department of Forestry and Fire Protection, United States Forest Service, Bureau of Land Management, and other federal fire protection agencies, counties providing fire protection pursuant to PRC 4129, or city, county, or local fire agencies.

Public Road means a road open to the general public which is: (a) in the State or County road system, or (b) a road on which a public agency has deeded, unlimited easement.

Quality of Water means the level of water quality as specified by the applicable Water Quality Control Plan, including its water quality objectives, policies and prohibitions.

Reasonably Foreseeable Probable Future Projects means Projects with activities that may add to or lessen Impact(s) of the proposed THP including but not limited to: 1) if the project is a THP on land which is controlled by the THP submitter, the THP is currently expected to commence within but not limited to 5 years, or 2) if the project is a THP on land which is not under the control of the THP submitter, the THP has been submitted or on-the-ground work including THP preparation has materially commenced, or 3) if the project is not a THP, and a permit is required from a public agency, and the project is under environmental review by the public agency, or 4) if the project is one which is under-taken by a public agency, the agency has made a public announcement of the intent to carry out the project.

Reconstructed Roads means those existing roads that are to be restored or improved to make useable for hauling forest products.

Reconstructed does not include road maintenance or rehabilitation that does not require substantial change in the original prism of the road.

Reconstruction of Existing Tractor Roads means restoring or improving the surface of pre-existing tractor roads or skid trails in a manner that requires substantial cutting or filling of soil or rock.

Regeneration Method means the process used to secure replacement of a forest stand.

Registered Professional Forester means a person who holds a valid license as a professional forester pursuant to Article 3, Chapter 2, Division 1 of the Public Resources Code.

Replacement Tree means a tree or snag within the Nest Site of a species of special concern identified and designated by the RPF or supervised designee in consultation with the CDFW as being suitable as a replacement for a nest or perch tree should the existing tree become unusable.

Reproduction means young trees of commercial species that are less than 4 in. (10.2 cm) d.b.h., i.e., seedlings and saplings.

Resource Conservation Standards, pursuant to PRC § 4525.3, means the minimum acceptable condition resulting from Timber Operations.

Rigging means the cable (wire rope), blocks, and hood equipment used in Cable Yarding systems.

CALIFORNIA FOREST PRACTICE RULES

Riparian means the banks and other adjacent terrestrial environs of lakes, Watercourses, estuaries, and wet areas, where transported surface and subsurface freshwaters provide soil moisture to support mesic vegetation.

Riparian-Associated Species means those plant, invertebrate, amphibian, reptile, fish, or terrestrial wildlife species that require utilization of Riparian zones during any life history stage.

Rip-Rap means rock or other suitable material placed to prevent or reduce erosion.

Road Approach means the portion of the Logging Road surface that drains overland water flow to the Watercourse crossing.

Road Failure means damage to the roadbed not permitting vehicular passage for hauling of forest products, but does not mean cut bank or fill sloughing incidental to road settling.

Road Maintenance means activities that do not require substantial change to the Logging Road prism to maintain stable operating surfaces, functioning Logging Road drainage facilities and structures, and stable cutbanks and fill slopes. Examples of road maintenance may include rocking a road surface; localized shaping or outslowing; installation and maintenance of rolling and critical dips; restoring functional capacity of inboard ditches, cross drains, or culverts; and repairing water bars.

Road Management Plan means a document submitted as part of a plan that describes the long-term management of a road system in one or more planning watersheds on Timberlands. A RMP identifies, evaluates, and proposes approaches to avoid or mitigate significant environmental effects that could result from the construction, reconstruction, use, maintenance, Abandonment, and management of roads related to forest resource management activities on Timberlands.

Road Management Unit means the part or parts of Timberland ownership(s) that are analyzed together as part of an RMP and may include areas of one or more Timberland ownerships. A Road Management Unit shall be limited to one Forest District unless otherwise approved by the Director. The landowner has the option of including within the Road Management Unit the entire ownership(s) and any areas outside the ownership that the Director agrees are part of a logical Road Management Unit based upon regulatory and ecological factors.

Road Prism means all parts of a road including cut banks, ditches, road surfaces, road shoulders, and road fills.

Rolling Dip means a drainage facility that is constructed to remain effective while allowing passage of motor vehicles at reduced road speeds.

Rules, pursuant to PRC § 4525.5, means the district forest practice Rules adopted by the board, pursuant to the Administrative Procedure Act.

Sampling Area means the area delineated on a map accompanying a report of stocking showing the area sampled by one of the procedures specified in 14 CCR 1072.

Saturated Soil Conditions means that soil and/or surface material pore spaces are filled with water to such an extent that runoff is likely to occur. Indicators of saturated soil conditions may include, but are not limited to: (1) areas of ponded water, (2) pumping of fines from the soil or road surfacing material during Timber Operations, (3) loss of bearing strength resulting in the deflection of soil or road surfaces under a load, such as the creation of wheel ruts, (4) spinning or churning of wheels or tracks that produces a wet slurry, or (5) inadequate traction without blading wet soil or surfacing materials.

Scattered Parcel means a Timberland ownership within a planning watershed is less than 10% of the area of the watershed and does not adjoin a planning watershed where the Timberland ownership is greater than 20% of the watershed.

Screening Trees means those trees or snags identified and designated by the RPF or supervised designee in consultation with the CDFW as necessary to protect Nest Trees of species of special concern from the Impacts of human activities and natural elements.

Seasonal Road means a Logging Road that is part of the Permanent Road Network that is not designed for year-round use. These roads have a surface that is suitable for maintaining a stable operating surface during the period of use.

Seed Tree a thrifty vigorous tree of commercial species of seed bearing age, with full crown, and free from damage caused by Timber Operations and hazard abatement which would impair seed productivity.

Sensitive Species means those species designated by the Board pursuant to 14 CCR 898.2(d). These species are the Bald eagle, Golden eagle, Great blue heron, Great egret, Northern goshawk, Osprey,

CALIFORNIA FOREST PRACTICE RULES

Peregrine falcon, California Condor, Great gray owl, Northern spotted owl, and Marbled Murrelet.

Sidecast means excess earthen material pushed or dumped over the side of a road or Landing.

Significant Adverse Impact on the Environment means a substantial, or potentially substantial, adverse change in any of the physical conditions within the area affected by the project including land, air, water, minerals, flora, fauna, ambient noise, and objects of historic or aesthetic significance. An economic or social change by itself shall not be considered a significant effect on the environment. A social or economic change related to a physical change may be considered in determining whether the physical change is significant.

Significant Archaeological or Historical Site means a specific location which may contain artifacts, or objects and where evidence clearly demonstrates a high probability that the site meets one or more of the following criteria:

(a) Contains information needed to answer important scientific research questions.

(b) Has a special and particular quality such as the oldest of its type or best available

example of its type.

(c) Is directly associated with a scientifically recognized important prehistoric or historic event or person.

(d) Involves important research questions that historical research has shown can be answered only with archaeological methods.

(e) Has significant cultural or religious importance to Native Americans as defined in 14 CCR § 895.1.

Significant Existing or Potential Erosion Site means a location where soil erosion is currently, or there are visible physical conditions to indicate soil erosion may be in the future, discharged to Watercourses or lakes in quantities that violate Water Quality Requirements or result in significant individual or cumulative adverse Impacts to the beneficial uses of water.

Significant new information means substantial changes in the plan or environmental setting, as well as additional data or other information. New data or information added to a plan is not "significant" unless the plan is changed in a way that deprives the public of a meaningful opportunity to comment upon a substantial adverse environmental effect of the plan or a feasible way to mitigate or avoid such an effect (including a feasible project alternative) that the plan's proponents have declined to implement. "Significant new information" requiring recirculation includes, for example, a disclosure showing that:

(1) A new significant environmental Impact would result from the plan or from a new mitigation measure proposed to be implemented.

(2) A substantial increase in the severity of an environmental Impact would result unless mitigation measures are adopted that reduce the Impact to a level of insignificance.

(3) A feasible project alternative or mitigation measure considerably different from others previously analyzed would clearly lessen the significant environmental Impacts of the plan, but the plan's proponents decline to adopt it.

(4) The plan was so fundamentally and basically inadequate and conclusory in nature that meaningful public review and comment were precluded.

Significant Sediment Discharge means soil erosion that is currently, or, as determined based upon visible physical conditions, may be in the future, discharged to Watercourses or lakes in quantities that violate Water Quality Requirements or result in significant individual or cumulative adverse Impacts to the beneficial uses of water. One indicator of a Significant Sediment Discharge is a visible increase in turbidity to receiving Class I, II, III, or IV waters.

Silviculture is the theory and practice of controlling the establishment, composition and growth of forests.

Silvicultural Methods in PRC Section 4582(d) is referred to as "silvicultural systems" for purposes of these regulations.

Silvicultural System is the planned program of forest stand treatments during the life of a stand. It consists of a number of integrated steps conducted in logical sequence leading to or maintaining a forest stand of distinctive form for the level of management intensity desired.

Site Classification, pursuant to PRC § 4528(d), means the classification of productive potential of Timberland into one of five classes by board regulation, consistent with normally accepted forestry practices.

CALIFORNIA FOREST PRACTICE RULES

Site I shall denote sites of highest productivity, site II and site III shall denote sites of intermediate productivity potential, and site IV and site V shall denote sites of lowest productivity potential.

Site Preparation means any activity involving mechanical disturbance of soils or burning of vegetation which is performed during or after completion of timber harvesting and is associated with preparation of any portion of a logging area for artificial or natural regeneration.

Site Preparation Addendum means an addendum to a THP which describes proposed Site Preparation areas, Site Preparation practices, and related measures.

Site Preparation Area means any portion of a logging area in which Site Preparation is conducted.

Site Survey Area means: the area where a field survey is conducted for archaeological and historical sites which includes the entire logging area except appurtenant roads and those portions of the 100 foot strip along such roads unless there are Timber Operations to remove commercial wood products that could affect an archaeological or historical site.

Skidding (see "Yarding" in this section).

Slash, pursuant to PRC § 4525.7, means branches or limbs less than four inches in diameter, and bark and split products debris left on the ground as a result of Timber Operations.

Slide Areas are areas indicated by the following characteristics:

1. **Shallow-seated Landslide.** An area where surface material (unconsolidated rock colluvium, and soil) has moved downslope along a relatively steep, shallow failure surface. The failure surface is generally greater than 65% in steepness and less than 5 feet in depth. It is usually characterized by: 1) a scarp at the top; 2) a concave scar below the scarp, where surface material has been removed; and sometimes 3) a convex area at the bottom where slide material is deposited. Vegetation is usually disturbed (tilted trees), anomalous (younger, evenaged stand), or absent (bare soil). Minor bank slumps are excluded from this definition.

2. **Deep-seated Landslide.** An area where landslide material has moved downslope either as relatively cohesive mass (rotational slides and translational block slides) or as an irregular, hummocky mass (earthflow). The failure surface is generally deeper than five feet and is usually well-exposed at the head scarp. Complex failures with rotational movement at the head and translational movement or earthflows downslope are common. Vegetation on rotational and transitional slides is relatively undisturbed, although trees and shrubs may be pistol-butted or tilted. Deep-seated landslides may have intermediate tension cracks, scarps, and shallow slides superimposed throughout the slide mass. Deep-seated landslide risk is usually associated with cohesive soils.

Small Group means groups of trees in areas up to 2½ acres.

Snag means a standing dead tree or a standing section thereof, regardless of species.

Southern Subdistrict of the Coast Forest District means the Timberlands in the Counties of Santa Cruz, Santa Clara, San Mateo, San Francisco and Marin situated within the boundaries of the Coast Forest District.

Special Treatment Areas are specific locations which contain one or more of the following significant resource features which may be at risk during Timber Operations:

- a. Within 200 feet of the Watercourse Transition Line of federal or state designated wild and scenic rivers;
- b. Within 200 feet of national, state, regional, county or municipal park boundaries;
- c. Key habitat areas of federal or state designated threatened, rare or endangered species;
- d. Coastal Commission Special Treatment Areas;
- e. Within 200 feet of state designated scenic highways or within scenic corridors established pursuant to Article 2.5 (commencing with Section 260) of Chapter 2 of Division 1 and Section 154 of Chap. 1 of Div. 1 of the Streets and Highways Code.

Species means a native species or subspecies of animal or plant in California.

Specific Forest means the area delineated under a Timber Management Plan.

Spotted Owl Expert means a person with at least a Bachelor of Science degree in Wildlife Biology, Biology, Forestry, Zoology or related field and a minimum of five field seasons of verifiable northern spotted owl survey and biological evaluation work. The SOE shall possess sufficient experience, knowledge and education in order to analyze data from field conditions and present written information which substantiates why harm and harassment of the northern spotted owl associated with Timber Operations will be avoided.

CALIFORNIA FOREST PRACTICE RULES

The individual shall be able to verify such experience, knowledge and education upon the Director's request. The Director shall refer all SOE qualifications received to the USFWS and CDFW for evaluation of qualifications.

Spotted Owl Resource Plan means a plan that demonstrates an approach to preventing a taking of the northern spotted owl while conducting Timber Operations. A Spotted Owl Resource Plan involves Timber Operations conducted under Notices of Timber Operations for an NTMP, Working Forest Harvest Notices under a WFMP, and/or more than one THP.

Stable Operating Surface means a road or Landing surface that can support vehicular traffic and has a structurally sound road base appropriate for the type, intensity and timing of intended use.

Stand Vigor is a measure of stand health. A measure of good stand vigor is an exhibition of characteristics which include large live crowns or leaf surface area, high needle retention, pointed tops, crown dominance relative to other trees in the same age or size class, and disease-free.

Stocking see PRC 4528(c).

Stocking Standards means the resource conservation standards established in 14 CCR 912.7 (932.7, 952.7) defining minimum acceptable stocking of an area with commercial tree species (Ref. 14 CCR 912 [932, 952]) after harvesting timber therefrom (Ref. Sec. 4561, PRC).

Stream see PRC 4528(f).

Stream Order means a classification method based on the branching pattern of Watercourses in a watershed. As Watercourses of equal order meet, they combine to form a Watercourse of the next higher order. A first order Watercourse is defined as the smallest unbranched Watercourse in the headwaters of a watershed (usually an ephemeral channel). When two first order Watercourse channels join, they form a second order Watercourse. Similarly, when two second order Watercourses join, they form a third order Watercourse (see Figure 2).

Figure 2: Plan view of Stream order delineation.

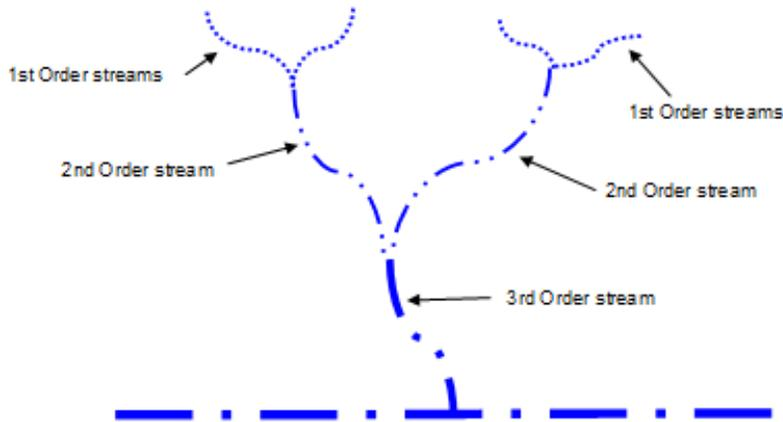

Substantial Adverse Change means demolition, destruction, relocation, or alteration such that the significance of an archaeological or historical site would be impaired.

Substantial Deviation means changes that are not "minor deviations" as defined in § 895.1 and are presumed to be substantial deviations because they could significantly affect the conduct of Timber Operations and potentially could have a significant adverse effect on timber productivity or values relating to soil, water quality, watershed, wildlife, fisheries, range and forage, recreation and aesthetic enjoyment. Such actions include, but are not limited to:

- (1) Change in location of timber harvesting operations or enlargement of the area to be cut.
- (2) Change in the silvicultural method and cutting system on any portion of the plan area.
- (3) Change in type or location of logging (Yarding) system or basic type of equipment.
- (4) Change in location, nature or increase in length of proposed Logging Roads

CALIFORNIA FOREST PRACTICE RULES

incorporating one or more of the following criteria:

(A) Any road in the Watercourse and Lake Protection Zone or where sidecast will extend into the Watercourse and Lake Protection Zone.

(B) Any road located in an extreme Erosion Hazard Rating area in the Coast or Northern Forest District, or a high Erosion Hazard Rating area in the Southern Forest District.

(C) Any road where the average side slope exceeds 50%.

(D) Any road where unstable areas, active soil movement, or slide areas must be traversed.

(E) Any increase in gradient allowed by the District Rules as an exception and not provided for in the original plan.

(F) Any road extension of more than 600 feet (182.9 m).

(5) Any use of existing roads not shown in the original plan when reconstruction work to allow for vehicle travel will be substantial. Substantial work on an existing road means more than minor repair and dressing of the travel surface and removal of vegetation to allow for vehicle passage.

(6) Use of any roads not shown in the plan which would affect the key habitat of rare or endangered species or other critical wildlife habitat.

(7) Enlargement of Landings where such enlargement was not justified in the original plan.

(8) Any change of operation in, or designation of, the Watercourse and Lake Protection Zone.

(9) Any downgrading of Stream classification.

(10) A change to winter operation where summer operations was previously specified.

Substantially Damaged Timberlands means areas of Timberland where wildfire, insects, disease, wind, flood, or other blight caused by an act of God occurs after January 1, 1976 and the damage reduced stocking below the requirements of PRC 4561 or other higher minimum stocking requirements that may be applicable under Articles 3 and 11 of Subchapter 4, Article 3 of Subchapter 5, and Articles 3 and 11 of Subchapter 6.

Supervised Designee means a person, who need not be an RPF, acting as an assistant under the supervision of an RPF pursuant to Article 3, Chapter 2, Division 1 of the Public Resources Code. For the purposes of this definition, "supervision" means the RPF must perform regular and timely quality control, work review and inspection, both in the office and in the field, and be able to take, or effectively recommend, corrective actions where necessary; the frequency of review, inspection and guidance shall take into consideration the experience of the non-RPF and technical complexity of the job, but shall be sufficiently frequent to ensure the accomplishment of work to professional standards.

Suppressed trees are those which have their crowns in the lower layers of the canopy. They receive virtually no direct sunlight, and they are generally growing very slowly.

Surface Cover means the cover of litter, downed woody material (including Slash, living vegetation in contact with the ground, and loose rocks (excluding rock outcrops) that resist erosion by raindrop impact and surface flow.

Surface Fuel means loose surface litter on the soil surface normally consisting of fallen leaves or needles, twigs, bark, cones and small branches that have not yet decayed enough to lose their identity.

Sustained Yield means the yield of commercial wood that an area of commercial Timberland can produce continuously at a given intensity of management consistent with required environmental protection and which is professionally planned to achieve over time a balance between growth and removal.

Take for Federally Listed Species means to harass, harm, pursue, hunt, shoot, wound, kill, trap, capture, or collect, or to attempt to engage in any such conduct as stated in 16 United States Code 1532(19).

Take for State Listed Species means to hunt, pursue, catch, capture, or kill, or attempting to do so, pursuant to Fish and Game Code Section 86.

Temporary Road means a Logging Road that is to be used only during Timber Operations and that will be deactivated or abandoned upon completion of use.

Tethered Operations means those Tractor Operations which utilize synchronized (here meaning a mode in which a traction aid winch is operated automatically with pre-set pulling and braking forces to maintain cable tension with the forward or reverse speed of the machine) cable winch systems which have been specifically designed or modified by the manufacturer or a Professional Engineer, as described within

CALIFORNIA FOREST PRACTICE RULES

the Professional Engineers Act (Chapter 7 of Division 3 of the Business and Professions Code), to assist equipment in felling or Yarding during Timber Operations.

Thalweg Riffle Crest means the upstream end of a riffle feature and can be identified as the area where the surface water flow changes from smooth to turbulent. The thalweg is found at the deepest part of the channel. Where the thalweg is measured in a pool, the riffle crest is a high point on a longitudinal profile and the shallowest place at the downstream end of a pool.

THP means Timber Harvesting Plan as described in PRC 4582.

Through Cut means a section of road that lies below the adjacent ground level on both sides of the road.

Tight-Lining means to move rigging from one tailblock location to another and tightening the main line to pull the cable to the new position.

Timberland, pursuant to PRC § 4526, means land, other than land owned by the federal government and land designated by the board as experimental forest land, which is available for, and capable of, growing a crop of trees of a commercial species used to produce lumber and other forest products, including Christmas trees. Commercial species, on a district basis, is defined in 14 CCR § 895.1.

Timber Falling Limitation the term used when special falling techniques and falling practices are required for the protection of water quality and beneficial uses, and/or other forest resources.

Timber Operations see PRC 4527.

Timber Operator, pursuant to PRC § 4526.5, means a person who is engaged in Timber Operations or who contracts with others to conduct the operations on his or her behalf, except a person who is engaged in Timber Operations as an employee with wages as his or her sole compensation.

Timber Owner see PRC 4527.5.

To Plan means examination of feasible alternatives, field review of alternatives, and reflection of this examination and field review in choice of road or Landing locations, and other factors, together with associated mitigation measures in the harvest plan.

Tractor Operations means any activity which is associated with Timber Operations and is performed by wheel or track mounted ground-based equipment, including, but not limited to, tractors or skidders.

Tractor Roads means constructed trails or established paths used by tractors or other vehicles for Skidding logs. Also known as "skid trails."

Tractor Yarding means that system of Skidding (transporting) logs by a self-propelled vehicle, generally by dragging the logs with a grapple or chokers.

Understory means, generally, trees and woody species growing under an overstory.

Unevenaged Management means management of a specific forest, with the goal of establishing a well stocked stand of various age classes and permits the periodic harvest of individual or small groups of trees to realize the yield and continually establish a new crop.

Unique Area means Special Treatment Areas defined in 14 CCR 895.1, 912, 932, and 952.

Unstable Areas are characterized by slide areas or unstable soils or by some or all of the following: hummocky topography consisting of rolling bumpy ground, frequent benches, and depressions; short irregular surface drainages begin and end on the slope; tension cracks and head wall scarps indicating slumping are visible; slopes are irregular and may be slightly concave in upper half and convex in lower half as a result of previous slope failure; there may be evidence of impaired ground water movement resulting in local zones of saturation within the soil mass which is indicated at the surface by sag ponds with standing water, springs, or patches of wet ground. Some or all of the following may be present: hydrophytic (wet site) vegetation prevalent; leaning, jackstrawed or split trees are common; pistol-butted trees with excessive sweep may occur in areas of hummocky topography (note: leaning and pistol butted trees should be used as indicators of slope failure only in the presence of other indicators).

Unstable Soils may be indicated by the following characteristics:

1. Unconsolidated, non-cohesive soils (coarser textured than Loam, as defined in Appendix I.A.1a of Board of Forestry Technical Rule Addendum No. 1, dated December 15, 1981) and colluvial debris including sands and gravels, rock fragments, or weathered granitics. Such soils are usually associated with a risk of shallow-seated landslides on slopes of 65% or more, having non-cohesive soils less than 5 ft. deep in an area where precipitation exceeds 4 in. in 24 hours in a 5-year recurrence interval.

2. Soils that increase and decrease in volume as moisture content changes. During dry

CALIFORNIA FOREST PRACTICE RULES

weather, these materials become hard and rock-like exhibiting a network of polygonal shrinkage cracks and a blocky structure resulting from desiccation. Some cracks may be greater than 5 feet in depth. These materials when wet are very sticky, dingy, shiny, and easily molded.

Utility Contact List means the list that identifies those utilities that must be notified pursuant to the Forest Practice Rules. The Department shall maintain this list utilizing information and advice provided by utilities. Each utility shall identify one (1) appropriate contact to be notified or consulted during preparation of review of THPs. The list shall be posted on the Department's internet site to make it readily available to RPFs and others needing the list to comply with these Rules. The list shall also be available by mail through written request to the appropriate CAL FIRE Review Team Offices. The utility shall be responsible for providing accurate contact information. Should an upgrade be required, each update will reflect a new revision date, so users of the list may identify which version of the list they are using.

Various Age Classes means a stand with at least three distinct layers of tree crowns (size classes).

Vegetation Protection the term used when special measures are required to prevent damage to vegetation for the protection of water quality, the beneficial uses of water, and/or other forest resources.

Water Quality Requirements means a water quality objective (narrative or numeric), prohibition, TMDL implementation plan, policy, or other requirement contained in a water quality control plan adopted by the Regional Board and approved by the State Water Board.

Waterbreak means a ditch, dike, or dip, or a combination thereof, constructed diagonally across Logging Roads, tractor roads and firebreaks so that water flow is effectively diverted therefrom. Waterbreaks are synonymous with waterbars.

Watercourse means any well-defined channel with distinguishable bed and bank showing evidence of having contained flowing water indicated by deposit of rock, sand, gravel, or soil, including but not limited to, Streams as defined in PRC 4528(f). Watercourse also includes manmade Watercourses.

Watercourse and Lake Protection Zone (WLPZ) means a strip of land, along both sides of a Watercourse or around the circumference of a lake or spring, where additional practices may be required for protection of the quality and beneficial uses of water, fish and Riparian wildlife habitat, other forest resources and for controlling erosion.

Watercourse Bank means the portion of the channel cross-section that confines the normal high water flow.

Watercourse Transition Line

Watercourse Transition Line, for a Watercourse without a CMZ, means the line defined by one or more the following features: 1) a change of vegetation from bare surfaces or annual water tolerant species to perennial water tolerant or upland species at least 25 years in age at breast height, 2) physical indicators of scour such as undercut banks, moss lines on rocks, the top of exposed roots along the channels, and 3) a change in the size distribution of surface sediments from gravel to fine sand. See Figures 3 and 3A.

Figure 3. Indicators for determining a Watercourse Transition Line.

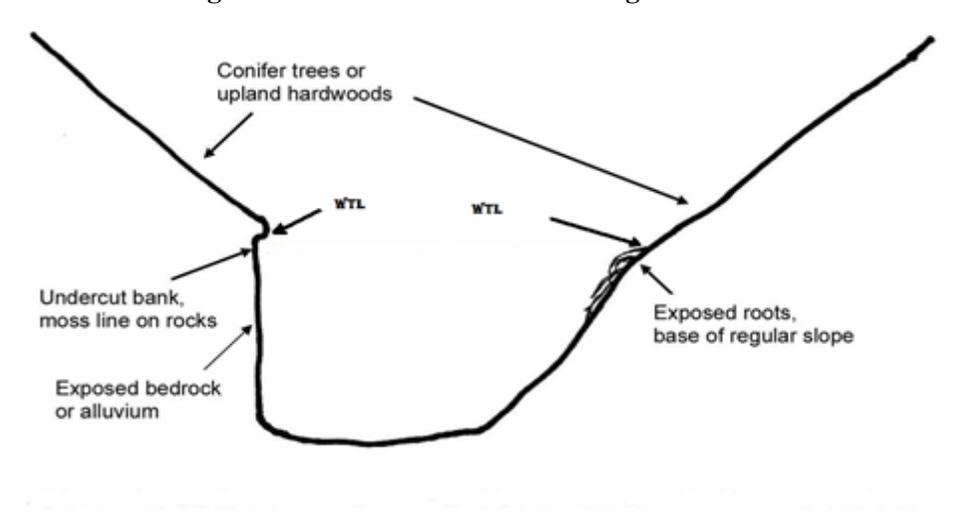

CALIFORNIA FOREST PRACTICE RULES

Figure 3A. Indicators for determining a Watercourse Transition.

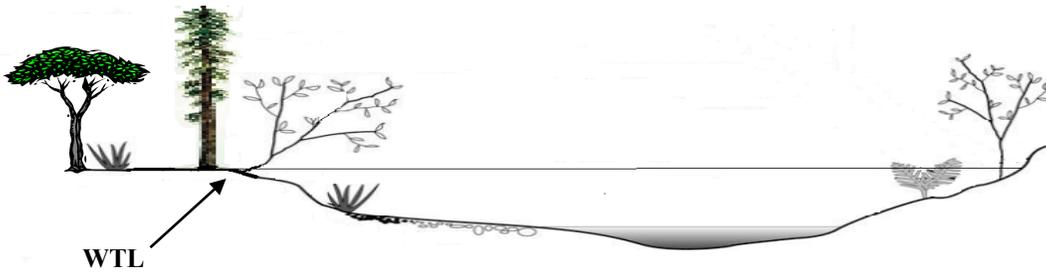

Watersheds in the Coastal Anadromy Zone means any planning watershed(s) in the Central California Coast coho salmon Evolutionarily Significant Units (ESUs), South Central Steelhead Distinct Population Segment (DPS), Central California Coast steelhead DPS, Northern California steelhead DPS, California Coastal Chinook salmon ESU, and Southern Oregon/Northern California Coast coho salmon ESU, as defined in 70 Federal Register 37160, dated June 28, 2005, where salmonids listed as threatened, endangered, or candidate under the State or Federal Endangered Species Acts are currently present or can be restored.

Watersheds with Coho Salmon means any planning watershed(s) where coho salmon (*Oncorhynchus kisutch*) have been documented by the Department of Fish and Game to be present during or after 1990. In Watersheds with Coho Salmon, the following definitions apply:

Road Maintenance means activities used to maintain and repair roads involving minor manipulation of the road prism to produce a stable operating surface and to ensure road drainage facilities, structures, cutbanks and fillslopes are kept in a condition to protect the road, minimize erosion, and to prevent sediment discharge into a Watercourse or lake. Examples of road maintenance include shaping and/or rocking a road surface; installation and maintenance of rolling and critical dips; restoring functional capacity of inboard ditches, cross drains, or culverts; and repairing water bars.

Road Prism means all parts of a road including cut banks, ditches, road surfaces, road shoulders, and road fills.

Stable Operating Surface means a road or Landing surface that can support vehicular traffic and that routes water off of the road surface or into drainage facilities without concentrating flow in ruts (tire tracks), pumping of the road bed, or ponding flow in depressions. A stable operating surface shall include a structurally sound road base appropriate for the intended use. The number, placement, and design of drainage facilities or drainage structures on a stable operating surface prevents the transport of fine-grained materials from the road or Landing surface into Watercourses in quantities deleterious to the beneficial uses of water.

Watersheds with Listed Anadromous Salmonids means any planning watershed where populations of anadromous salmonids that are listed as threatened, endangered, or candidate under the State or Federal Endangered Species Acts are currently present or can be restored. This definition does not apply to those portions of watersheds that are upstream of barriers, including large dams (where removal and/or fishway construction has been determined by NMFS and California Department of Fish and Wildlife to not be feasible) and natural barriers, such as long term bedrock falls or large static ancient slides with high-gradient or high-velocity barriers, that NMFS and California Department of Fish and Wildlife have determined are permanent and preclude anadromous fish passage.

Wet Meadows and Other Wet Areas means those natural areas which are moist on the surface throughout most of the year and support aquatic vegetation, grasses and forbs as their principal vegetative cover.

While Giving Consideration means the selection of those feasible silvicultural systems, operating methods and procedures which substantially lessen significant adverse Impact on the environment and which best achieve long-term, maximum sustained production of forest products, while protecting soil, air, fish and wildlife, and water resources from unreasonable degradation, and which evaluate and make allowance for values relating to range and forage resources, recreation and aesthetics, and regional economic vitality and

CALIFORNIA FOREST PRACTICE RULES

employment.

Winter Period means the period between November 15 to April 1, except as noted under special County Rules at 14 CCR, Article 13 § 925.1, 926.18, 927.1, and 965.5.

Woody debris means woody material four inches and greater in diameter and no less than two feet long left on the ground as the result of Timber Operations.

Yarding means the movement of forest products from the point of felling to a Landing.

CALIFORNIA FOREST PRACTICE RULES

SUBCHAPTER 2 APPLICATION OF FOREST PRACTICE RULES

Article 1 Introduction

896 General

(a) The purpose of the Forest Practice Rules is to implement the provisions of the Z'berg-Nejedly Forest Practice Act of 1973 in a manner consistent with other laws, including but not limited to, the Timberland Productivity Act of 1982, the California Environmental Quality Act (CEQA) of 1970, the Porter Cologne Water Quality Act, and the California Endangered Species Act. The provisions of these Rules shall be followed by Registered Professional Foresters (RPFs) in preparing Timber Harvesting Plans, and by the Director in reviewing such plans to achieve the policies described in Sections 4512, 4513, of the Act, 21000, 21001, and 21002 of the Public Resources Code (PRC), and Sections 51101, 51102 and 51115.1 of the Government Code.

It is the Board's intent that no THP shall be approved which fails to adopt feasible mitigation measures or alternatives from the range of measures set out or provided for in these Rules which would substantially lessen or avoid significant adverse Impacts which the activity may have on the environment. The THP process substitutes for the EIR process under CEQA because the timber harvesting regulatory program has been certified pursuant to PRC Section 21080.5. In recognition of that certification and PRC Section 4582.75, these Rules are intended to provide the exclusive criteria for reviewing THPs. If the Director believes that there are significant adverse environmental Impacts not covered in existing Rules, matters should be referred to the Board as otherwise specified in these Rules.

(b) The provisions of this subchapter shall be applied in all forest districts.

897 Implementation of Act Intent

(a) RPFs who prepare plans shall consider the range of feasible silvicultural system, operating methods and procedures provided in these Rules in seeking to avoid or substantially lessen significant adverse effects on the environment from timber harvesting. RPFs shall use these Rules for guidance as to which are the most appropriate feasible silvicultural systems, operating methods and procedures which will carry out the intent of the Act.

While giving consideration to measures proposed to reduce or avoid significant adverse Impacts of THPs on lands zoned TPZ, the RPF and Director shall include the following legal consideration regarding feasibility:

The Timberland Productivity Act restricts use of lands zoned Timberland Production Zone to growing and harvesting timber and compatible uses and establishes a presumption that timber harvesting is expected to and will occur on such lands.

(b) In determining whether a THP conforms to the intent of the Act, the Director shall be guided by the following principles:

(1) The goal of forest management on a specific ownership shall be the production or maintenance of forests which are healthy and naturally diverse, with a mixture of trees and under-story plants, in which trees are grown primarily for the production of high quality timber products and which meet the following objectives:

(A) Achieve a balance between growth and harvest over time consistent with the harvesting methods within the Rules of the Board.

(B) Maintain functional wildlife habitat in sufficient condition for continued use by the existing wildlife community within the planning watershed.

(C) Retain or recruit late and diverse seral stage habitat components for wildlife concentrated in the Watercourse and lake zones and as appropriate to provide for functional connectivity between habitats.

(D) Maintain growing stock, genetic diversity, and soil productivity.

(2) Individual THPs shall be considered in the context of the larger forest and planning watershed in which they are located, so that biological diversity and watershed integrity are maintained within larger planning units and adverse cumulative Impacts, including Impacts on the quality and beneficial uses of water are reduced.

CALIFORNIA FOREST PRACTICE RULES

(3) While the responsibility for implementation of the Act and Rules belongs to the Director and the Department, RPFs who prepare plans have the responsibility to provide the Director with information about the plan and resource areas and the nature and purpose of the operations proposed which is sufficiently clear and detailed to permit the Director to exercise the discretion and make the determinations required by the Act and Rules. The information in proposed plans shall also be sufficiently clear and detailed to permit adequate and effective review by responsible agencies and input by the public to assure that significant adverse individual and cumulative Impacts are avoided or reduced to insignificance.

(c) The Director shall use the standards provided in these Rules when reviewing plans to determine if they conform to the Rules and regulations of the Board and the provisions of the Act. In specific circumstances provided in these Rules, the Director shall disapprove plans because they conflict with the intent of the Act as interpreted by the Board.

(d) Due to the variety of individual circumstances of timber harvesting in California and the subsequent inability to adopt site-specific standards and regulations, these Rules use judgmental terms in describing the standards that will apply in certain situations. By necessity, the RPF shall exercise professional judgment in applying these judgmental terms and in determining which of a range of feasible (see definition 14 CCR 895.1) silvicultural systems, operating methods and procedures contained in the Rules shall be proposed in the plan to substantially lessen significant adverse Impacts in the environment from timber harvesting. The Director also shall exercise professional judgment in applying these judgmental terms in determining whether a particular plan complies with the Rules adopted by the Board and, accordingly, whether he or she should approve or disapprove a plan. The Director shall use these Rules to identify the nature of and the limits to the professional judgment to be exercised by him or her in administering these Rules.

(e) Based upon site-specific conditions where, in the judgment of the RPF, the application of Rules pertaining to how a timber operation will be conducted will not achieve the intent of the Act and Rules, and where the RPF can describe a practice(s) which will meet or exceed the intent of the Act and Rules, the RPF may prescribe an alternative practice(s) in lieu of those in the Rules. The practice(s) shall:

- (1)** be explained and justified by clear and convincing evidence in the plan;
- (2)** be written so they provide clear instructions and enforceable standards for the Timber Operator;
- (3)** provide a result(s) at least equal to that of the rule(s) to be supplanted; and
- (4)** provide that, where appropriate for the alternative practice, the plan submitter is responsible for retaining an RPF to aid in interpreting the THP to the Timber Operator and Timberland Owner on a continuing basis to help to assure compliance with the alternative.

(f) No alternative practice(s) as described in this section may be prescribed by an RPF or approved by the Director under this section in lieu of the following Rules:

(1) The Rules contained in Subchapter 2 (Application of Forest Practice Rules); Article 2 (Definitions, Ratings, and Standards) and Article 11 (Coastal Commission Special Treatment Areas) of Subchapter 4 (Coast Forest District Rules); Article 2 (Definitions, Ratings, and Standards) of Subchapter 5 (Northern Forest District Rules); Article 2 (Definitions, Ratings, and Standards) and Article 11 (Coastal Commission Special Treatment Areas) of Subchapter 6 (Southern Forest District Rules); and Subchapter 7 (Administration) of Chapter 4, Division 1.5 of the California Code of Regulations; or

(2) Any rule pertaining to the width of the Special Treatment Area adjacent to a wild and scenic river declared pursuant to PRC 5093.50, et seq.; or

(3) Any Rules or parts of Rules that incorporate practices or standards specified in the Forest Practice Act.

(g) No alternative practice as described in this section can be used in counties which have had Rules adopted under section 4516.5 of the Public Resources Code unless it is specifically adopted for the county.

(h) The Director shall not accept for inclusion in a THP any alternative practice as described in this section where two or more agencies listed in 4582.6 of the PRC and 14 CCR 1037.3 have submitted written comments which lead the Director to the conclusion that the proposed alternative will not meet the intent of the Act and Rules, and the agencies participated in the review of the plan, including any on-the-ground inspection.

CALIFORNIA FOREST PRACTICE RULES

Article 2 Preparation and Review of Timber Harvesting Plans

898 Feasibility Alternatives

After considering the Rules of the Board and any mitigation measures proposed in the plan, the RPF shall indicate whether the operation would have any significant adverse Impact on the environment. On TPZ lands, the harvesting per se of trees shall not be presumed to have a significant adverse Impact on the environment. If the RPF indicates that significant adverse Impacts will occur, the RPF shall explain in the plan why any alternatives or additional mitigation measures that would significantly reduce the Impact are not feasible.

Cumulative Impacts shall be assessed based upon the methodology described in Board Technical Rule Addendum Number 2, Forest Practice Cumulative Impacts Assessment Process and shall be guided by standards of practicality and reasonableness. The RPF's and plan submitter's duties under this section shall be limited to closely related past, present and Reasonably Foreseeable Probable Future Projects within the same ownership and to matters of public record. The Director shall supplement the information provided by the RPF and the plan submitter when necessary to ensure that all relevant information is considered.

When assessing cumulative Impacts of a proposed project on any portion of a waterbody that is located within or downstream of the proposed timber operation and that is listed as water quality limited under Section 303(d) of the Federal Clean Water Act, the RPF shall assess the degree to which the proposed operations would result in Impacts that may combine with existing listed stressors to impair a waterbody's beneficial uses, thereby causing a significant adverse effect on the environment. The plan preparer shall provide feasible mitigation measures to reduce any such Impacts from the plan to a level of insignificance, and may provide measures, insofar as feasible, to help attain water quality standards in the listed portion of the waterbody.

The Director's evaluation of such Impacts and mitigation measures will be done in consultation with the appropriate RWQCB.

898.1 Review of Plan by Director

The Director shall review plans to determine if they are in conformance with the provisions of PRC 4582.75 which requires that Rules adopted by the Board shall be the only criteria employed by the Director in reviewing plans pursuant to PRC 4582.7.

(a) In reviewing plans, the Director shall apply all applicable Rules promulgated by the Board.

(b) When in doubt as to the feasible alternative which best carries out the intent of the Act, the Director shall seek the advice of other state agencies charged with protecting the public interest in forest-related resources.

(c) In reviewing plans, the Director shall disapprove all plans which:

(1) Do not incorporate feasible silvicultural systems, operating methods and procedures that will substantially lessen significant adverse Impacts on the environment.

(2) Would not meet the requirements of individual Rules which provide a range of feasible alternatives through which to carry out the intent of the Act.

(3) Meet the special conditions for disapproval set by the Board in 14 CCR 898.2.

(d) In reviewing plans, if the Director, finds that a plan cannot be approved without a change in the conduct of Timber Operations, the Director shall, consistent with the Rules and procedures adopted by the Board, communicate with the preparer of the plan, explain any probable causes for disapproval and suggest possible mitigation measures. The preparer of the plan shall then have the opportunity to respond to the Director and provide appropriate mitigation measures prior to the end of the public comment period.

(e) If the Director disapproves a plan, the Director shall, consistent with the Rules and procedures adopted by the Board, provide to the preparer of the plan written reasons for disapproval.

(f) If the Director finds no feasible, less-damaging alternatives that conform with the Rules, the Director shall approve such plan unless approval threatens to cause immediate, significant, and long-term harm to the natural resources of the state. In the event of such a threat, the Director shall withhold decision on the plan and shall follow procedures developed by the Board pursuant to PRC 4555.

(g) If the Director determines that:

1) all feasible mitigation measures or alternatives which are available to substantially reduce or

CALIFORNIA FOREST PRACTICE RULES

avoid any significant adverse Impacts of a THP have been selected;

- 2) significant adverse Impacts remain;
- 3) the plan otherwise complies with the Rules of the Board; and

4) an emergency situation does not exist under PRC Section 4555, the Director shall not approve the plan unless the Director also determines that the benefits of the THP outweigh any significant, unavoidable adverse Impacts. If the Director makes such a determination and approves the THP, the Notice of Conformance shall include an explanation of the basis for finding that the conditions 1-3 herein are met and for determining that the THP's benefits outweigh any unavoidable significant adverse Impacts.

In making such a determination for THPs on lands zoned TPZ the Director shall give consideration to the Legislature's objectives in enacting the Timberland Productivity Act of 1982 ("TPA") and the objectives of the FPA including sustained forest productivity. The TPA-associated benefits to be weighed against any significant avoidable adverse Impacts shall include, but not be limited to:

(1) Ensuring consistency with the restriction of the use of TPZ lands to growing and harvesting timber and compatible uses;

(2) Making cumulative progress toward:

(a) realizing the productive potential of the forest resources of the state and

(b) providing a favorable climate for long-term investment in forest resources, thereby discouraging the premature and unnecessary conversion of Timberland to urban and other uses; and

(3) Ensuring consistency with the Legislature's declaration that Timber Operations may reasonably be expected to and will occur on lands zoned TPZ.

(h) In determining whether the public benefits of the THP outweigh any unavoidable significant adverse Impacts pursuant to (g) above, the Director may request information as needed to evaluate potential job loss, negative economic Impacts on the community, business closings, loss of property by owners, probable conversion to other uses, estate taxes and other factors as appropriate.

898.2 Special Conditions Requiring Disapproval of Plans

The Director shall disapprove a plan as not conforming to the Rules of the Board if any one of the following conditions exist:

(a) Boundaries of the area to be harvested are not clearly delineated in the plan.

(b) Public acquisition of the parcel for purposes which would be impaired by timber harvesting, is legislatively authorized, funded and imminent.

(c) There is evidence that the information contained in the plan is incorrect, incomplete or misleading in a material way, or is insufficient to evaluate significant environmental effects. The sufficiency of the information provided in a THP to evaluate significant environmental effects shall be judged in light of what is reasonable and necessary.

(d) Implementation of the plan as proposed would result in either a "taking" or finding of jeopardy of wildlife species listed as rare, threatened or endangered by the Fish and Game Commission, the National Marine Fisheries Service, or Fish and Wildlife Service, or would cause significant, long-term damage to listed species. The Director is not required to disapprove a plan under either of the following circumstances:

(1) Which would result in a "taking" if the "taking" is incidental and is authorized by a wildlife agency acting within its authority under state or federal endangered species acts.

(2) Where anadromous salmonid populations are designated as an experimental population under Section 10(j) of the federal Endangered Species Act, and corresponding regulations under Section 4(d) of the federal Endangered Species Act for those populations provide an exception from take prohibitions under the federal Endangered Species Act for activities subject to the California Forest Practice Rules, and federal and state agencies determine no further take authorizations are necessary, under the federal Endangered Species Act or the California Endangered Species Act.

(e) Implementation of the plan would irreparably damage plant species listed as rare or endangered by the CDFW and when the Timber Owner fails to comply with F&GC 1913.

(f) Implementation of the plan as proposed would result in the taking of an individual Northern Spotted Owl prohibited by the Federal Endangered Species Act.

(g) Implementation of the plan as proposed would not achieve maximum sustained production of high quality timber products as provided for by the Rules of the Board, and by the intent of the Act.

CALIFORNIA FOREST PRACTICE RULES

(h) Implementation of the plan as proposed would cause a violation of any requirement of an applicable water quality control plan adopted or approved by the State Water Resources Control Board.

(i) Implementation of the plan as proposed would result in significant adverse slope stability Impacts that could affect public safety. The Director's determination of this special condition shall be supported by a review from the California Geological Survey.

Article 3 PRC § 4555, Rule Review Procedures

900 Intent

Regulations set forth in this article are adopted pursuant to Legislative direction set forth in PRC 4552 and 4555 and to provide a hearing procedure as mandated in PRC 4555.

901 Timber Harvesting Plan Decision Delay

The Director shall delay making a decision to approve or disapprove a plan which has been filed only if he or she finds that it could result in immediate, significant and long-term harm to the natural resources of the state. In relation to ascertaining harm to the natural resources of the state, the words immediate, significant and long-term shall be construed to mean:

(a) "Immediate"- a period of time from the present to some future date that shall not be later than the end of the third timber harvest season following commencement of Timber Operations under a proposed plan.

(b) "Significant"- harm or damage which is substantial and threatens the use of forest-related benefits (i.e., other beneficial uses of the air, water, soil, fish or wildlife resources).

(c) "Long-term"- harm or damage that is of such a nature and of lasting duration which cannot be corrected within 3 timber harvest seasons following commencement of Timber Operations under a proposed plan.

902 Director's Notice to Board

If the Director determines that a substantial question concerning the intent of the Act is not currently provided for by the Rules of the Board, and that approval of a plan which has been filed could result in immediate, significant and long-term harm to the natural resources of the State, the Director shall within 5 days after making such determination, notify the Board and the person who submitted the plan in writing of his or her determination. Written notice to the Board shall:

(a) State that the Director is seeking an emergency determination by the Board pursuant to PRC 4555.

(b) Outline the substantial question concerning intent of the Act that is not currently provided for by the Rules.

(c) Identify any particular rule or Rules which may be in question with respect to the intent of the Act.

(d) Identify any other provisions of law which apply to the Director's decision to delay.

902.1 Board Action

Within 30 days after receipt of written notice from the Director that he or she had delayed making a decision to approve or disapprove a plan pursuant to PRC 4555, and 14 CCR 901, the Board will hold a public hearing on the issue raised by the Director in said notice. Thereafter the Board may adopt emergency regulations in the manner provided by the Administrative Procedure Act (commencing with Gov. C. 11420) and shall conform to specifications enumerated in 14 CCR 902.2, 902.3, 903 and 903.1.

902.2 Notice Content

The Notice of Public Hearing on issues raised pursuant to provisions of PRC 4555 shall contain substantially the same information as provided to the Board pursuant to 14 CCR 902.

902.3 Notice Distribution

Notice of public hearing on issues raised by the Director pursuant to provisions of PRC 4555 shall be given at least 15 days prior to said hearing and be distributed as follows by:

(a) Mailing such notice to concerned federal, state and local agencies of government;

(b) Providing for mailing to Timber Owners, operators, and foresters (RPFs), who have plans held in abeyance by the Director pending action by the Board under PRC 4555.

CALIFORNIA FOREST PRACTICE RULES

(c) Providing for dissemination to the agenda mailing list of the Board and other parties as may be determined to be appropriate by the Executive Officer to provide full public participation in the hearing.

903.1 Content of Discussion and Prejudice of Appeal

In considering the need for possible emergency regulations, as well as the emergency regulations themselves, the Board normally will consider all relevant information. However, to avoid prejudicing future appeals on individual plans, the proceeding shall be addressed solely to the generic issue(s) presented by the Director.

903.2 Board Action

Immediately after public comments the Board shall determine whether or not the intent of the Act has been provided for in the Rules effective at the time the Director's determination was made. If the Board finds the existing Rules are adequate, it shall adopt a finding so stating.

If the Board finds that the intent of the Act has not been provided for in such Rules, the Board shall comply with the provisions of PRC 4555 and immediately amend the Rules to provide for such intent by adopting emergency regulations pursuant to the Administrative Procedure Act (commencing with Gov. C. 11371). The Board shall advise the Director by letter of the action taken and provide a copy of the emergency regulations indicating that they will become effective upon filing with the Secretary of State.

In either case, the Director shall act within 5 days after receipt of said letter on plans being held in abeyance pending Board consideration.

SUBCHAPTER 3 FOREST DISTRICT BOUNDARIES

Article 1 Districts

906 Forest Districts

To meet the requirements of Chapter 8, Article 3 (commencing with Section 4531), Public Resources Code, and to designate areas for appropriate special forest practice Rules, the nonfederally-owned commercial forest areas of the state are divided into three districts which are designated as Coast Forest District, Northern Forest District, and Southern Forest District. Each district is comprised of Timberlands within the boundaries as set forth in this article.

907 Coast Forest District

The Coast Forest District is comprised of the area bounded on the north by the State of Oregon, on the west by the Pacific Ocean, and on the south and east by a line declared and fixed as follows:

Beginning at the southwest corner of Santa Cruz County and running eastward along the southern boundaries of Santa Cruz and Santa Clara Counties to U.S. Highway 101; thence northerly along U.S. Highway 101 to Interstate Highway 680; thence northerly along Interstate Highway 680 to Interstate Highway 80; thence southerly along Interstate Highway 80 to State Highway 29 between Vallejo and the Carquinez Bridge; thence northerly along State Highway 29 to State Highway 128 at Rutherford; thence northerly along coinciding State Highways 29 and 128 to the junction of State Highways 29 and 128 at Calistoga; thence northwesterly along State Highway 128 to U.S. Highway 101; thence northerly along U.S. Highway 101 to the Covelo Road (State Highway 162, formerly designated 261); thence northeasterly along the Covelo Road to Mina Road (Mendocino County Road 336) just north of Covelo; thence northerly from Mendocino County into Trinity County along Mina Road, where it continues as Lake Mountain Road (Trinity County Road 503); continuing along Lake Mountain Road northwesterly through Kettenspom to the Ruth-Zenia Road (Trinity County Road 502) just southeast of Zenia, thence easterly and northerly along the Ruth-Zenia Road to the Van Duzen Road (Trinity County Road 511) at the Van Duzen River on the northwest side of Hettenshaw Valley; thence along the Van Duzen Road, following along a fork of the Van Duzen River and the main Van Duzen River northwesterly and northerly to State Highway 36, thence southeasterly along State Highway 36 to the South Fork of the Trinity River, thence northerly along the South Fork of the Trinity River and the main Trinity River to the Klamath River, thence northeasterly, then northerly along the Klamath River to the mouth of Indian Creek; thence northerly along Indian Creek to the

CALIFORNIA FOREST PRACTICE RULES

crossing of State Highway 96; thence northeasterly along State Highway 96 to the Indian Creek Road (Siskiyou County Road 7C01); thence northwesterly along the Indian Creek Road following along Indian Creek to the crossing of Indian Creek in the south half of Section 25, Township 18N, Range 6E, HB&M, from whence the Indian Creek County Road continues as the U.S. Forest Service Grayback Road (U.S. Forest Service Road 40S07); continuing northwesterly along the Forest Service Grayback Road over the divide at the head of Indian Creek to the State of Oregon in Section 32, Township 19N, Range 6E, HB&M.

908 Northern Forest District

The Northern Forest District is comprised of the area bounded on the north by the State of Oregon, on the east by the State of Nevada, on the west by the Coast Forest District, and on the south by a line declared and fixed as follows:

Beginning at the point where Interstate Highway 680 crosses the combined San Joaquin-Sacramento Rivers at the Benicia Bridge; thence easterly along the channel to the mouth of the Sacramento River; thence easterly and northerly along the Sacramento River to the Sacramento-Sutter County line; thence easterly along said county line to the Sacramento-Placer County line; thence easterly along said county line to the Placer-EI Dorado County line; thence northerly and easterly along said county line to the intersection with the Lake Tahoe Basin crestline; thence northerly and then easterly along said crestline to its intersection with the west boundary of Section 10; thence north along the west boundary of Section 10 and Section 3 to the northwest corner of Section 3; thence east along the north boundary of Section 3 and Section 2 to the Lake Tahoe Basin crestline, all Sections being in Township 15N, Range 16E, MDB&M; thence northerly and easterly along said crestline to the State of Nevada.

909 Southern Forest District

The Southern Forest District is comprised of the area bounded on the north by the Northern Forest District, on the west by the Coast Forest District and the Pacific Ocean south of Santa Cruz County, on the east by the States of Nevada and Arizona, and on the south by Mexico.

909.1 High Use Subdistrict

The "High Use Subdistrict" of the Southern Forest District includes the Counties of Ventura, Santa Barbara, Los Angeles, San Bernardino, Orange, Riverside, Imperial, San Diego, Monterey, San Luis Obispo, and those portions of Placer and El Dorado lying within the authority of the Tahoe Regional Planning Agency. In this subdistrict, the growing of commercial timber is subjected to pressures for competing land uses, such as recreation, water, and urbanization.

SUBCHAPTERS 4, 5 & 6 FOREST DISTRICT RULES

Article 1 Introduction

911, 931, 951 Statement of Purpose [All Districts]

The purpose of these Rules is to establish district forest practice Rules and to establish standards in accordance with the policies set forth in Articles 1 and 4 of the Z'berg-Nejedly FPA of 1973 (Sections 4511-4517 and 4551-4555 incl. of the PRC). Rules promulgated herein apply only to Timberlands.

Article 2 Ratings and Standards

912.5 Procedure for Estimating Surface Soil Erosion Hazard Rating [Coast]

A proposed plan shall show the estimated erosion hazard ratings of the plan area, by areas, down to 20 acres (8.1 ha) if such a breakdown will change the estimated erosion hazard of individual areas. The plan shall show high and extreme erosion hazard ratings, by areas, down to 10 acres if such a breakdown will change the erosion hazard of the individual areas. Specific erosion hazard areas not fitting the above minimum will be considered independently and protective measures commensurate with the problem applied. These measures are covered in Chapter 4, Subchapter 4 of Title 14, CCR.

To estimate the erosion hazard rating of any plan or portion thereof, the RPF or supervised designee shall follow the procedures and requirements contained in Board Technical Rule Addendum #1, dated February 1,

CALIFORNIA FOREST PRACTICE RULES

1990. Appropriate weights for the factors in the Estimated Surface Soil Erosion Hazard, Form I, in the Addendum, shall be calculated and the factors shall be summed to give the rating. A copy of the calculations from Form I shall be attached to the timber harvesting plan. A copy of the Board Technical Rule Addendum #1 can be obtained from the State Board of Forestry and Fire Protection at the State of California Resources Building, 715 P Street Sacramento, CA 95814, or P.O. Box 944246, Sacramento, CA 94244-2460.

932.5, 952.5 Procedure for Estimating Surface Soil Erosion Hazard Rating [Northern, Southern]

A proposed plan shall show the estimated erosion hazard ratings of the plan area, by areas, down to 20 acres (8.1 ha) if such a breakdown will change the estimated erosion hazard of individual areas.

To estimate the erosion hazard rating of any plan or portion thereof, the RPF or supervised designee shall follow the procedures and requirements contained in Board Technical Rule Addendum #1, dated February 1st, 1990. Appropriate weights for the factors in the Estimated Surface Soil Erosion Hazard, Form I, in the Addendum shall be calculated and the factors shall be summed to give the rating. A copy of the calculations from Form I shall be attached to the timber harvesting plan. A copy of the Board Technical Rule Addendum #1 can be obtained from the State Board of Forestry and Fire Protection at the Resources Building, 715 P Street, Sacramento, CA 95814, or P.O. Box 944246, Sacramento, CA 94244-2460.

912.7, 932.7, 952.7 Resource Conservation Standards for Minimum Stocking [All Districts, Note variation by District in (b)(1), (b)(1)(C), (b)(1)(D)]

The following resource conservation standards constitute minimum acceptable stocking in the Coast [Northern, Southern] Forest District after Timber Operations have been completed.

(a) Rock outcroppings, Meadows and Wet Areas, or other areas not normally bearing commercial species shall not be considered as requiring stocking and are exempt from such provisions.

(b) An area on which Timber Operations have taken place shall be classified as acceptably stocked if either of the standards set forth in (1) or (2) below are met within five (5) years after completion of Timber Operations unless otherwise specified in the Rules.

(1) [Coast] An area contains an average point count of two hundred (200) per acre on Site I and II lands, one hundred twenty-five (125) on Site III lands, or one hundred (100) on site IV and V lands. The point count to be computed as follows:

(A) Each countable tree [Ref. PRC § 4528(b)] which is not more than four (4) inches d.b.h. counts one (1) point.

(B) Each countable tree over four (4) inches and not more than twelve (12) inches d.b.h. counts two (2) points.

(C) Each countable tree over twelve (12) inches d.b.h. counts as four (4) points.

(D) Root crown sprouts will be counted using the average stump diameter twelve (12) inches above average ground level of the original stump from which the sprouts originate, counting one sprout for each foot of stump diameter to a maximum of six (6) per stump.

(1) [Northern, Southern] An area contains an average point count of one hundred twenty-five (125) per acre on Site I, II and III lands or one hundred (100) on Site IV and V lands, to be computed as follows:

(A) Each countable tree [Ref. PRC § 4528(b)] which is not more than four (4) inches d.b.h. counts one (1) point.

(B) Each countable tree over four (4) inches and not more than twelve (12) inches d.b.h. counts two (2) points.

(C) [Northern, Southern] Each countable tree over twelve (12) inches d.b.h. counts three (3) points.

(D) [Northern] Sprouts over one (1) foot in height will be counted, counting one (1) sprout for each six (6) inches or part thereof of stump diameter to a maximum of four (4) per stump.

(D) [Southern] Root crown sprouts over one (1) foot in height will be counted, using the average stump diameter at one (1) foot above the average ground level of the original stump, counting one (1) sprout for each foot of stump diameter to a maximum of six (6) per stump.

(2) The average residual basal area measured in stems one (1) inch or larger in diameter, is at least eighty-five (85) square ft. per acre on Site I lands, and fifty (50) square ft. per acre on lands of Site II classification or lower. Site classification shall be determined by the RPF who prepared the plan.

CALIFORNIA FOREST PRACTICE RULES

(3) To the extent basal area standards are specified in the Rules in excess of 14 CCR § 912.7(b)(2) [932.7(b)(2), 952.7(b)(2)], up to fifteen (15) square feet of basal area of those standards higher than the minimum may be met by counting snags, and decadent or deformed trees of value to wildlife. The minimum size shall be twenty (20) inches or greater d.b.h. and twenty (20) feet or greater in height.

(c) The substitution provided for in 14 CCR § 912.7(b)(3) [932.7(b)(2), 952.7(b)(2)] may only be done when the potential spread of insects and diseases will not have a significantly adverse Impact on long term productivity or forest health.

(d) The resource conservation standards of the Rules may be met with Group A and/or B commercial species. The percentage of the stocking requirements met with Group A species shall be no less than the percentage of the stand basal area they comprised before harvesting. The site occupancy provided by Group A species shall not be reduced relative to Group B species. When considering site occupancy, the Director shall consider the potential long term effects of relative site occupancy of Group A species versus Group B species as a result of harvest. If Group A species will likely recapture the site after harvest, Group B species do not need to be reduced. The time frames for recapturing the site shall be consistent with achieving MSP. The Director may prohibit the use of Group A and/or B commercial species which are non-indigenous or are not physiologically suited to the area involved. Exceptions may be approved by the Director if the THP provides the following information and those exceptions are agreed to by the Timberland Owner:

(1) Explain and justify with clear and convincing evidence how using Group A nonindigenous, or Group B species to meet the resource conservation standards will meet the intent of the Forest Practice Act as described in PRC § 4513. The discussion shall include at least:

(A) The management objectives of the post-harvest stand;

(B) A description of the current stand, including species composition and current stocking levels within the area of Group B species. The percentage can be measured by using point-count, basal area, stocked plot, or other method agreed to by the Director.

(C) The percentage of the post-harvest stocking to be met with Group B species. Post-harvest percentages will be determined on the basis of stocked plots. Only the methods provided by 14 CCR §§ 1070-1075 shall be used in determining if the standards of PRC § 4561 have been met.

(D) A description of what will constitute a countable tree, as defined by PRC § 4528 for a Group B species and how such a tree will meet the management objectives of the post-harvest stand.

The Director, after an initial inspection pursuant to PRC § 4604, shall approve use of Group B species, as exceptions to the pre-harvest basal area percentage standard, if in his judgment the intent of the Act will be met, and there will not be an immediate significant and long-term harm to the natural resources of the state.

(e) An RPF may propose an alternative stocking standard for any proposed regeneration method, intermediate treatment or special prescription.

(1) The proposed alternative shall not fall below resource conservation standards for minimum stocking described above. The proposed alternative stocking shall contribute to one (1) or more of the following forest health and ecological goals:

(A) Improved fire resilience; or

(B) Increased drought tolerance; or

(C) Improved forest pest and disease resistance; or

(D) Increased carbon sequestration rates and climate benefits related to forests and durable wood products; or

(E) Appropriate stocking for resilient forests in a changing climate; or

(F) Avoidance of large-scale disturbances which promote homogeneity in forests.

(2) The RPF shall describe the management objective for the stand, state the alternative stocking standard for the proposed regeneration method, intermediate treatment or special prescription and explain and justify the proposed alternative stocking standard by providing the following information:

(A) Site specific characteristics including site class, aspect, soil type, elevation, slope, understory shrub composition, and a general discussion of available water in the soil.

(B) Economic factors supporting the proposed alternative and associated risks if the alternative stocking is not implemented.

(C) A description of the current Harvest Area, including species composition and current Stocking measured using the applicable basal area method.

CALIFORNIA FOREST PRACTICE RULES

(D) A discussion of the projected post-harvest species composition and Stocking using the same measure of Stocking used for the description of the current stand.

(E) A discussion of how the proposed alternative stocking will contribute to the Board's forest health and ecological goals of 14 CCR § 912.7 [932.7, 952.7] (e)(1)(A)-(F).

(F) A description of stand maintenance and vegetation treatments that will be applied where necessary to ensure suitable resource conservation and site occupancy post-harvest.

(3) The proposed alternative stocking area shall be inspected on site by the Director. A sample Mark may be required based upon the type of harvest. The Director will verify on-site conditions and certify that the proposed alternative Stocking will contribute to one or more of the forest health and ecological goals identified in 14 CCR § 912.7 [932.7, 952.7] (e)(1)(A)-(F). The Director may approve the proposed alternative if the intent of the Act and the Rules will be met, and there will not be immediate or long-term significant harm to the natural resources of the state.

912.8 Progeny, Clonal, or Provenance Testing Stocking Standard Exemption [Coast only]

Pursuant to PRC 4561.7, the following standards shall apply to the request for an exemption from the stocking standards of the Act for Progeny, clonal, or provenance testing.

(a) Any THP submitted pursuant to Sec. 4561.7 of the PRC shall include the following information, in addition to other requirements of the Rules of the Board:

(1) A specific request for an exemption from stocking standards; and

(2) A description of the testing to be conducted on the site.

(b) The exemption from stocking shall become effective upon the Director's determination that the timber harvesting plan is in conformance with the Rules and regulations of the Board.

CALIFORNIA FOREST PRACTICE RULES

912.9, 932.9, 952.9 Cumulative Impacts Assessment Checklist [All Districts]

**STATE OF CALIFORNIA BOARD OF FORESTRY AND FIRE PROTECTION
CUMULATIVE IMPACTS ASSESSMENT**

- (a)** Do the assessment area(s) of resources that may be affected by the proposed Project contain any Past Projects, or Reasonably Foreseeable Probable Future Projects? Yes ___ No ___
If the answer is yes, identify the project(s) and affected resource subject(s).
- (b)** Are there any continuing, significant adverse Impacts from past land use activities that may add to the Impacts of the proposed Project? Yes ___ No ___ If the answer is yes, identify the activities, describing their location, Impacts and affected resource subject(s).
- (c)** Will the proposed Project, as presented, in combination with Projects, and Reasonably Foreseeable Probable Future Projects identified in items (a) and (b) above, have a reasonable potential to cause or add to significant adverse Cumulative Impacts in any of the following resource subjects?

Resource Subjects	Yes after mitigation (1)	No after mitigation (2)	No reasonably potential significant adverse Impacts (3)
(A) Watershed			
(B) Soil Productivity			
(C) Biological			
(D) Recreation			
(E) Visual			
(F) Traffic			
(G) Greenhouse Gases (GHG)			
(H) Wildfire Risk and Hazard			
(I) Other			

1) "Yes, after mitigation" means that potential significant adverse Cumulative Impacts are left after application of the Rules and mitigations or alternatives proposed by the Plan Submitter.

2) "No after mitigation" means that any potential for the proposed Timber Operation to cause or add to significant adverse Cumulative Impacts by itself or in combination with other Projects has been reduced to insignificance or avoided by mitigation measures or alternatives proposed in the Plan and application of the Rules.

3) "No reasonably potential significant adverse Impacts" means that the operations proposed under the Plan and application of the Rules do not have a reasonable potential to join with the Impacts of any other Project to cause, add to, or constitute significant adverse cumulative Impacts.

NOTE: Guidance on evaluating Impacts to resource subjects are provided within the Appendix to Technical Rule Addendum No. 2.

CALIFORNIA FOREST PRACTICE RULES

(d) If column (1) is checked in (c) above describe why the expected Impacts cannot be feasibly mitigated or avoided and what mitigation measures or alternatives were considered to reach this determination. If column (2) is checked in (c) above describe what mitigation measures or alternatives have been selected which will substantially reduce or avoid reasonably potential significant adverse Cumulative Impacts.

(e) Provide a brief description of the assessment area used for each resource subject.

(f) List and briefly describe the individuals, organizations, and records consulted in the assessment of Cumulative Impacts for each resource subject. Records of the information used in the assessment shall be provided to the Director upon request.

BOARD OF FORESTRY AND FIRE PROTECTION TECHNICAL RULE ADDENDUM NO. 2 CUMULATIVE IMPACTS ASSESSMENT

A. Introduction

The purpose of this addendum is to provide a framework for the assessment of Cumulative Impacts as required in 14 CCR § 898 that may occur as a result of proposed Timber Operations. Cumulative Impacts, pursuant to 14 CCR § 15355, refers to two or more individual Effects which, when considered together, are considerable or which compound or increase other environmental Impacts. This assessment shall include evaluation of both on-site and off-site interactions of proposed project activities with the Impacts of Past Projects and Reasonably Foreseeable Probable Future Projects.

Resource subjects to be considered in the assessment of Cumulative Impacts are listed in 14 CCR § 912.9(c) and described in greater detail in the Appendix to this Addendum.

In conducting an assessment, the RPF must distinguish between the potential on-site Impacts of the Plan's proposed activities (which may not be significant when considered alone) with Impacts of Timber Operations and Reasonably Foreseeable Future Projects pursuant to 14 CCR § 15130(b)(1)(A).

The RPF preparing a THP shall conduct an assessment based on information that is reasonably available before submission of the Plan. RPFs shall submit sufficient information to support their findings if significant issues are raised during the Department's review of the Plan.

Information used in the assessment of Cumulative Impacts may be supplemented during the Plan review period. Agencies participating in Plan review may provide input into the Cumulative Impacts assessment based upon their area of expertise. Agencies shall justify and support their recommendations with documentation.

The Department, as lead agency, shall make the final determination regarding assessment sufficiency and the presence or absence of significant adverse Cumulative Impacts. This determination shall be based on a review of all sources of information provided and developed during review of the Plan.

B. Identification of Assessment Areas

The RPF shall establish and briefly describe the assessment area within or surrounding the Plan for each resource subject and shall briefly explain the rationale for establishing the resource area. This shall be a narrative description and each established assessment area shall be shown on a map when a map adds clarity.

C. Identification of Information Sources

The RPF who prepares the Plan shall obtain information from Plan submitters (Timberland or Timber Owner), appropriate agencies, landowners, and individuals about past, and future land management activities. The RPF shall list and briefly describe the individuals, organizations, and records relied upon as sources of information in the assessment of Cumulative Impacts, including references for listed records and the names, affiliations, and contact information of specific individuals contacted. Records of information used in the assessment shall be provided to the Director upon request.

Common sources of information for the assessment of Cumulative Impacts assessment are identified below. Sources to be used will depend upon the complexity of individual situations and the amount of

CALIFORNIA FOREST PRACTICE RULES

information available from other plans. Sources not listed below may have to be consulted based on individual circumstances. Not all sources of information need to be consulted for every Plan. Additionally, a poll of adjacent landowners is encouraged, and may be required by the Department, to identify past, and future land management activities and significant adverse environmental Impacts on adjacent ownerships.

1. Consultation with Experts and Organizations:

- | | |
|---------------------------------|-----------------------------------|
| (a) County Planning Department; | (b) Biologists; |
| (c) Geologists; | (d) Soil Scientists; |
| (e) Hydrologists; | (f) Federal Agencies; |
| (g) State Agencies; | (h) Public and private utilities. |

2. Records Examined:

- | | |
|--|------------------------------------|
| (a) Soil Maps; | (b) Geology Maps; |
| (c) Aerial Photographs; | (d) Natural Diversity Data Base; |
| (e) Plan Records; | (f) Special Environmental Reports; |
| (g) Topographic Maps; | (h) Basin Plans; |
| (i) Fire History Maps; | |
| (j) Relevant public agency documents or Plans; | |
| (k) Relevant watershed or wildlife studies (published or unpublished); | |
| (l) Available modeling approaches. | |

D. Past Projects and Reasonably Foreseeable Probable Future Projects

Past Projects and Reasonably Foreseeable Probable Future Projects included in the Cumulative Impacts assessment shall be described as follows:

1. Identify and briefly describe the location of Past Projects and Reasonably Foreseeable Probable Future Projects within assessment areas. Include a map or maps and associated legend(s) clearly depicting the following information:

a. Township and Range numbers and Section lines.

b. Boundary of the planning watershed(s) which the Plan area is located along with the CALWATER 2.2 Planning Watershed number(s).

c. Location and boundaries of Past Projects and Reasonably Foreseeable Probable Future Projects on land owned or controlled by the Timberland Owner (of the proposed timber harvest) within the planning watershed(s) depicted in provision (b) above. For purposes of this provision, Past Projects shall be limited to those Projects submitted within ten years prior to submission of the Plan.

d. Silvicultural methods for each of the Past Projects and Reasonably Foreseeable Probable Future Projects depicted in section (c) above. Each specific silvicultural method must be clearly delineated on the map(s), and associated Plan number referenced in the legend or an annotated list. In addition, shading, hatching, or labeling shall be used which clearly differentiates Silvicultural Methods into one of the four categories outlined in Table 1.

e. A north arrow and scale bar (or scale text).

f. Source(s) of geographical information. The map scale shall be large enough to clearly represent one Planning Watershed per page or of a scale not less than 1:63,360. Planning Watersheds with densely situated or overlapping harvest units, or those which are large or irregular in size, may require multiple maps to achieve clarity. Color coding on maps may be used if they are able to be reproduced in black and white and clearly show all details. A legend shall be included indicating the meaning of the symbols used. Additionally, maps shall be submitted on 8.5 by 11 page(s).

CALIFORNIA FOREST PRACTICE RULES

Table 1

Silvicultural Category	Silvicultural Method
Evenaged Management 14 CCR § 913.1 [933.1, 953.1]	Clearcutting, Seed Tree Seed Step, Seed Tree Removal Step, Shelterwood Preparatory Step, Shelterwood Seed Step, Shelterwood Removal Step
Unevenaged Management 14 CCR § 913.2 [933.2, 953.2]	Selection, Group Selection, Transition
Intermediate Treatments 14 CCR § 913.3 [933.3, 953.3]	Commercial Thinning, Sanitation-Salvage
Special Prescriptions and Other Management 14 CCR § 913.4 [933.4, 953.4]	Special Treatment Area Prescriptions, Rehabilitation of Understocked Area Prescription, Fuelbreak/Defensible Space, Southern Subdistrict Special Harvesting Method (14 CCR § 913.8), Variable Retention, Conversion
Alternative Prescriptions shall be put into the category within which the most nearly appropriate or feasible silvicultural method in the Forest Practice Rules is found pursuant to 14 CCR § 913.6 (b)(3)[933.6(b)(3), 953.6(b)(3)].	

2. Identify and give the location and description of any known, continuing significant adverse environmental Impacts caused by Past Projects. The RPF shall use their knowledge of the assessment areas, if any, regarding past Impacts, Impacts of the proposed operations, rates of recovery and land uses.

APPENDIX

**TECHNICAL RULE ADDENDUM NO. 2
CUMULATIVE IMPACTS ASSESSMENT GUIDELINES**

This Appendix provides guidelines for evaluating Cumulative Impacts to resource subjects listed in 14 CCR § 912.9(c). The Appendix includes factors, and methods for analysis, that can be considered or used to determine if the Project has a reasonable potential to cause or add to significant adverse Cumulative Impacts.

A. WATERSHED RESOURCES

Cumulative watershed Effects (CWEs) occur within and near bodies of water or Wet Meadows and Other Wet Areas, where individual Impacts are combined to produce an effect that is greater than any of the individual Impacts acting alone. Factors to consider in the evaluation of CWEs include those listed below. The factors described are general and may not be appropriate for all situations. In some cases, measurements may be required for evaluation of the potential for significant adverse Effects. The evaluation of Impacts to watershed resources is based on significant adverse on-site and off-site Cumulative Impacts on Beneficial Uses. Additionally, the Plan must comply with the quantitative or narrative water quality objectives set forth in an applicable Water Quality Control Plan.

1. Watershed Effects produced by timber harvest and other activities, which may include one or more of the following:

a. Sediment Effects. Sediment-induced CWEs occur when earth materials transported by surface or mass wasting erosion enter a Watercourse or Watercourse system at separate locations and are then combined at a downstream location to produce a change in water quality or channel condition. The eroded materials can originate from the same or different Projects. Sediment is composed of both suspended and bedload material. Suspended sediment is usually the primary source of turbidity in forested watersheds, although suspended organic material also accounts for a proportion of the suspended load. Chronic turbidity can be an indicator of a Cumulative Impact when sources can be identified and linked to one or more Projects. Both turbidity and suspended sediment concentrations are

CALIFORNIA FOREST PRACTICE RULES

subject to extreme inherent variability from region to region, storm to storm, and from year to year, dependent upon underlying geology and precipitation.

Potentially adverse Impacts are most likely to occur in the following locations and situations:

- Downstream areas of low Watercourse gradient where sediment from a new source may be deposited in addition to sediment derived from existing or other new sources.
- Immediately downstream from where sediment from a new source is combined with sediment from other new or existing sources and the combined amount of sediment exceeds the transport capacity of the Watercourse.
- Any location where sediment from new sources in combination with suspended sediment from existing or other new sources significantly increases turbidity, reduces the survival of fish or other aquatic organisms, or otherwise reduces the Quality of Waters used for domestic, agricultural, or other Beneficial Uses.
- Channels with relatively steep gradients which contain accumulated sediment and debris that can be mobilized by sudden new sediment inputs, such as debris flows, resulting in debris torrents and severe channel scouring.

Potentially significant adverse Impacts of cumulative sediment inputs may include:

- Increased treatment needs or reduced suitability for domestic, municipal, industrial, or agricultural water use.
- Direct mortality of fish and other aquatic Species.
- Impaired spawning and rearing habitat for salmonids or otherwise reduced viability of aquatic organisms, or disruption of aquatic habitats, and loss of Watercourse productivity caused by filling of pools and plugging or burying gravel.
- Accelerated channel filling (aggradation) resulting in loss of streamside vegetation and Watercourse migration that can cause accelerated bank erosion.
- Accelerated channel filling (aggradation) resulting in increased frequency and magnitude of overbank flooding.
- Accelerated filling of downstream reservoirs, navigable channels, water diversion and transport facilities, estuaries, and harbors.
- Channel scouring by debris flows and torrents.
- Nuisance to or reduction in water related recreational activities.

Situations where sediment production potential is greatest include:

- Sites with high or extreme Erosion Hazard Ratings.
- Sites which are tractor logged on steep slopes.
- Unstable Areas.

b. Water Temperature Effects. Water temperature-related CWEs are changes in water chemistry or biological properties caused by the combination of solar-warmed water from two or more locations where natural cover has been removed (in contrast to an individual effect that results from Impacts along a single Class I or II Watercourse segment). Cumulative Impacts from water temperature are most likely to occur in the following situations:

- Where Class I or II Watercourse bottom materials are dark in color.
- Where water is shallow and has little underflow.
- Where removal of streamside Canopy results in substantial, additional solar exposure or increased contact with warm air at two or more locations along a Class I or II Watercourse.
- Where removal of streamside Canopy results in substantial, additional solar exposure or increased contact with warm air at two or more Class I or II Watercourses that are tributary to a larger Class I or II Watercourse.
- Where water temperature is near a biological threshold for specific Species.

Significant adverse Impacts of cumulative temperature increases include:

- Increases in the metabolic rate of aquatic Species.
- Direct increases in metabolic rate and/or reduction of dissolved oxygen levels, either of which can cause reduced vigor and death of sensitive fish and other sensitive aquatic organisms.
- Increased growth rates of microorganisms that deplete dissolved oxygen levels or increased disease potential for organisms.

CALIFORNIA FOREST PRACTICE RULES

- Class I or II Watercourse biology shifts toward warmer water ecosystems.

c. Organic Debris Effects. CWEs produced by organic debris can occur when logs, limbs, and other organic material are introduced into a Watercourse or Lake at two or more locations. Decomposition of this debris, particularly the smaller sized and less woody material, removes dissolved oxygen from the water and can cause Impacts similar to those resulting from increased water temperatures. Introduction of excessive small organic debris can also increase water acidity. Conversely, large organic debris is an important stabilizing agent in small to medium size, steep gradient channels. However, the sudden introduction of large, unstable volumes of debris (such as logs, chunks, and larger limbs produced during a logging operation) can obstruct and divert streamflow against erodible banks, block fish migration, and may cause debris torrents during periods of high flow. Additionally, removing streamside vegetation can reduce the natural, annual inputs of litter to the Watercourse. This can cause both a drop in food supply, and resultant productivity, and a change in types of food available for organisms that normally dominate the lower food chain of Watercourses with an overhanging or adjacent forest Canopy.

d. Chemical Contamination Effects. Potential sources of chemical CWEs include run-off from roads treated with oil or other dust-retarding materials, direct application or run-off from pesticide treatments, contamination by equipment fuels and oils, and the introduction of nutrients released during burning of Slash and Woody Debris or wildfire from two or more locations.

e. Peak Flow Effects. CWEs can be caused by management-induced peak flow increases in Watercourses during storm events. Peak flow increases may result from management activities that reduce rainfall interception (i.e., evaporation) and vegetative water use (i.e., transpiration), or produce openings where snow can accumulate, such as in clearcuts and on roads and Landings). While increases, if any, are likely to be small relative to pre-harvest peak flows, extensive Canopy removal over a short period of time on a watershed scale can increase peak flow Effects on streambank erosion, channel incision, and headward channel extension in erodible landscapes. The timing and concentration of flows affecting lower order Watercourse channel morphology can also be affected by the routing of runoff from roads, Landings, and skid trails. Peak flow Effects diminish with decreasing intensity of Canopy removal, increasing time since harvest, and during larger flow recurrence intervals.

2. Watercourse Condition. The watershed Impacts of past upstream and on-site Projects are often reflected in the condition of Watercourse channels on the Project area. The following is a list of channel characteristics and factors commonly used to describe current watershed conditions and to assist in the evaluation of potential Project Impacts:

a. Gravel Embedded - Spaces between gravel filled with sand or finer sediments. Gravel are often in a tightly packed arrangement.

b. Pools Filled - Former pools or apparent pool areas filled with sediments leaving few areas of deep or “quiet” water relative to Watercourse flow or size.

c. Aggrading - Watercourse channels filled or filling with sediment that raises the channel bottom elevation. Pools will be absent or greatly diminished and gravel may be embedded or covered by finer sediments. Streamside vegetation may be partially or completely buried, and the Watercourse may be meandering or cutting into its banks above the level of the former streambed. Depositional areas in aggrading channels are often increasing in size and number.

d. Bank Cutting - Can either be minor or severe and is indicated by areas of fresh, unvegetated soil or alluvium exposed along the Watercourse Banks, usually above the low-flow channel and often with a vertical or undercut face. Severe bank cutting is often associated with channels that are downcutting, which can lead to over-steepened banks, or aggrading, which can cause the channel to migrate against slopes that were previously above the high flow level of the Watercourse.

e. Bank Mass Wasting - Channels with landslides directly entering the Watercourse system. Slide movement may be infrequent (single events) or frequent (continuing creep or periodic events).

f. Downcutting - Incised Watercourse channels with relatively clean, uncluttered beds cut below the level of former streamside vegetation and with eroded, often undercut or vertical, banks.

g. Scoured - Watercourse channels that have been stripped of gravel and finer bed materials by large flow events or debris torrents. Streamside vegetation has often been swept away, and the channel has a raw, eroded appearance.

CALIFORNIA FOREST PRACTICE RULES

h. Organic Debris - Debris in the Watercourse can have either a positive or negative Impact depending on the amount and stability of the material. Some stable organic debris present in the Watercourse helps to form pools and retard sediment transport and downcutting in small to medium sized Watercourses with relatively steep gradients. Conversely, large accumulations of organic debris can block fish passage, block or divert Watercourse flow, or could be released as a debris flow.

i. Streamside Vegetation - Streamside and adjoining vegetation provide shade or cover to the Watercourse, which may have an Impact on water temperature, and provide root systems that stabilize streambanks and floodplains and filter sediment from Flood Flows.

j. Recent Floods - A recent high flow event that would be considered unusual in the Project area may have an Impacts on the current Watercourse condition.

B. SOIL PRODUCTIVITY

Cumulative soil productivity Impacts occur when the Effects of two or more activities, from the same or different Projects, combine to produce a significant decrease in soil biomass production potential. These Impacts most often occur on-site within the Project boundary, and the relative severity of productivity losses for a given level of Impact generally increases as site quality declines. Factors to consider in the evaluation of Cumulative Impacts influencing soil productivity are listed below:

1. Organic Matter Loss. Displacement or loss of organic matter can result in a long-term loss of soil productivity. Soil surface litter and downed wood are the store-house of long term soil fertility, provide for soil moisture conservation, and support soil microorganisms that are critical in the nutrient cycling and uptake process. Much of the chemical and microbial activity of the forest nutrient cycle is concentrated in the narrow zone at the soil and litter interface.

Displacement of surface organic matter occurs as a result of Skidding, Mechanical Site Preparation, and other land disturbing Timber Operations. Actual loss of organic matter occurs as a result of burning or erosion. The effects of organic matter loss on soil productivity may be expressed in terms of the percentage displacement or loss as a result of all Project activities.

2. Surface Soil Loss. The soil is the store-house of current and future site fertility, and the majority of nutrients are held in the upper few inches of the soil profile. Topsoil displacement or loss can have an immediate effect on site productivity, although Effects may not be obvious because of reduced brush competition and lack of side-by-side comparisons or until the new stand begins to fully occupy the available growing space.

Surface soil is primarily lost by erosion or by displacement into windrows, piles, or Fills. Mass wasting is a special case of erosion with obvious extreme effects on site productivity. The Impacts of surface soil loss may be evaluated by estimating the proportion of the Project area affected and the depth of loss or displacement.

3. Soil Compaction. Compaction affects site productivity through loss of large soil pores that transmit air and water in the soil and by restricting root penetration. The risk of compaction is associated with:

- a. Depth of surface litter.
- b. Soil structure.
- c. Soil organic matter content.
- d. Presence and amount of coarse fragments in the soil.
- e. Soil texture.
- f. Soil moisture status.

Compaction Effects may be evaluated by considering the soil conditions, as listed above, at the time of harvesting activities and the proportion of the Project area subjected to compacting forces.

4. Growing Space Loss. Forest growing space is lost to roads, Landings, permanent skid trails, and other permanent or non-restored areas subjected to severe disturbance and compaction. The Effects of growing space loss may be evaluated by considering the overall pattern of roads, etc., relative to Feasible Silvicultural Systems and Yarding methods.

CALIFORNIA FOREST PRACTICE RULES

C. BIOLOGICAL RESOURCES

Significant adverse Cumulative Impacts may be expected where there is a substantial reduction in required habitat or the Project will result in substantial interference with the movement of resident or migratory Species. Biological assessment areas can vary with the habitat and Species being evaluated. Factors to consider in the evaluation of cumulative biological Impacts include:

1. Any known Listed Species that may be directly or indirectly affected by Project activities.

2. Any significant, known wildlife or fisheries resource concerns within the immediate Project area and the biological assessment area (e.g. loss of oaks creating forage problems for a local deer herd, Species requiring special elements, and significant natural areas).

The significance of Cumulative Impacts on non-listed Species viability may be determined relative to the benefits to other non-listed Species. For example, the manipulation of habitat results in conditions which discourage the presence of some Species while encouraging the presence of others.

3. The aquatic and near-water habitat conditions within the Plan and immediate surrounding area. Habitat conditions of major concern are: Pools and riffles, large woody material in the Watercourse, and near-water vegetation. Much of the information needed to evaluate these factors is described in the watershed resources provision. A general discussion of their importance is provided below:

a. Pools and Riffles. Pools and riffles affect overall habitat quality and fish community Structure. Watercourses with little structural complexity offer poor habitat for fish communities as a whole, even though the channel may be stable. Structural complexity is often lower in Watercourses with low gradients, and filling of pools can reduce Watercourse productivity.

b. Large Woody Material. Large woody material in Watercourses play an important role in creating and maintaining habitat through the formation of pools. These pools comprise important feeding locations that provide maximum exposure to drifting food organisms in relatively quiet water. Removal of large woody material can reduce frequency and quality of pools.

c. Near-water Vegetation. Near-water vegetation provides many habitat benefits, including: shade, nutrients, vertical diversity, migration corridors, nesting, roosting, and escape. Recruitment of large woody material is also an important element in maintaining habitat quality.

4. The biological habitat condition of the Plan and immediate surrounding area. The following factors are commonly used when evaluating biological habitat. The factors described are general and may not be appropriate for all situations. The RPF may also need to consider factors which are not listed below. Each set of ground conditions are unique and the assessment conducted must reflect those conditions.

a. Snags/Den Trees/Nest Trees: Snags, den trees, Nest Trees and their recruitment are required elements in the overall habitat needs of more than 160 wildlife Species. Many of these Species play a vital role in maintaining the overall health of Timberlands. Snags of greatest value are >16 in. dbh and 20 ft. in height. The degree of Snag recruitment over time may be considered. Den trees are partially live trees with elements of decay which provide wildlife habitat. Nest Trees have importance to birds classified as Sensitive Species.

b. Downed Large Woody Material: Large downed logs (particularly conifers) in the upland and near-water environment in all stages of decomposition provide an important habitat for many wildlife Species. Large woody material of greatest value consists of downed logs >16 in. diameter at the large end and >20 ft. in length.

c. Multistory Canopy: Upland multistoried canopies have a marked influence on the diversity and density of wildlife Species utilizing the area. More productive Timberland is generally of greater value and timber site capability may be considered as a factor in an assessment. The amount of upland multistoried Canopy may be evaluated by estimating the percent of the stand composed of two or more tree layers on an average per-acre basis.

Near-water multistoried canopies in Riparian zones that include conifer and hardwood tree Species provide an important element of structural diversity to the habitat requirements of wildlife. Near-water multistoried Canopy may be evaluated by estimating the percentage of ground covered by one or more Canopy strata, with more emphasis placed on shrub Species along Class III and IV Watercourses (14 CCR §§ 916.5, 936.5, or 956.5).

CALIFORNIA FOREST PRACTICE RULES

d. Road Density: Frequently traveled roads have a significant influence on wildlife use of otherwise suitable habitat. Declines in deer and bear use of areas adjacent to open roads are frequently noted. Road density influence on large mammal habitat may be evaluated by estimating the miles of roads, on a per-section basis, that are open to the public. This assessment can also account for the Effects of vegetation screening and the relative importance of an area to wildlife on a seasonal basis (e.g. winter range).

e. Hardwood Cover: Hardwoods are an important habitat component in Cumulative Impact assessment, because they often provide Snags, den trees, downed large woody material, multistory Canopy, cover, mast, late seral forest characteristics, and connectivity between habitats. Hardwoods provide an important element of habitat diversity in the coniferous forest and are utilized as a source of food and/or cover by a large proportion of the state's bird and mammal Species. Productivity of deer and other Species has been directly related to mast crops. Hardwood cover can be estimated using the Basal Area Per Acre provided by hardwoods of all Species.

f. Late Seral (Mature) Forest Characteristics:

Determination of the presence or absence of late seral (mature) forest characteristics provides a basis from which to begin an assessment of the influence of management on associated wildlife. These characteristics include large trees as part of a multilayered Canopy, large decadent trees, and the presence of large numbers of Snags and downed logs, all of which contribute to an increased level of stand decadence and complexity. Late seral forests may be evaluated by estimating the percentage of the land base within the Plan and the biological assessment area occupied by areas conforming to the following definitions:

- Forests not previously harvested that are at least 80 acres in size to maintain the effects of edge. This acreage is variable based on the degree of similarity in surrounding areas. The stand includes a multi-layered Canopy, two or more tree Species with several large coniferous trees per acre (smaller subdominant trees may be either conifers or hardwoods), large conifer Snags, and an abundance of large woody material.

- Previously harvested forests that are in many possible stages of succession and may include remnant patches of late seral forest which generally conform to the definition of unharvested forests but do not meet the acreage criteria.

g. Late Seral Habitat Continuity: The fragmentation and resultant isolation of late seral habitat types is one of the most significant factors influencing the sustainability of wildlife populations not adapted to edge environments. This fragmentation may be evaluated by estimating the number of acres within the Project area, as well as the biological assessment area occupied by portions of or entire late seral stands at least 80 acres in size (considering the mitigating influence of adjacent and similar habitat, if applicable) and less than one mile apart, or connected by a corridor of similar habitat.

h. Special Habitat Elements: Special habitat elements are specific physical and biological attributes of the landscape without which certain Species are not expected to be present or, if present, are at relatively low population numbers. The biological assessment area may contain special habitat or critical Functional elements that are not otherwise discussed within this Appendix (e.g., meadows that may be critical for fawning success of local deer population, etc...). Each Species may have several key limiting factors to consider during the assessment of Cumulative Impacts.

D. RECREATIONAL RESOURCES

The recreational assessment area is generally the area that includes the Logging Area plus 300 feet. Factors to consider in assessing recreational Cumulative Impacts include:

1. The recreational activities involving significant numbers of people in and within 300 ft. of the Logging Area (e.g., fishing, hunting, hiking, picnicking, camping).

2. Any recreational Special Treatment Areas described in the Rules on the Plan area or contiguous to the area.

CALIFORNIA FOREST PRACTICE RULES

E. VISUAL RESOURCES

The visual assessment area is generally the Project area that is readily visible to significant numbers of people who are no further than three miles from the Project area. Factors to consider in the assessment of visual Cumulative Impacts include:

1. Any Special Treatment Areas designated as such by the Board because of their visual values.
2. How far from the proposed Project area is the nearest point that significant numbers of people can view the Project area. At distances of greater than 3 miles from viewing points activities are not easily discernible and will be less significant.
3. The manner in which the public identified in 1 and 2 above will view the proposed Timber Operation (from a vehicle on a public road, from a stationary public viewing point or from a pedestrian pathway).

F. VEHICULAR TRAFFIC IMPACTS

The traffic assessment area involves the first roads not part of the Logging Area on which logging traffic must travel. Factors to consider in assessing traffic Cumulative Impacts include:

1. Whether any publicly owned roads will be used for the transport of wood products.
2. Any Public Roads that have not been used recently for the transport of wood products and will be used to transport wood products from the proposed Timber Operations.
3. Any Public Roads that have existing traffic or maintenance problems.
4. How the logging vehicles used in the Timber Operation will change the amount of traffic on Public Roads, especially during heavy traffic conditions.

G. GREENHOUSE GAS (GHG) IMPACTS

Forest management activities may affect GHG sequestration and emission rates of forests through changes to forest inventory, growth, yield, and mortality. Timber Operations and subsequent production of wood products, and in some instances energy, can result in the emission, storage, and offset of GHGs. One or more of the following options can be used to assess the potential for significant adverse cumulative GHG Effects:

1. Incorporation by reference, or tiering from, a programmatic assessment that was certified by the Board, CAL FIRE, or other State Agency, which analyzes the net Effects of GHG associated with forest management activities.
2. Application of a model or methodology quantifying an estimate of GHG emissions resulting from the Project. The model or methodology should at a minimum consider the following:
 - a. Inventory, growth, and harvest over a specified planning horizon
 - b. Projected forest carbon sequestration over the planning horizon
 - c. Timber Operation related emissions originating from logging equipment and transportation of logs to manufacturing facility
 - d. GHG emissions and storage associated with the production and life cycle of manufactured wood products.
3. A qualitative assessment describing the extent to which the Project in combination with Past Projects and Reasonably Foreseeable Probable Future Projects may increase or reduce GHG emissions compared to the existing environmental setting. Such assessment should disclose if a known 'threshold of significance' (14 CCR § 15064.7) for the Project type has been identified by the Board, CAL FIRE or other State Agency and if so whether or not the Project's emissions in combination with other forestry Projects are anticipated to exceed this threshold.

H. WILDFIRE RISK AND HAZARD

Cumulative increase in wildfire risk and hazard can occur when the Effects of two or more activities from one or more Projects combine to produce a significant increase in forest fuel loading in the vicinity of residential dwellings and communities.

The following elements may be considered in the assessment of potential Cumulative Impacts:

1. Fire hazard severity zoning.

CALIFORNIA FOREST PRACTICE RULES

2. Existing and probable future fuel conditions including vertical and horizontal continuity of live and dead fuels.
3. Location of known existing public and private Fuelbreaks and fuel hazard reduction activities.
4. Road access for fire suppression resources.

I. OTHER

Within an assessment area there may be evidence of potential Cumulative Impacts to resource subjects that are not listed elsewhere within this Appendix, but which merit assessment. The assessment of any other resource subjects should focus on the factors and elements pertinent to the assessment of Cumulative Impacts related to those subjects.

Article 3 Silvicultural Methods

913, 933, 953 Silvicultural Objectives [All Districts]

The objectives of this article are to describe standard silvicultural systems and to provide for alternatives that when applied shall meet the objectives of the FPA (PRC 4512 and 4513). The RPF shall select systems and alternatives which achieve maximum sustained production of high quality timber products. The THP shall designate one or a combination of regeneration methods, prescriptions or intermediate treatments described by this article. If a method, prescription or treatment not defined in the Rules (see 14 CCR 895.1) is to be used, an alternative prescription shall be included in the plan. The assessment of maximum sustained production of high quality timber products is based on:

- (a) Regeneration methods, intermediate treatments and prescriptions described in the Rules which establish standards. These methods, treatments, prescriptions, and standards shall not be utilized to permit harvesting of growing stock in a manner that will significantly delay reaching or maintaining maximum sustained production.
- (b) Published yield tables or other tools which can be validated and which serve as a point of reference for evaluating and selecting silvicultural systems and their implementation.
- (c) The Sustained Yield Plan: The SYP establishes the flow of forest products from managed Timberlands, and shall demonstrate the achievement of maximum sustained production.
- (d) An assessment of maximum sustained production of high quality timber products is not required for a harvest pursuant to 14 CCR § 913.4 [933.4, 953.4]. Because these lands are designated as defensible space or Fuelbreak areas, the wood production potential of these lands is compatible with the lowest site classifications and they shall be considered site IV Timberland for stocking purposes.

913.1, 933.1, 953.1 Regeneration Methods Used in Evenaged Management [All Districts; Note variation by District in (a)(4)(A) and (d)(3) Shelterwood Removal Step]

The following types of regeneration methods are designed to replace a harvestable stand with well-spaced growing trees of commercial species. Evenaged management systems shall be applied with the limitations described by this rule:

- (a) Timber stands harvested under an evenaged regeneration method shall meet the following standards:
 - (1) Where a regeneration step harvest of evenaged management will occur on stands younger than 50 years of age for Class I lands, 60 years of age for Class II and III lands, or 80 years of age for Class IV and V lands, or equivalent age of trees, based on height as determined according to the appropriate site class, the RPF preparing the THP or SYP must demonstrate how the proposed harvest will achieve MSP pursuant to 14 CCR § 913.11 [933.11, 953.11](a) or (b) provided, however, that the Director may grant an exemption from this section based upon hardship.
 - (2) The regeneration harvest of evenaged management shall be limited to 20 acres for tractor Yarding. Aerial or Cable Yarding may be 30 acres. Tractor Yarding may be increased to 30 acres where the EHR is low and the slopes are < 30%. The RPF may propose increasing these acreage limits to a maximum of 40 acres, and the Director may agree where measures contained in the THP provide substantial evidence that the increased acreage limit does any one of the following:
 - (A) by using additional on-site mitigation measures, reduces the overall detrimental effects of erosion thereby providing better protection of soil, water, fish and/or wildlife resources; or

CALIFORNIA FOREST PRACTICE RULES

- (B) provides for the inclusion of "long corners"; or
- (C) create a more natural logging unit by taking maximum advantage of the topography; or
- (D) will increase long-term sustained yield; or
- (E) provide feasible off-site mitigation measures that can be incorporated in the plan to

restore or enhance previously Impacted resource areas or other environmental enhancements that will result in demonstrable net environmental benefits within the planning watershed. These measures may include, but are not limited to, Watercourse restoration, soil stabilization, road surface stabilization, road outcropping, road Abandonment, road reconstruction, enhancement of wildlife habitats and vegetation management. To qualify for an exemption the plan submitter is not required to demonstrate that other feasible options are not available.

(3) Evenaged regeneration units within an ownership shall be separated by a logical logging unit that is at least as large as the area being harvested or 20 acres, whichever is less, and shall be separated by at least 300 ft. in all directions.

(4) Within ownership boundaries, no logical logging unit contiguous to an evenaged management unit may be harvested using an evenaged regeneration method unless the following are met:

(A) [Coast] The prior evenaged regeneration unit has an approved report of stocking, and the dominant and codominant trees average at least five years of age or average at least five ft. tall and three years of age from the time of establishment on the site, either by the planting or by natural regeneration. If these standards are to be met with trees that were present at the time of the harvest, there shall be an interval of not less than five years following the completion of operations before adjacent evenaged management may occur.

(A) [Northern and Southern] The prior evenaged regeneration unit has an approved report of stocking, and the dominant and codominant trees average at least five feet tall, or at least five years of age from the time of establishment on the site, either by the planting or by natural regeneration. If these standards are to be met with trees that were present at the time of the harvest, there shall be an interval of not less than five years following the completion of operations before adjacent evenaged management may occur.

(5) Except for the clearcut method, all trees to be harvested or all trees to be retained shall be marked by, or under the supervision of, an RPF prior to felling operations. A sample area shall be marked prior to a preharvest inspection. The sample area shall include at least 10% of the harvest area up to a maximum of 20 acres per stand type, and must be representative of the range of conditions present in the area. The marking requirement may be waived by the Director if the trees to be harvested are easily distinguished from the trees to be retained, when explained and justified by the RPF in the plan.

(6) Special consideration for aesthetic enjoyment shall be given to selection of silvicultural treatments and Timber Operations within 200 feet of the edge of the traveled surface of any Permanent Road maintained by the County, or the State.

(7) Special consideration for aesthetic enjoyment and protection of adjacent stand vigor shall be given to the selection of silvicultural methods and Timber Operations within 200 feet of adjacent non-federal lands not zoned TPZ.

(b) **Clearcutting** The clearcutting regeneration method involves the removal of a stand in one harvest. Regeneration after harvesting shall be obtained by direct seeding, planting, sprouting, or by natural seed fall. When practical, clearcuts shall be irregularly shaped and variable in size in order to mimic natural patterns and features found in landscapes. Site Preparation and Slash disposal measures, if necessary for successful regeneration, shall be described in the plan.

(c) **Seed Tree** The seed tree regeneration method involves the removal of a stand in one harvest except for well distributed seed trees of desired species which are left singly or in groups to restock the harvested area. The seed step is utilized to promote natural reproduction from seed and to initiate the establishment of an evenaged stand. The removal step may be utilized to remove the seed trees after a fully stocked stand of reproduction has become established.

(1) **Seed Tree Seed Step:** The seed tree seed step is the regeneration step and shall meet the following requirements:

(A) Retention of at least the following basal area of seed trees per acre which are 18 inches dbh or greater:

CALIFORNIA FOREST PRACTICE RULES

1. Fifteen square feet basal area on site I, II and III lands and
2. Twelve square feet basal area on site IV and V lands.

The seed trees must be of full crown, capable of seed production and representative of the best phenotypes available in the preharvest stand.

(B) No point within the logged area shall be more than 150 feet from a seed tree.

(C) Seed tree species and Site Preparation measures shall be specified in the plan by the RPF.

(D) Seed trees shall be marked by or under the supervision of an RPF prior to felling operations.

(E) If natural regeneration is inadequate within two years after the first August following completion of Timber Operations, seed trees may be harvested and artificial regeneration shall be used to meet the requirements of 14 CCR § 912.7(b)(1) [932.7(b)(1), 952.7(b)(1)].

(F) In the absence of a Sustained Yield Plan, to maintain and improve tree species diversity, genetic material and seed production, trees of each native commercial species where present at the time of harvest shall be retained after harvest. These leave trees shall be representative of the best phenotypes available in the preharvest stand. The RPF may propose and the Director may agree to a species specific plan in the THP which protects existing regeneration or provides for regeneration in-lieu of retaining trees.

(2) Seed Tree Removal Step Not more than 15 predominant trees per acre may be removed in the seed tree removal step. Not more than 50 sq. ft. of basal area of predominant trees per acre may be removed in the seed tree removal step. The seed tree removal step may be utilized when the regeneration present exceeds the minimum stocking requirements set forth in 14 CCR § 912.7(b)(1) [932.7(b)(1), 952.7(b)(1)]. Regeneration shall not be harvested under the seed tree method unless the trees are dead, dying or diseased or substantially damaged during Timber Operations. The minimum stocking standards of 14 CCR § 912.7(b)(1) [932.7(b)(1), 952.7(b)(1)] shall be met immediately upon completion of operations. The seed tree removal step shall only be used once in the life of the stand unless otherwise agreed to by the Director.

If the extent and intensity of the soil and vegetation disturbance caused by the harvest is similar to what would have been caused by a clearcut, the size limitations, separation (spacing) by logical logging unit requirements, and Yarding equipment limitations of 14 CCR § 913.1(a) [933.1(a), 953.1(a)] are applicable.

(d) Shelterwood The shelterwood regeneration method reproduces a stand via a series of harvests (preparatory, seed, and removal). The preparatory step is utilized to improve the crown development, seed production capacity and wind firmness of designated seed trees. The seed step is utilized to promote natural reproduction from seed. The removal step is utilized when a fully stocked stand of reproduction has become established, and this step includes the removal of the protective overstory trees. The shelterwood regeneration method is normally utilized when some shade canopy is considered desirable for the establishment of regeneration.

(1) Shelterwood Preparatory Step The shelterwood preparatory step shall meet the following minimum standards:

(A) At least the following basal area of seed trees per acre which are 18 inches dbh or greater shall be retained.

1. Thirty square feet basal area on site I, II and III lands and
2. Twenty four square feet basal area on site IV and V lands.

The seed trees must be of full crown, capable of seed production and representative of the best phenotypes available in the preharvest stand.

(B) No point within the logged area shall be more than 100 ft. from a seed tree.

(C) Seed tree species shall be specified in the plan by the RPF.

(D) At least 125 sq. ft. of Basal Area Per Acre on Site I lands, and 75 sq. ft. of Basal Area Per Acre on Site II and III lands and 50 sq. ft. of Basal Area Per Acre on site IV and V lands shall be retained.

(E) The minimum stocking standards of 14 CCR § 912.7(b)(1) [932.7(b)(1), 952.7(b)(1)] shall be met immediately upon completion of operations. Within six months following completion of work described in the plan, a report of stocking shall be filed as stated in PRC § 4587.

(2) Shelterwood Seed Step The shelterwood seed step is the regeneration step and shall meet the following standards:

CALIFORNIA FOREST PRACTICE RULES

(A) At least the following basal area of seed trees per acre which are 18 inches dbh or greater shall be retained.

1. Thirty square feet basal area on site I, II and III lands and
2. Twenty four square feet basal area on site IV and V lands.

The seed trees must be of full crown, capable of seed production and representative of the best phenotypes available in the preharvest stand.

(B) No point within the logged area shall be more than 100 ft. from a seed tree.

(C) Seed tree species and Site Preparation measures shall be specified in the plan by the RPF.

(D) Seed trees shall be marked by or under the supervision of an RPF prior to felling operations.

(E) If natural regeneration is inadequate within two years after the first August following completion of Timber Operations, seed trees may be harvested and artificial regeneration shall be used to meet the requirements of 14 CCR § 912.7(b)(1), [932.7(b)(1), 952.7(b)(1)].

(F) In the absence of a Sustained Yield Plan, to maintain and improve tree species diversity, genetic material and seed production, trees of each native commercial species where present at the time of harvest shall be retained after harvest. These leave trees shall be representative of the best phenotypes available in the preharvest stand. The RPF may propose and the Director may agree to a species specific plan in the THP which protects existing regeneration or provides for regeneration in-lieu of retaining trees.

(3) Shelterwood Removal Step [Coast only] The shelterwood removal step may be utilized when the regeneration present exceeds the minimum stocking requirements set forth in 14 CCR § 912.7(b)(1). Unless otherwise agreed to by the Director, the Shelterwood removal shall only be used once in the life of the stand. Regeneration shall not be harvested during the shelterwood removal step unless the trees are dead, dying or diseased or substantially damaged by Timber Operations. The minimum stocking standards of 912.7(b)(1) shall be met immediately upon completion of operations. The size limitations, and separation (spacing) by logical logging unit requirements, of 14 CCR § 913.1(a) are applicable unless the post-harvest stand, regardless of average diameter, meets the stocking standards of 14 CCR § 913.3(a)(1)(A) or (B)]. Not more than 32 predominant trees per acre may be removed in the shelterwood removal step. Not more than 100 square feet of basal area of predominant trees per acre may be removed in the shelterwood removal step.

(3) Shelterwood Removal Step [Northern and Southern] The shelterwood removal step may be utilized when the regeneration present exceeds the minimum stocking requirements set forth in 14 CCR § 932.7(b)(1) [952.7(b)(1)]. Unless otherwise agreed to by the Director, the Shelterwood removal shall only be used once in the life of the stand. Regeneration shall not be harvested during the shelterwood removal step unless the trees are dead, dying or diseased or substantially damaged by Timber Operations. The minimum stocking standards of 14 CCR § 932.7(b)(1) [952.7(b)(1)] shall be met immediately upon completion of operations.

If the extent and intensity of the ground disturbance caused by the harvest is essentially the same as would have been caused by a clearcut or will cause adverse cumulative effects on wildlife as determined by the RPF or Director, the size limitations, and separation (spacing) by logical logging unit requirements of 14 CCR § 933.1(a) [953.1(a)] are applicable unless the post-harvest stand, regardless of average diameter, meets area stocking standards of 14 CCR § 933.3(a)(1)(A) or (B) [953.3(a)(1)(A) or (B)].

913.2, 933.2, 953.2 Regeneration Methods Used in Unevenaged Management [All Districts, Note variations by District in (a)(2)(A)(1), (b)(6)]

Unevenaged management is utilized to establish and maintain an unevenaged stand structure. Unevenaged management attributes include the establishment and/or maintenance of a multi-aged, balanced stand structure, promotion of growth on leave trees throughout a broad range of Diameter classes, and encouragement of natural Reproduction.

(a) Selection Under the selection regeneration method, the trees are removed individually or in small groups sized from one-quarter (.25) acres to two and one-half (2.5) acres.

(1) Trees to be harvested or trees to be retained shall be Marked by or under the supervision of the RPF prior to felling operations. When openings greater than one-quarter (.25) acres will be created, the boundaries of the Small Group(s) may be designated in lieu of Marking individual trees within the Small

CALIFORNIA FOREST PRACTICE RULES

Group areas. A sample area must be Marked prior to a preharvest inspection for evaluation. The sample area shall include at least ten (10) percent of the Harvest Area up to a maximum of twenty (20) acres per stand type which is representative of the range of conditions present in the area.

(2) Post-harvest stand stocking levels shall be stated in the THP. The level of residual stocking shall be consistent with maximum sustained production of high quality timber products. In no case shall stocking be reduced below the following standards:

(A) Selection System.

1. [Coast] On Site I lands at least one hundred twenty-five (125) square feet per acre of basal area shall be retained.

1. [Northern, Southern] On Site I lands at least one hundred (100) square feet per acre of basal area shall be retained.

2. On Site II and III lands at least seventy-five (75) square feet per acre of basal area shall be retained.

3. On Site IV and V lands at least fifty (50) square feet per acre of basal area shall be retained.

4. Unless the plan submitter demonstrates how the proposed harvest will achieve MSP pursuant to 14 CCR § 913.11 [933.11, 953.11] (a) or (b), the residual stand shall contain trees that are representative of the best phenotypic quality of the preharvest stand.

(B) Group Selection.

1. At least two thirds of the stocked plots must meet the Basal Area Stocking Standards of 14 CCR § 913.2(a)(2)(A), [933.2(a)(2)(A); 953.2(a)(2)(A)].

2. Not more than one third of the stocked plots may meet Stocking Standards utilizing the standards of 14 CCR § 912.7(b)(1), [932.7(b)(1); 952.7(b)(1)]. The minimum required age of the trees utilized under these standards shall be ten (10) years old, and shall be based on the percentage of the Plan area harvested by this method in Small Group clearings as described in the table below:

Percentage of stand harvested as small group clearings	Minimum age of trees utilizing the standards of 14 CCR § 912.7(b)(1)
20.0% or less	10
20.1-22%	11
22.1-24%	12
24.1-26%	13
26.1-28%	14
28.1-30%	15
30.1-32%	16
32.1-33.33%	17

3. An RPF or Supervised Designee may offset a certain number of plots per forty (40) plots where those plot centers are initially placed within Small Group clearings created during the current harvest. The maximum number of offset plots shall be based on the percentage of the Plan area harvested by this method in Small Group clearings as described in the table below. Unless substantially damaged by fire, the RPF or supervised designee shall not exclude Small Group clearings created by previous timber harvesting from the stocking survey.

Percentage of stand harvested as small group clearings	Maximum number of allowable offset plots
20.0% or less	8
20.1-22.9%	9

CALIFORNIA FOREST PRACTICE RULES

23.0-24.9%	10
25.0-27.9%	11
28.0-29.9%	12
30.0-33.33%	13

4. Unless the plan submitter demonstrates how the proposed harvest will achieve MSP pursuant to 14 CCR § 913.11 [933.11, 953.11] (a) or (b), the residual stand shall contain trees that are representative of the best phenotypic quality of the preharvest stand.

(3) Within any Plan, Small Group clearings under the selection method shall be separated by a logical logging area.

(4) Following completion of Timber Operations (including Site Preparation) not more than one third of the Plan area harvested by this method shall be covered by Small Group clearings.

(5) Exceptions to stocking standards in 14 CCR § 913.2(a)(2), [933.2(a)(2), 953.2(a)(2)] above may be granted only when proposed by the RPF and explained and justified in the plan, but in no case will the exceptions be less than specified in 14 CCR § 912.7 (b)(2), [932.7(b)(2), 952.7(b)(2)]. Exceptions may only be granted when the RPF clearly demonstrates that the existing stand will grow substantially less than both the potential site productive capacity and the proposed post-harvest stand.

(b) Transition. The transition method may be used to develop an unevenaged stand from a stand that currently has an unbalanced irregular or evenaged structure. The transition method involves the removal of trees individually or in small groups from irregular or evenaged stands to create a balanced stand structure and to obtain natural Reproduction.

(1) Area for determination of preharvest seed tree retention levels shall be no greater than twenty (20) acres in size.

(2) This method is to be used to increase stocking and improve the balance of age classes so as to allow the residual stand to be managed by the selection Regeneration Method. This method shall not be used more than two (2) times for a stand. The RPF shall delineate areas previously treated by the transition method on the plan map.

(3) Stands suitable for the transition method contain adequate quantity and quality of seed producing trees to provide adequate regeneration for new age classes. Stands suitable for this method shall have no more than fifty (50) sq. ft. of basal area greater than the selection basal area standards.

(4) Trees to be harvested or trees to be retained shall be Marked by or under the supervision of a RPF before felling operations. A sample area must be Marked before the preharvest inspection for evaluation. The sample area shall include at least ten (10) percent of the Harvest Area up to a maximum of twenty (20) acres per stand type which is representative of the range of conditions present.

(5) Immediately following the completion of Timber Operations, the minimum basal area standards in 14 CCR § 912.7(b)(2), [932.7(b)(2), 952.7(b)(2)] shall be met.

(6) [Coast only] The post-harvest residual stand shall contain at least fifteen (15) square feet of Basal Area Per Acre of Seed Trees at least twelve (12) inches d.b.h. or greater for timber Sites I, II or III; or twelve (12) square feet of Basal Area Per Acre of Seed Trees twelve (12) inches d.b.h. or greater for timber Sites IV or V., except for timber sites I with coast redwood. For timber sites I with coast redwood, the post-harvest residual stand shall contain sufficient trees to meet at least the basal area, size and phenotypic quality of the leave tree requirements specified under the Seed Tree method (14 CCR § 913.1(c)(1)(A)). Unless obviously stocked, these basal area requirements will be determined from sampling averaged across each harvested area required in 14 CCR § 913.2(b)(1). Unless the plan submitter demonstrates how the proposed harvest will achieve MSP pursuant to 14 CCR § 913.11(a) or (b), where present in the preharvest stand, disease free, undamaged Seed Trees eighteen (18) inches d.b.h. or greater shall be retained post-harvest until the stand exceeds the minimum Seed Tree requirements of 14 CCR § 913.1(c)(1)(A). The Seed Trees shall be full crown, capable of seed production and representative of the best phenotypes available in the pre-harvest stand.

(6) [Northern, Southern] The post harvested residual stand shall contain at least fifteen (15) square feet of Basal Area Per Acre of Seed Trees at least twelve (12) inches d.b.h. or greater for timber Sites I, II or III; or twelve (12) square feet of Basal Area Per Acre of Seed Trees twelve (12) inches d.b.h. or

CALIFORNIA FOREST PRACTICE RULES

greater for timber Sites IV or V. Unless obviously stocked, these basal area requirements will be determined from sampling averaged across each harvested area required in 14 CCR § 933.2(b)(1)[953.2(b)(1)]. Unless the plan submitter demonstrates how the proposed harvest will achieve MSP pursuant to 14 CCR § 933.11(a) or (b) [953.11(a) or (b)], where present in the preharvest stand, disease free, undamaged Seed Trees eighteen (18) inches d.b.h. or greater shall be retained post-harvest until the stand exceeds the minimum Seed Tree requirements of 14 CCR § 933.1(c)(1)(A) [953.1(c)(1)(A)]. The Seed Trees shall be full crown, capable of seed production and representative of the best phenotypes available in the present stand.

(7) Following completion of Timber Operations (including Site Preparation) not more than twenty (20) percent of the Plan area harvested by this method shall be occupied by Small Group clearings.

(8) The Plan Submitter must provide the Director sufficient information such as growth and stand description to demonstrate that the standards of the selection Regeneration Method will be met by the third and subsequent entries of Plan areas harvested by the transition method.

(c) Within six (6) months following completion of Timber Operations conducted pursuant to the selection and transition methods as described in the Plan, a report of Stocking shall be filed as stated in PRC § 4587.

(d) In the absence of a Sustained Yield Plan, to maintain and improve tree Species diversity, genetic material, and seed production, trees of each native Commercial Species where present at the time of harvest shall be retained after harvest. These leave trees shall be representative of the best phenotypes available in the preharvest stand. The RPF may propose and the Director may agree to a species-specific plan in the THP which protects existing regeneration or provides for regeneration in-lieu of retaining trees.

913.3, 933.3, 953.3 Intermediate Treatments [All Districts, Note variations by District in (a)(1)(A), (a)(1)(B)]

(a) **Commercial thinning.** Commercial thinning is the removal of trees in a young-growth stand to maintain or increase average stand diameter of the residual crop trees, promote timber growth, and/or improve forest health. The residual stand shall consist primarily of healthy and vigorous dominant and codominant trees from the preharvest stand.

(1) Post harvest stand Stocking levels shall be stated in the THP. The level of residual Stocking shall be consistent with maximum sustained production of high quality timber products. Generally stands will develop stand structures with considerably higher levels of basal area than provided in these minimum standards as stand age increases. In no case shall Stocking be reduced below the following standards:

(A) Where the preharvest dominant and codominant crown Canopy is occupied primarily by trees greater than fourteen (14) inches d.b.h.:

[Coast]:

1. On Site I lands, at least one hundred twenty-five (125) sq. ft. per acre of basal area shall be left.
2. On Site II and III lands, at least one hundred (100) sq. ft. per acre of basal area shall be left.
3. On Site IV lands, at least seventy-five (75) sq. ft. per acre of basal area shall be left.
4. On Site V lands, at least fifty (50) sq. ft. per acre of basal area shall be left.

[Northern, Southern]:

1. On Site I mixed conifer lands, at least one hundred twenty-five (125) sq. ft. per acre of basal area shall be left, and on Site I land where greater than fifty (50) percent of the basal area is pine, at least one hundred (100) sq. ft. per acre of basal area shall be left.
2. On Site II mixed conifer lands, at least one hundred (100) sq. ft. per acre of basal area shall be left, and on Site II lands where greater than fifty (50) percent of the basal area is pine, at least seventy-five (75) sq. ft. per acre of basal area shall be left.
3. On Site III mixed conifer lands, at least seventy-five (75) sq. ft. per acre of basal area shall be left, and on Site III lands where greater than fifty (50) percent of the basal area is pine, at least seventy-five (75) sq. ft. per acre of basal area shall be left.
4. On Site IV and V mixed conifer lands, at least fifty (50) sq. ft. per acre of basal area shall be left, and on Site IV and V lands where greater than fifty (50) percent of the basal area is pine, at least fifty (50) sq. ft. per acre of basal area shall be left.

CALIFORNIA FOREST PRACTICE RULES

(B) [Coast] Where the preharvest dominant and codominant crown canopy is occupied primarily by trees less than fourteen (14) inches d.b.h., a minimum of one hundred (100) trees per acre over four (4) inches d.b.h. shall be retained.

(B) [Northern, Southern] Where the preharvest dominant and codominant crown Canopy is occupied primarily by trees less than fourteen (14) inches d.b.h., a minimum of sixty-five(65) trees per acre over four (4) inches d.b.h. shall be retained.

(2) Exceptions to these Stocking Standards may be proposed by the RPF when explained and justified in the plan, but in no case will the standards be below those specified in 14 CCR 912.7(b)(2) [932.7(b)(2), 952.7(b)(2)].

(3) For stands harvested in compliance with 14 CCR 913.3(a)(1)(A) [933.3(a)(1)(A), 953.3(a)(1)(A)] the trees to be harvested or the trees to be retained shall be Marked by or under the supervision of an RPF prior to felling operations. For all thinning proposals, a sample area must be Marked prior to a preharvest inspection for evaluation. The sample area shall include at least ten (10) percent of the thinning area up to a maximum of twenty (20) acres per stand type which is representative of the range of conditions present in the area. The Director may waive the Marking requirements for the remainder of the THP area when explained and justified in the THP.

(4) Within six (6) months following completion of Timber Operations as described in the plan, a report of stocking shall be filed as stated in PRC Section 4587.

(b) Sanitation-Salvage. Sanitation is the removal of insect attacked or diseased trees in order to maintain or improve the health of the stand. Salvage is the removal of only those trees which are dead, dying, or deteriorating, because of damage from fire, wind, insects, disease, flood, or other injurious agent. Salvage provides for the economic recovery of trees prior to a total loss of their wood product value. Sanitation and salvage may be combined into a single operation. The following requirements apply to the use of the sanitation-salvage treatment:

(1) The RPF shall estimate in the THP the expected level of stocking to be retained upon completion of Timber Operations.

(2) Immediately upon completion of Timber Operations, the area shall meet the stocking standards of 14 CCR 912.7(b) [932.7(b), 952.7(b)] unless explained and justified in the plan. If stocking is to be met immediately following completion of Timber Operations, a report of stocking shall be filed within 6 months of completion. If this standard cannot be met, the area must be planted during the first planting season following completion of Timber Operations and the minimum stocking standards of 14 CCR 912.7(b)(1) [932.7(b)(1), 952.7(b)(1)] must be met within five (5) years following completion of Timber Operations.

(3) Trees to be harvested or trees to be retained shall be Marked by or under the supervision of an RPF prior to felling operations. When openings greater than one-quarter (.25) acres will be created, the boundaries of the small group(s) may be designated in lieu of Marking individual trees within the small group areas. A sample area must be Marked prior to a preharvest inspection for evaluation. The sample area shall include at least ten (10) percent of the area, up to a maximum of twenty (20) acres per stand type, whichever is less, which is representative of the range of conditions present in the area. The Director may waive the Marking requirement for the remainder of the THP area when explained and justified in the THP.

913.4, 933.4, 953.4 Special Prescriptions

The following special harvesting methods are appropriate under certain conditions:

(a) Special Treatment Area Prescriptions. Special consideration in Special Treatment Areas shall be given to selection of a regeneration method or intermediate treatment compatible with the objectives for which the special area was established. Such areas shall be identified in the plan. To assure the integrity of legally designated historical and archaeological sites and legally designated ecological reserves, and that the objectives of the Special Treatment Areas are met, the RPF and the Director may agree, after on-the-ground inspection, if requested by either party, on specific silvicultural and logging practices to protect such areas. The Director shall notify affected agencies or groups with expertise in the resource involved in the Special Treatment Area of any such areas located during the THP review process.

(b) Rehabilitation of Understocked Area Prescription. Rehabilitation is a procedure for restoring and enhancing the productivity of commercial Timberlands which do not meet the Stocking Standards defined in 14 CCR 912.7 [932.7, 952.7] prior to any Timber Operations. On such lands, an area may be harvested

CALIFORNIA FOREST PRACTICE RULES

provided it is restocked in accordance with Subsections (1) or (2). To facilitate restocking, a regeneration Plan must be included in the THP. The regeneration plan shall include Site Preparation, method of regeneration, and other information appropriate to evaluate the plan.

(1) If the area meets the standards of 14 CCR 912.7 [932.7, 952.7] within five (5) years of completion of Timber Operations, the area shall be considered acceptably stocked, or shall be considered acceptably stocked if it contains at least ten (10) planted countable trees for each tree harvested on sites I, II, and III, and five (5) planted countable trees for each tree harvested on site IV and V.

(2) On understocked Timberlands where no countable conifer trees are to be harvested and the broadleaf species are not designated for management, the area shall be planted to equal or exceed the Stocking Standards of 14 CCR 912.7(b)(1) [932.7(b)(1), 952.7(b)(1)] and shall be considered acceptably stocked if within five (5) years of completion of Timber Operations it contains at least an average point count of one hundred (100) of Group A species on all site classifications.

(c) **Fuelbreak/Defensible Space.** Where some trees and other vegetation and fuels are removed to create or maintain a shaded fuel break or defensible space in an area to reduce the potential for wildfires and the damage they might cause. Minimum stocking standards within the timber operating area shall be met immediately after harvest and shall be those found in 14 CCR 912.7 [932.7, 952.7]. The RPF shall describe in the plan specific vegetation and fuels treatment, including timing, to reduce fuels to meet the objectives of the Community Fuelbreak area or other objectives identified by the RPF with the written concurrence of a public fire agency and determined by the Director to be consistent with the purposes of the Act.

(d) **Variable Retention.** Variable retention is an approach to harvesting based on the retention of structural elements or biological legacies (trees, snags, logs, etc.) from the pre-harvest stand for integration into the post-harvest stand to achieve various ecological, social and geomorphic objectives. The major variables in the variable retention harvest system are retention types, densities, and spatial arrangement of retained structures; aggregated retention is the retention of structures or biological legacies as intact forest patches within the harvest unit; dispersed retention is the retention of structures or biological legacies in a dispersed or uniform pattern. Retained trees may be intended to become part of future stands managed by the Selection regeneration method. Retained trees are often designated as decadent tree or snag recruitment hence not ever intended for harvest. Regeneration after harvest outside of aggregated retention patches may be obtained by direct seeding, planting, sprouting, or by natural seedfall.

(1) In the plan, the RPF shall describe in sufficient detail to provide for review and evaluation: the trees and elements retained, the objectives intended to be achieved by retention, the distribution and quantity of retained trees, the intended time period of retention, and any potential future conditions or events the RPF believes would allow harvest of retained trees. The RPF may explain and justify, and the Director may approve a plan which indicates up to 50% of retained trees are intended for harvest during future Intermediate Treatments of the regenerated portion of the harvest area where such harvest(s) are consistent with stated Variable Retention objectives.

(2) The retention standards for Dispersed Retention shall be measured in average Basal Area Per Acre. Where retention is aggregated in groups (greater than or equal to one-tenth acre), percentage of harvest unit area shall be the standard. Sum of all areas within groups divided by harvest unit acres will be used to determine percentage of aggregated retention in the harvest unit. Area and trees located within any standard width WLPZ will be excluded from calculating retention.

(3) The following retention standards shall be met:

(A) Minimum dispersed Variable Retention standard is 20 percent of the Resource Conservation Standards basal area levels stated in 14 CCR § 912.7 [932.7 952.7] (b) (2), 10 percent of harvest area in aggregated retention or combinations thereof. Variable Retention harvests at the minimum retention level shall be limited to 30 acres.

(B) Table 1 shall be used for Determining the Maximum Size Harvest Area for Variable Retention. For areas with a combination of dispersed and aggregated retention types for determination of permissible unit size, the percentage of basal area in dispersed retention portions of the combination area may be reduced proportionately to the area in aggregated retention indicated in Table 1.

Table 1

CALIFORNIA FOREST PRACTICE RULES

<i>Dispersed Retention</i>	<i>Aggregated Retention</i>	<i>Maximum Size Harvest Area</i>
>20% of 912.7 [932.7, 952.7](b)(2)	>10% Area	30 Acres
>30% of 912.7 [932.7, 952.7](b)(2)	>15% Area	40 Acres
>35% of 912.7 [932.7, 952.7](b)(2)	>20% Area	60 Acres
>45% of 912.7 [932.7, 952.7](b)(2)	>25% Area	80 Acres
>55% of 912.7 [932.7, 952.7](b)(2)	>30% Area	120 Acres
>75% of 912.7 [932.7, 952.7](b)(2)	>40% Area	200 Acres

(C) Aggregated retention areas that conform to the definition of Late Succession Forest Stands under 14 CCR § 895.1, with the exception of the minimum 20 acre threshold size, may be counted as contributing 1.5 times the acres they actually occupy toward providing retention.

(D) Retention trees classified as Dunning’s Class 3, 4, 5, or 7 which exceed the size standards of 14 CCR § 912.7 [932.7, 952.7] may be counted as contributing 1.5 times their actual basal area toward providing retention.

(E) Retention standards shall be met on each 20-acre maximum area(s) within each harvest unit. Retention standards may be met by either dispersed, aggregated or a combination of the two types of retention.

(F) Unless explained and justified by the RPF in the plan, and approved by the Director, no point within the harvest area where retention standards are met by dispersed retention shall be more than 300 feet from a retention tree.

(G) With the exception of 14 CCR § 913.4 [933.4, 953.4] (d)(3)(J) below, the average height of dispersed retention trees shall be at least the average height of dominants and codominants of like species in the pre-harvest stand.

(H) For areas where the plan relies on natural seedfall to obtain regeneration, dispersed retention trees shall meet the standards of 14 CCR § 913.1 [933.1, 953.1](c)(1). Where retention is aggregated, retained aggregates shall meet the standards of Commercial Thinning required under 14 CCR § 913.3 [933.3, 953.3](a) including (a)(1)(A) or (a)(1)(B).

(I) Where specific WHR habitat elements are insufficient to provide functional wildlife habitat, the RPF may explain and justify and the Director may approve alternatives to the standards of subsections 14 CCR § 913.4 [933.4, 953.4](d)(3)(G) and (H).

(J) Decadent and Deformed Trees of Value to Wildlife, and Snags which meet the standards of 14 CCR § 912.7 [932.7, 952.7](b)(3)(A,B or C) and 14 CCR § 912.7 [932.7, 952.7](c) may be counted to meet up to 15 square feet of Basal Area Per Acre of retention in excess of the minimum variable retention standards (ref. 14 CCR § 913.4 [933.4, 953.4](d)(3)(A)).

(K) Trees shall be retained for at least 50 years unless a shorter period of time is described in the plan, explained and justified by the RPF, and approved by the Director.

(4) Retention standards shall be met immediately after harvest and if retention trees are to be used to meet stocking, at the time the stocking report is approved.

(5) The stocking standards of 14 CCR § 912.7 [932.7, 952.7](b)(1) shall be met within five years following completion of operations.

(6) Retention trees shall be protected to the extent feasible during Timber Operations consistent with 14 CCR §§ 914.1 [934.1, 954.1]; 914.2 [934.2, 954.2](e); 914.3 [934.3, 954.3]; 915.2 [935.2,955.2]; 915.3 [935.3, 955.3] and 917.7[937.7, 957.7].

(7) The plan shall indicate the estimated average pre-harvest and post-harvest basal area by species

CALIFORNIA FOREST PRACTICE RULES

and diameter class. Diameter class designations shall be grouped in no greater than 6" classes.

(8) Where retention is aggregated in groups, the RPF shall provide in the plan a general description of group locations and/or a map showing the approximate location of the groups. This information shall be provided for each logging unit.

(9) All trees to be harvested or all retention trees shall be marked by, or under the supervision of, an RPF prior to felling operations. Where timber harvesting does not occur within retained aggregates, the boundaries of retained aggregates may be designated in lieu of marking individual trees within retained aggregates. A sample area must be marked prior to a pre-harvest inspection for evaluation. The sample area shall include at least 10% of the harvest area for each stand type represented in the range of conditions present in the area. Where necessary to evaluate the proposed retention, the Director may require additional marking before plan approval.

(10) To facilitate restocking, a regeneration plan must be included in the plan. The regeneration plan shall include Site Preparation, method of regeneration, and other information appropriate to evaluate the plan. Site Preparation activities shall be designed to protect retention elements and maintain ground cover to the extent practicable while at the same time result in seedling establishment on the site and encourage long-term site occupancy of the regenerated trees.

(11) Another Variable Retention harvest may not be applied to the Variable Retention harvest area for at least 50 years for Class I, 60 years for Class II or III, or 80 years for Class IV and V site class lands after acceptance by the Director of the completion report except as specified in: (i) a THP that has been approved pursuant to 14 CCR § 913.11 [933.11, 953.11](a), (ii) an SYP, (iii) a PTEIR or, (iv) an NTMP).

(12) Within ownership boundaries, no logical logging unit contiguous to a previously harvested Variable Retention harvest area may be harvested by a Variable Retention method unless the previously harvested Variable Retention unit has an approved report of stocking and the dominant and codominant trees, not counting retention trees, average at least five years of age or average at least five feet tall and three years of age from the time of establishment on the site either by the planting or by natural regeneration. If these standards are to be met with trees that were present at the time of the harvest, there shall be an interval of not less than five years following the completion of operations before adjacent Variable Retention management may occur.

(13) A Regeneration Method Used in Evenaged Management, other than Shelterwood Preparatory Step, may not be applied to the Variable Retention harvest area for at least 50 years for Class I, 60 years for Class II or III, or 80 years for Class IV and V site class lands after acceptance by the Director of the completion report.

(14) Within an ownership, at least 10 years must pass after a Variable Retention harvest that exceeds the size standards of 14 CCR § 913.1 [933.1, 953.1] (a)(2) before a Regeneration Method Used in Evenaged Management, other than Shelterwood Preparatory Step, may occur in an adjacent logical harvest area.

(15) Within an ownership, the separation requirements and adjacency limitations of 14 CCR § 913.1 [933.1, 953.1](a)(3, 6 and 7) shall apply equally to Variable Retention harvest areas and evenaged regeneration units.

(16) Alternative Prescriptions proposed under 14 CCR § 913.6 [933.6, 953.6] may not reference Variable Retention as the most nearly feasible method (ref. 14 CCR § 913.6 [933.6, 953.6](b)(3 and 4)). Alternative Prescriptions which approach but do not fully meet the minimum standards of Variable Retention shall be considered Alternatives to a Regeneration Method Used in Evenaged Management.

(e) Aspen, and Meadows and Wet Areas restoration. All trees within aspen stands (defined as a location with the presence of living aspen (*Populus tremuloides*), Meadows and Wet Areas may be harvested or otherwise treated in order to restore, retain, or enhance these areas for ecological or range values. A primary goal of aspen restoration Projects is the successful regeneration of aspen and recruitment into larger size classes. Projects using this prescription shall be designed to balance the protection and regeneration of aspen stands, Meadows and Wet Area habitats in California's forest ecosystems with the other goals of forest management as specified in 14 CCR § 897 and meet the following requirements:

(1) The RPF shall state in the plan each project type(s) that is being proposed (aspen, or Meadows and Wet Areas restoration).

(2) Each project type shall be shown on the plan map, consistent with 14 CCR § 1034(x), and at a scale that shows the locations of planned operations.

CALIFORNIA FOREST PRACTICE RULES

(3) The RPF shall describe the extent of the area proposed for harvesting or treatment and the types of harvesting or treatments.

(4) The RPF shall describe the condition of aspen stands, and Meadows and Wet Areas in the project area.

(A) For aspen stands, the condition description shall include, but is not limited to, the determination of whether the aspen stands are upland aspen stands or Riparian aspen stands; spatial extent, species composition, and stand structure (including overstory/understory coverage and whether a stand is pure aspen or mixed with conifer) of the project area; and the relationship of the project area to other known aspen stands in the planning watershed or biological assessment area.

(B) For Meadows and Wet Areas, the condition description shall include spatial extent, species composition, and stand structure (including overstory/understory coverage) of the project area; relevant Watercourse condition factors stated in Board Technical Rule Addendum #2; and other factors indicative of Meadows and Wet Area geomorphic and hydrological functions.

(5) The RPF shall state the project goals and the measures of success for the proposed aspen, meadow, or wet area restoration project. For purposes of this subsection, measures of success means criteria related to a physical condition that can be measured using conventional forestry equipment or readily available technology to indicate the level of accomplishment of the project goals.

(A) Aspen, or Meadows and Wet Areas project goals and measures of success shall be based on the condition assessment required in 14 CCR §§ 913.4, 933.4, and 953.4, subsection (e)(4), and identification of problematic aspen, Meadows and Wet Areas conditions and their agents/causes. Information shall include a description of factors that may be putting aspen stands, or Meadows and Wet Areas at risk, and presence of any unique physical conditions. Projects shall be designed to contribute to rectifying factors that are limiting restoration, to the extent feasible.

(6) For Projects of twenty (20) acres or less in size, the RPF has the option to not include the requirements of 14 CCR §§ 913.4, 933.4, and 953.4, subsections (e)(4) and (5) if the RPF consults with CDFW prior to plan submittal and, if wet areas are proposed, the RPF shall also consult with the appropriate RWQCB in those locations where the applicable basin plan identifies wet areas as a beneficial use. The results of the consultation(s) shall be included in the plan,

(7) The Department shall review post-harvest field conditions of the portions of plans using the aspen, Meadows and Wet Areas restoration silvicultural prescription and prepare a monitoring report every five (5) years for the Board. The monitoring report shall summarize information on use of the prescription including:

(i) The level of achievement of the measures of success as stated in the plan per 14 CCR §§ 913.4, 933.4, and 953.4, subsection (e)(5);

(ii) Any post-harvest adverse environmental Impacts resulting from use of the prescription;

(iii) Any regulatory compliance issues; and

(iv) Any other significant findings resulting from the review. The review shall include photo point records.

(8) Exemptions from other FPRs:

(A) Silvicultural standards for opening size, adjacency requirements, or conifer stocking standards in 14 CCR §§ 913.1-913.3, 933.1-933.3, and 953.1-953.3]; 14 CCR §§ 913.6, 933.6, and 953.6; and 14 CCR § 913.8 do not apply to use of this prescription.

(B) Minimum resource conservation standards in 14 CCR §§ 912.7, 932.7, and 952.7 do not apply to use of this prescription.

(C) For purposes of this prescription, Timberland productivity and MSP requirements as stated in 14 CCR §§ 913.10, 933.10, and 953.10; and 14 CCR §§ 913.11, 933.11, and 953.11 are compatible with implementing actions that contribute to attaining the measures of success approved by the Department for this prescription.

[913.4, 933.4] (f) White and Black Oak Woodland Management. Timber harvest within certain deciduous oak woodlands, forests, and savannahs as described herein may occur as necessary to restore or conserve the ecological, cultural, and economic values of these historically oak-dominated stands. The silviculture shall be designed to reduce water, light, and nutrient competition from Group A species in order to promote the sustained viability of Oregon white oak and California black oak stands. Group B species

CALIFORNIA FOREST PRACTICE RULES

including white and black oaks may also be harvested. The use of this prescription shall be designed to balance the contribution of resource values attributable to Oregon white oak and California black oak stands with the other goals of forest management specified in 14 CCR § 897, and shall meet the following requirements:

(1) The prescription may be applied to stands in which Oregon white oak (*Quercus garryana*) and/or California black oak (*Quercus kelloggii*) meet or exceed, preharvest, an average of 35 square feet of Basal Area Per Acre.

(2) The RPF shall provide a description of the stand for which the special prescription is to be applied including:

(A) An estimate, by species, of pre-harvest stand composition, diameter distribution, and basal area.

(B) A description of natural and any known anthropogenic factors conducive to Oregon white oak and/or California black oak historic and sustained occupancy of the site. This may include discussion of climate, soil, light, aspect, fire regime, management practices, or other relevant factors.

(C) A description of any apparent or known trend in changing stand composition occurring over time and the factors likely to be contributing to this trend.

(3) The RPF shall provide a description of the planned post-harvest stand condition including, by species, desired stand composition, diameter distribution, and basal area.

(4) The RPF shall describe what trees are to be harvested and the method by which those trees shall be identified, as well as any special instructions to the LTO regarding measures to be taken to protect residual oak trees during Timber Operations. If trees are to be identified by the method of marking, they shall be marked by, or under the supervision of, an RPF prior to harvest. A sample area must be marked prior to the preharvest inspection for evaluation. The sample area shall include at least 10% of the harvest area to a maximum of 10 acres per stand type which is representative of the range of conditions present in the area. The Director may waive the requirements for the remainder of the area when explained and justified by the RPF in the THP.

(5) The RPF shall describe how the boundaries of the special prescription shall be identified and, prior to the preharvest inspection, the special prescription boundaries shall be identified on the ground, under the supervision of an RPF.

(6) Decadent and Deformed Trees of Value to Wildlife shall be retained unless they pose a safety hazard or explanation and justification is provided by the RPF as to why removal is necessary to facilitate Timber Operations or the objectives of the harvest or special prescription.

(7) Immediately upon completion of Timber Operations, the post-harvest stand shall contain Oregon white oak and/or California black oak stocking levels that meet or exceed an average of 35 square feet of Basal Area Per Acre.

(8) Immediately upon completion of Timber Operations, Group A species shall not exceed 50 percent of the combined Group A and B species post-harvest stand basal area. Oregon white oak and/or California Black oak stocking levels shall not be reduced proportionally relative to Group A species as a result of the harvest.

913.5, 933.5, 953.5 Stocking Status

Under any regeneration method where artificial regeneration is specified in the plan to restock the logged area, a preliminary report on the degree of stocking shall be submitted to the Director annually, between October 1 and December 31, beginning two years following completion of logging by the Timber Owner or his/her agent until the stocking standard of 14 CCR 912.7 [932.7, 952.7] is met or exceeded or as otherwise required. This report shall indicate the degree of stocking achieved and any additional measures that will be taken to stock the logged area.

913.6, 933.6, 953.6 Alternative Prescriptions [All Districts]

(a) An alternative prescription shall be included in a THP when, in the judgment of the RPF, an alternative regeneration method or intermediate treatment offers a more effective or more feasible way of achieving the objectives of Section 913 [933, 953] than any of the standard silvicultural methods provided in this Article.

(b) An alternative prescription, as defined in 14 CCR 895.1, shall normally contain at least the following

CALIFORNIA FOREST PRACTICE RULES

information:

- (1)** A description of the stand before Timber Operations, including:
 - (A)** The RPF's professional judgment of the species composition of the stand before harvest.
 - (B)** The RPF's professional judgment of the current stocking on the area expressed in basal area or a combination of basal area and point count.
 - (C)** The RPF's estimate of the Basal Area Per Acre to be removed from the stand during harvest.
- (2)** A description of stand management constraints such as animal, insect, disease, or other natural damage, competing vegetation, harsh site conditions, or other problems which may affect stand management.
- (3)** A statement of which silvicultural method in the current District Rules is most nearly appropriate or feasible and an explanation of why it is not appropriate or feasible.
- (4)** An explanation of how the proposed alternative prescription will differ from the most nearly feasible method in terms of securing regeneration; protection of soil, water quality, wildlife habitat, and visual appearance; and in terms of fire, insect and disease protection.
- (5)** A description of the stand expected after completion of Timber Operations, including the following:
 - (A)** The management objective under which the post-harvest stand is to be managed (evenaged, unevenaged, or neither);
 - (B)** The desired tree species composition of the post-harvest stand and the RPF's judgment as to the remaining stocking after harvest expressed as basal area or a combination of basal area and point count.
- (6)** The treatment of the stand to be used in harvesting including:
 - (A)** The guidelines to be used in determining which trees are to be harvested or left;
 - (B)** The type of field designation to be followed, such as marking, sample marking of at least 20 percent of the trees to be harvested or left, professional supervision of fallers or other methods; and
 - (C)** The Site Preparation and regeneration method and timetable to be used for restocking.
- (c)** If an alternative prescription will have the practical on-the-ground effect of a clearcut, regardless of name or description, then the acreage limitations, and requirement for separation by a typical logging unit, Yarding equipment limitations, exceptions, and stocking requirements for the clearcut regeneration method shall apply.
- (d)** All trees to be harvested or all trees to be retained shall be marked by, or under the supervision of, an RPF prior to harvest. A sample area must be marked prior to the preharvest inspection for evaluation. The sample area shall include at least 10% of the harvest area to a maximum of 20 acres per stand type which is representative of the range of conditions present in the area. The Director may waive the requirements for the remainder of the area when explained and justified by the RPF in the THP.
- (e)** The Director shall approve the alternative if in his judgment it complies with 14 CCR 898 and if, considering the entire area to which the alternative is to be applied, it would:
 - (1)** When compared with the standard method identified in subsection (b)(3) above have an effect equal to or more favorable than such standard method would achieve in the areas of values relating to soil, the quality and beneficial uses of water, wildlife and fisheries,
 - (2)** Not create a significant adverse change in range and forage, and recreation and aesthetic values; and
 - (3)** Not reduce the after harvest stocking standards or evenaged prescription limitation below the most closely associated standard, unless the RPF demonstrates that either:
 - (A)** The harvest will result in stand conditions that will increase long term sustained yield as compared to the long term sustained yield achieved by utilizing the stocking standards of the method identified in subsection (b)(3); or
 - (B)** The yield over 20 years of a "No Harvest" alternative would be less than the yield over 20 years of the proposed alternative.
 - (4)** Not lead to the direct or indirect conversion of the Timberland to other land uses not associated with timber growing and harvesting and compatible uses unless a Timberland Conversion Permit is approved before submission of the THP; and
 - (5)** Not result in violations of any of the other standards in the Rules of the Board.

CALIFORNIA FOREST PRACTICE RULES

913.7, 933.7 Exceptions [Coast, Northern]

The requirements of this article shall not prohibit the Timber Operator from cutting or removing trees for the purposes of:

- (a) Clearing rights-of-way, log Landings, campsites, or firebreaks necessary for the conduct of Timber Operations.
- (b) The harvesting of Christmas trees and construction of a public fire protection agency fuel break is also permitted.

953.7 Riparian Vegetation [Southern]

All noncommercial Riparian vegetation found along Streams and lakes and within Meadows and Wet Areas shall be retained and protected insofar as practical.

953.8 Exceptions [Southern]

The requirements of this article shall not prohibit the operator from cutting or removing trees for purposes of clearing rights-of-way, log Landings, campsites, or firebreaks necessary for the conduct of Timber Operations. The harvesting of Christmas trees and construction of a public fire protection agency fuelbreak is also permitted.

913.8 Special Harvesting Methods for Southern Subdistrict [Coast]

(a) Only the following Regeneration Methods and Stocking requirements, and those described in Article 6 of Subchapter 7 of this Chapter, shall apply in the Southern Subdistrict of the Coast Forest District. Timber Operations shall be conducted in accordance with paragraphs (1), (2), or (3) below. If the provisions of more than one subsection will be used within any individual timber operation or Logging Area, a line separating the areas to be cut under provisions of each shall be shown in the Plan and clearly defined on the ground by paint or other means prior to filing the Plan and so as to be readily identifiable during and after completion of logging.

(1) Leave uncut a well-distributed timber stand after Timber Operations have been completed on the Logging Area that is at least forty (40) percent by number of those trees eighteen (18) inches and more d.b.h. present prior to commencement of current Timber Operations. Leave trees shall be thrifty coniferous trees which were dominant or co-dominant in crown class prior to timber harvesting or which have crowns typical of such dominant or co-dominant trees. They shall be free from significant damage caused by the Timber Operations. No conifer shall be cut which is more than seventy-five (75) feet from the nearest leave tree twelve (12) inches d.b.h. or larger located within the Logging Area. No area may be cut in excess of the leave tree standards of this rule in any ten (10) year period. Upon completion of Timber Operations one of the following Stocking Standards for coniferous trees shall be met:

(A) Basal Area. The average residual basal area, measured in stems one (1) inch or larger in Diameter at least one hundred twenty (120) square feet per acre on Site I lands, and at least one hundred (100) square feet per acre on Site II lands, and seventy-five (75) square feet per acre on Site III lands, and fifty (50) square feet per acre on Sites IV and V lands.

(B) Countable Trees. The area contains a well-distributed stand of trees with an average Countable Tree point count of at least two hundred (200) per acre on Site I and II lands, one hundred twenty-five (125) per acre on Site III lands, or one hundred (100) per acre on Site IV and V lands. The point count to be computed as:

1. Each Countable Tree which is not more than four (4) inches d.b.h. counts one (1) point.
2. Each Countable Tree over four (4) inches and not more than twelve (12) inches d.b.h. counts two (2) points.
3. Each Countable Tree over twelve (12) inches d.b.h. counts as four (4) points.
4. Redwood root crown sprouts over one (1) foot in height will be counted using the average stump diameter one (1) foot above average ground level of the original stump from which the redwood root crown sprouts originate counting one (1) sprout for each one (1) foot of stump diameter to a maximum of six (6) per stump. Any countable redwood root crown sprout over one (1) foot in height but less

CALIFORNIA FOREST PRACTICE RULES

than four (4) inches d.b.h. shall count as one (1) toward meeting Stocking requirements.

(2) An alternative Regeneration Method may be approved only if all of the following are met:

(A) The Regeneration Method described in subsection (a) above is not silviculturally appropriate or Feasible in the professional judgment of the Director and the RPF who prepared the Plan.

(B) Cutting Methods prescribed under the provisions of this section must maintain a well-distributed tree crown cover of at least fifty (50) percent of the pre-existing tree crown Canopy. At no time shall the crown cover be reduced to a level where the productivity of the land is jeopardized or to a level which would create a threat to soil and/or water resources. Provided the required crown cover can be maintained, the removal of all trees in Small Groups not exceeding one-half (0.5) acre in size may be approved as part of the overall cutting prescription.

(C) The alternative method shall provide overall protection at least equal to that of the standard provided by subsection (a) for watershed, wildlife, soil, and aesthetic resources considering the Silvicultural Method, conditions necessary for regeneration, tree growth rate, annual rainfall, summer temperature and length of dry season, critical problems of erodible soils, Unstable Areas, need for high water quality, increased fire potential, and exposure to more intensive use.

(D) A Plan agreed upon between the RPF and the Director is prepared which gives timber stand information concerning Stocking levels, cutting goals, timber stand growth and future harvest timing expectations.

(E) The Timber Operator is responsible for carrying out Timber Operations as described in the Plan. The Plan submitter is responsible for retaining an RPF to provide professional advice to the Timber Operator and Timberlands owner on a continuing basis throughout the Timber Operations. The RPF or the designee of the RPF works closely with the Timber Operator to help assure compliance with the approved Alternative Prescription and the terms and specifications of the approved Plan. The RPF or the designee of the RPF is present on the Harvest Area sufficient hours each week to know the operations' progress and advise the Timber Operator. The RPF informs the Timber Operator of potential environmental impacts and the mitigation measures to be taken to minimize such impacts. The Timber Operator shall sign the Plan and major amendments thereto, or shall sign and file with the Director a facsimile thereof, prior to commencement or continuation of operation thereunder agreeing to abide by the terms and specifications of the Plan. An RPF may be responsible for the conduct of Timber Operations under contractual arrangements with the Timber Owner.

(F) The Logging Area shall meet the Stocking Standards described in 14 CCR § 913.8(a)(1) within five (5) years following completion of Timber Operations.

(G) Group B species designated for management may be counted for Stocking, consistent with 14 CCR § 912.7(d).

(3) The harvest of dead, Dying or deteriorating trees resulting from fire, wind, insect, disease, flood, or other injurious agents as provided in 14 CCR § 913.3(b) shall be exempt from 14 CCR § 913.8(a)(1) and (2) except for Stocking under 14 CCR § 913.8(a)(2) provided there has been a preharvest inspection and a Plan has been approved.

953.9 Successive Cutting [Southern only]

Relogging of an area in less than the period of five years required for meeting stocking standards can be done only under either of the following conditions: (a) Sanitation-salvage cuttings, or (b) When stocking requirements have been met and a report of satisfactory stocking (ref. 14 CCR § [1075) has been issued by the Director.

913.10, 933.10, 953.10 Timberland Productivity, Sustained Forestry Planning, Addendum

The goal of this section is to restore, enhance and maintain the productivity of the state's Timberlands, where feasible.

(a) Where feasible, the productivity of Timberlands shall be maintained on a site-specific basis by

1) Meeting the stocking standards of the selected silvicultural or regeneration method, or that level of stocking above the minimum that will achieve long term sustained yield (LTSY) that is proposed in 913.11 a or b.

2) Proposing and implementing an appropriate silvicultural system and regeneration method for the

CALIFORNIA FOREST PRACTICE RULES

site,

3) Protecting the soil resource and its ability to grow commercial tree species and provide sustainable associated forest values.

(b) Timberland productivity is restored by mitigating the adverse effects of catastrophic events or previous land use activities in order to improve the site capacity to grow for harvest commercial tree species and provide forest values.

(c) Timberland productivity is enhanced by such means as planting, thinning, stand manipulation, Stream channel improvement, or other techniques that will lead to increased tree growth and yield, accumulation of growing stock and production of associated forest values.

(d) Measures implemented to mitigate or avoid adverse environmental Impacts of timber harvesting contribute to restoration and enhancement of Timberland productivity. Plan submitters are encouraged, but not required, to undertake additional measures to restore and enhance Timberland productivity. CAL FIRE may advise plan submitters of measures which could be undertaken at the plan submitters' option to further restore and enhance Timberland productivity.

(e) This section does not impose any additional obligation on owners of Timberlands where wildfires, insects, disease, wind, flood, or other blight caused by an act of nature reduces stocking levels below any applicable stocking requirements.

913.11, 933.11, 953.11 Maximum Sustained Production of High Quality Timber Products

The goal of this section is to achieve Maximum Sustained Production of High Quality Timber Products (MSP). MSP is achieved by meeting the requirements of either (a) or (b) or (c) in a THP, SYP, NTMP, or WFMP, or as otherwise provided in Article 6.8, Subchapter 7, Subchapter 7, Chapter 4, Division 1.5, Title 14 of the California Code of Regulations.

(a) Where a Sustained Yield Plan (14 CCR § 1091.1) or NTMP, or a WFMP has not been approved for an ownership, MSP will be achieved by:

(1) Producing the yield of timber products specified by the landowner, taking into account biologic and economic factors, including factors related to fire risk, while accounting for limits on productivity due to constraints imposed from consideration of other forest values, including but not limited to, recreation, watershed, wildlife, fire protection, range and forage, fisheries, regional economic vitality, employment and aesthetic enjoyment.

(2) Balancing growth and harvest over time, as explained in the THP for an ownership, within an assessment area set by the Timber Owner or Timberland Owner and agreed to by the Director. For purposes of this subsection the sufficiency of information necessary to demonstrate the balance of growth and harvest over time for the assessment area shall be guided by the principles of practicality and reasonableness in light of the size of the ownership and the time since adoption of this section using the best information available. The projected inventory resulting from harvesting over time shall be capable of sustaining the average annual yield achieved during the last decade of the planning horizon. The average annual projected yield over any rolling 10-year period, or over appropriately longer time periods for ownerships which project harvesting at intervals less frequently than once every ten years, shall not exceed the projected long-term sustained yield.

(3) Realizing growth potential as measured by adequate site occupancy by species to be managed and maintained given silvicultural methods selected by the landowner.

(4) Maintaining good stand vigor.

(5) Making provisions for adequate regeneration. At the plan submitter's option, a THP may demonstrate achievement of MSP pursuant to the criteria established in (b) where an SYP has been submitted but not approved.

(b) Where a SYP, NTMP, or WFMP is submitted for an ownership, an approved SYP, NTMP, or WFMP achieves MSP by providing sustainable harvest yields established by the landowner which will support the production level of those high quality timber products the landowner selects while at the same time:

(1) meeting minimal stocking and basal area standards for the selected silvicultural methods as provided in these Rules as described;

(2) protecting the soil, air, fish and wildlife, water resources and any other public trust resources;

(3) giving consideration to fire risk, fire protection, recreation, range and forage, regional economic vitality, employment and aesthetic enjoyment;

CALIFORNIA FOREST PRACTICE RULES

(4) balancing growth and harvest over time. The projected inventory resulting from harvesting over time shall be capable of sustaining the average annual yield achieved during the last decade of the planning horizon. The average annual projected yield over any rolling 10-year period, or over appropriately longer time periods for ownerships which project harvesting at intervals less frequently than once every ten years, shall not exceed the projected long-term sustained yield. A THP which relies upon and is found to be consistent with an approved SYP shall be deemed adequate to achieve MSP.

(c) In a THP, NTMP, or WFMP, MSP is achieved by:

(1) For evenage management, meeting the minimum stand age standards of 14 CCR § 913.1(a)(1), meeting minimum stocking and basal area standards for the selected silvicultural methods as contained in these Rules only with group A species, and protecting the soil, air, fish and wildlife, water resources and other public trust resources through the application of these Rules; or

(2) For unevenaged management, meeting minimum stocking and basal area standards for the selected silvicultural methods as contained in these Rules, and protecting the soil, air, fish and wildlife, water resources and other public trust resources through the application of these Rules.

(3) For intermediate treatments and special prescriptions, complying with the stocking requirements of the individual treatment or prescription.

(4) Timberland ownerships totaling 50,000 acres or less may use subsection (c) to show MSP.

(5) Timberland ownerships of 50,000 acres or more may use subsection (c) through December 31, 1999. Thereafter they may use subsection (c) if an SYP or demonstration of achievement of MSP pursuant to 14 CCR § 913.11(a) [933.11(a), 953.11(a)] has been filed with the department and has not been returned unfiled or approved.

(6) For scattered parcels on Timberland ownerships of 50,000 acres or more, subsection (c) may be used to show MSP.

953.12 High Use Subdistrict

In the "high use subdistrict," the selection regeneration method, or sanitation-salvage or commercial thinning treatments may be used. An RPF may propose a modification of the selection regeneration method or sanitation-salvage intermediate treatments when explained and justified in the plan (see 14 CCR 953 for alternative prescriptions). In these areas, no trees shall be cut unless first marked on both the bole and stump with either paint, tags or blazes so as to be plainly visible. Such marking shall be done by an RPF or supervised designee sufficiently in advance of cutting to allow for inspection by the Director's representatives. In these areas, the leave stand will be at least 50% of the number of trees 30.5 cm (12 in.) or larger d.b.h. standing prior to the time of harvesting. These leave trees should be in Dunning's tree classes 1, 2, or 3 (Ref. 14 CCR 952 def. Dunning's classification). The composition and distribution of the leave stand shall be maintained as nearly as practical, giving consideration to the esthetics of the areas.

Article 4 Harvesting Practices and Erosion Control

914, 934, 954 Purposes [All Districts]

Timber Operations shall be conducted to: meet the goal of maximum sustained production of high quality timber products; minimize breakage of merchantable timber; prevent unreasonable damage to residual trees, Reproduction, and fish and wildlife habitat as identified in the Plan, or contained in the Rules; prevent degradation of the quality and Beneficial Uses of water consistent with 14 CCR § 916.2[936.2,956.2]; prevent degradation of the Beneficial Functions of Riparian Zones consistent with 14 CCR § 916.2[936.2,956.2]; and maintain site productivity by minimizing disturbance that could lead to soil loss.

914.1, 934.1, 954.1 Felling Practices [All Districts]

The following standards are applicable to felling practices:

(a) To the fullest extent possible and with due consideration given to topography, lean of trees, Landings, utility lines, local obstructions, and safety factors, trees shall be felled to lead in a direction away from Watercourses and lakes.

(b) Desirable residual trees and tree seedlings of commercial species, and the oak trees requiring protection pursuant to 14 CCR § 953.10 shall not be damaged or destroyed by felling operations, except

CALIFORNIA FOREST PRACTICE RULES

where unavoidable due to safety factors, lean of trees, location of obstructions or roads, or lack of sufficient openings to accommodate felled trees.

(c) Trees shall be felled in conformance with Watercourse and lake protection measures incorporated in timber harvesting plans and consistent with Article 6 of these Rules.

(d) Felling practices shall conform to requirements of 14 CCR §§ 919.2, 939.2, 959.2 to protect bird nesting sites.

914.2, 934.2, 954.2 Operations [All Districts]

(a) Timber Operations shall be conducted in a manner which complies with 14 CCR § 914 [934, 954].

(b) Heavy equipment which is equipped with a blade, shall not operate on skid roads or slopes that are so steep as to require the use of the blade for braking.

(c) Tractor Roads shall be limited in number and width to the minimum necessary for removal of logs.

(d) Heavy equipment shall not operate on Unstable Areas. If such areas are unavoidable, the RPF shall develop specific measures to minimize the effect of operations on slope instability. These measures shall be explained and justified in the plan and must meet the requirements of 14 CCR § 914 [934, 954].

(e) Slash and debris from Timber Operations shall not be bunched adjacent to residual trees required for silvicultural or wildlife purposes, or placed in locations where they could be discharged into a Class I or II Watercourse, or Lake.

(f) The following limitations apply:

(1) Except for Tethered Operations, heavy equipment shall be prohibited where any of the following conditions are present:

(A) Slopes steeper than 65%.

(B) Slopes steeper than 50% where the Erosion Hazard Rating is high or extreme.

(2) Heavy equipment shall be prohibited on slopes over 50% which lead without flattening to sufficiently dissipate water flow and trap sediment before it reaches a Watercourse or Lake.

(3) On slopes between fifty (50) percent and sixty-five (65) percent where the Erosion Hazard Rating is moderate, and all slope percentages are for Average Slope steepness based on sample areas that are twenty (20) acres, or less if proposed by the RPF or required by the Director, heavy equipment, except for Tethered Operations, shall be limited to:

(A) Existing Tractor Roads that do not require reconstruction, or

(B) New Tractor Roads at a location that has been shown on the Plan map, flagged by an RPF or supervised designee prior to the pre-harvest inspection or, when a pre-harvest inspection is not required, prior to the start of Timber Operations, and approved by the Director.

(4) Non-Tethered Tractor Operations, excluding Yarding, may occur in areas designated for Cable Yarding on slopes up to 50%. Tethered Operations, excluding Yarding, may occur in areas designated for Cable Yarding. The limitations of 14 CCR § 914.2[934.2, 954.2](a), (b), (c), (d), (e), (f)(2), (g), (h), and (i), and any other applicable limitations on Tractor Operations throughout this Chapter, by District, apply.

(5) The RPF may propose exceptions to the limitations on Tractor Operations described above if the proposed exception will comply with 14 CCR § 914 [934, 954], and if the Plan both clearly explains the proposed exception and justifies how the proposed exception will comply with 14 CCR § 914 [934, 954]. The location of Tractor Roads, except for those used in Tethered Operations, to be used under such exceptions shall be flagged prior to the pre-harvest inspection or, when a pre-harvest inspection is not required, prior to the start of Timber Operations.

(g) Where tractor roads are constructed, Timber Operators shall use tractor roads only, both for Skidding logs to Landings and on return trips.

(h) Timber Operators shall exercise due diligence so that desirable residual trees and seedlings which are required to be retained upon completion of Timber Operations will not be damaged or destroyed by Timber Operations.

(i) Where Waterbreaks cannot effectively disperse surface runoff, other Erosion Controls shall be installed as needed.

914.3, 934.3, 954.3 Cable Yarding [All Districts]

The following standards are applicable to Cable Yarding:

CALIFORNIA FOREST PRACTICE RULES

- (a) Due diligence shall be exercised in the installing, and operating, of cable lines so that residual trees will not incur unreasonable damage by such installation or use.
- (b) Residual trees required to be left upon completion of Timber Operations shall not be used for rub trees, corner blocks, rigging or other cable ties unless effectively protected from damage.
- (c) The practice of tight-lining for the purpose of changing location of cable lines is prohibited unless such practice can be carried on without damaging residual trees.
- (d) Cable Yarding settings shall take maximum advantage of the natural topography and timber types so that Yarding operations will protect residual trees.
- (e) Cable Yarding shall provide suspension above Watercourses in a manner which achieves compliance with 14 CCR § 914 [934, 954].

954.4 Site Preparation Addendum [Southern only]

Where Site Preparation will occur on the logging area, the THP shall incorporate a Site Preparation addendum (also see 955.4) which includes the following information:

- (a) Whether Site Preparation will be required to meet stocking.
- (b) The general methods of Site Preparation to be used.
- (c) The types of equipment (if any) to be used for Mechanical Site Preparation and firebreak construction.
- (d) The methods for protecting any desirable residual trees in accordance with 14 CCR § 957.7.
- (e) Explanations and justifications for any exceptions or alternatives to the standard Rules.
- (f) A map identifying the boundaries of Site Preparation areas, if different from logging area boundaries, and distinguishing areas by type of Site Preparation activity.
- (g) The name, address, and telephone number of the person responsible for conduct of Site Preparation activities.
- (h) The estimated timing of Site Preparation operations.

914.5, 934.5, 954.5 Servicing of Logging Equipment, Disposal of Refuse, Litter, Trash and Debris [All Districts]

The following standards shall be adhered to in servicing logging equipment and disposing of refuse, litter, trash and debris:

- (a) Equipment used in Timber Operations shall not be serviced in locations where servicing will allow grease, oil, or fuel to pass into lakes or Watercourses.
- (b) Non-biodegradable refuse, litter, trash, and debris resulting from Timber Operations, and other activity in connection with the operations shall be disposed of concurrently with the conduct of Timber Operations.

914.6, 934.6, 954.6 Waterbreaks [All Districts, with variation]

(a) Waterbreaks shall be constructed on Tractor Roads, roads, Layouts, and Landings which do not have adequate natural drainage, drainage structures, or Surface Cover or Woody Debris to dissipate water flow and trap sediment to prevent soil loss.

(b) Except as otherwise provided for in the Rules:

- (1) All Waterbreaks shall be installed no later than the beginning of the Winter Period of the current year of Timber Operations.
- (2) Installation of Drainage Facilities and structures is required from October 15 to November 15 and from April 1 to May 1 on all constructed skid trails and Tractor Roads prior to sunset if the National Weather Service forecast is a “chance” (thirty (30) percent or more) of rain within the next twenty-four (24) hours.
- (c) Waterbreaks shall be constructed concurrently with the construction of firebreaks and immediately upon conclusion of use of Tractor Roads, roads, Layouts, and Landings which do not have permanent and adequate Drainage Facilities, or Drainage Structures.

(d) When Tethered Operations are proposed in a Plan, the RPF shall explain, in the Plan, how Tractor Roads used in those Tethered Operations will be treated, including any necessary mitigations and metrics for compliance, in order to minimize disturbance which could lead to soil loss and comply with 14 CCR § 914[934, 954].

(e) Distances between Waterbreaks shall not exceed the following standards:

CALIFORNIA FOREST PRACTICE RULES

MAXIMUM DISTANCE BETWEEN WATERBREAKS

Estimated Hazard Rating	U.S. Equivalent Measure Road or Trail Gradient (in percent)				Metric Measure Road or Trail Gradient (in percent)			
	10 or less	11-25	26-50	>50	10 or less	11-25	26-50	>50
	Feet	Feet	Feet	Feet	Meters	Meters	Meters	Meters
Extreme	100	75	50	50	30.48	22.86	15.24	15.24
High	150	100	75	50	45.72	30.48	22.35	15.24
Moderate	200	150	100	75	60.96	45.72	30.48	22.35
Low	300	200	150	100	91.44	60.96	45.72	30.48

The appropriate Waterbreak spacing shall be based upon the Erosion Hazard Rating and road or trail gradient.

(f) Cable Roads that are so deeply cut as to divert and carry water away from natural drainage patterns for more than one hundred (100) feet shall have Waterbreaks installed on them at one hundred (100) feet intervals, or other appropriate erosion control measure may be applied if specified in the Plan.

(g) Waterbreaks shall be installed at all natural Watercourses on Tractor Roads and firebreaks regardless of the maximum distances specified in this section, except where permanent drainage facilities are provided.

(h) Waterbreaks shall be located to allow water to be discharged into some form of vegetative cover, duff, Slash, rocks, or less erodible material wherever possible, and shall be constructed to provide for unrestricted discharge at the lower end of the Waterbreak so that water will be discharged and spread in such a manner that erosion shall be minimized. Where Waterbreaks cannot effectively disperse surface runoff, including where Waterbreaks on roads and skid trail cause surface run-off to be concentrated on downslopes, roads or skid trails, other erosion controls shall be installed as needed to comply with Title 14 CCR § 914 [934, 954].

(i) Waterbreaks shall be cut diagonally a minimum of six (6) inches into the firm roadbed, Cable Road, skid trail or firebreak surface and shall have a continuous firm embankment of at least six (6) inches in height immediately adjacent to the lower edge of the Waterbreak cut.

In the Southern Subdistrict of the Coast Forest District, on truck roads having firmly compacted surfaces, Waterbreaks installed by hand methods need not provide the additional six (6) inch embankment provided the Waterbreak ditch is constructed so that it is at least six (6) inches deep and six (6) inches wide on the bottom and provided there is ample evidence based on slope, material, amount of rainfall, and period of use that the Waterbreaks so constructed will be effective in diverting water flow from the road surface without the embankment.

(j) Waterbreaks or any other Erosion Controls on skid trails, Cable Roads, Layouts, firebreaks, Abandoned Roads, and Site Preparation areas shall be maintained during the prescribed maintenance period and during Timber Operations as defined in PRC §§ 4527 and 4551.5 so that they continue to function in a manner which minimizes soil erosion and slope instability and which prevents degradation of the quality and Beneficial Uses of water. The method and timing of Waterbreak repair and other erosion control maintenance shall be selected with due consideration given to the protection of residual trees and reproduction and the intent of 14 § CCR 914 [934, 954].

(k) The Prescribed Maintenance Period for Waterbreaks and any other erosion control facilities on skid trails, Cable Roads, Layouts, firebreaks, Abandoned Roads, and Site Preparation areas, shall be at least one year. The Director may prescribe a maintenance period extending as much as three years after filing of the work completion report in accordance with 14 CCR § 1050.

914.7, 934.7, 954.7 Timber Operations, Winter Period [All Districts]

During the winter period:

(a) Mechanical Site Preparation and timber harvesting, shall not be conducted unless a winter period operating plan is incorporated in the timber harvesting plan and is followed, or unless the requirements of

CALIFORNIA FOREST PRACTICE RULES

subsection (c) are met. Cable, helicopter and balloon Yarding methods are exempted.

(b) The winter period operating plan shall include the specific measures to be taken in the winter operating period to avoid or substantially lessen erosion, soil movement into Watercourses and soil compaction from Timber Operations. A winter period operating plan shall address the following subjects:

- (1) Erosion hazard rating.
- (2) Mechanical Site Preparation methods.
- (3) Yarding system (constructed skid trails and tractor road Watercourse crossings).
- (4) Operating period.
- (5) Erosion control facilities timing.
- (6) Consideration of form of precipitation-rain or snow.
- (7) Ground conditions (soil moisture condition, frozen).
- (8) Silvicultural system-ground cover.
- (9) Operations within the WLPZ.
- (10) Equipment use limitations.
- (11) Known unstable areas.
- (12) Logging Roads and Landings.

(c) In lieu of a winter period operating plan, the RPF can specify the following measures in the THP:

(1) Tractor Yarding or the use of tractors for constructing Logging Roads, Landings, Watercourse crossings, layouts, firebreaks or other tractor roads shall be done only during dry, rainless periods and shall not be conducted on saturated soil conditions that may produce significant sediment discharge.

(2) Erosion control structures shall be installed on all constructed skid trails and tractor roads prior to the end of the day if the U.S. Weather Service forecast is a "chance" (30% or more) of rain before the next day, and prior to weekend or other shutdown periods.

(3) Site specific mitigation measures needed to comply with 14 CCR § 914 [934, 954] for operations within the WLPZ and unstable areas during the winter period.

The provisions of subsection (c) do not apply to Mechanical Site Preparation.

914.8, 934.8, 954.8 Tractor Road Watercourse Crossing [All Districts]

Watercourse crossing facilities on tractor roads shall be planned, constructed, maintained, and removed according to the following standards:

(a) The number of crossings shall be kept to a minimum. Existing crossing locations shall be used wherever feasible.

(b) A prepared Watercourse crossing using a structure such as a bridge, culvert, or temporary log culvert shall be used to protect the Watercourse from siltation where tractor roads cross a Watercourse in which water may be present during the life of the crossing.

(c) Crossing facilities on Watercourses that support fish shall allow for unrestricted passage of all life stages of fish that may be present, and for unrestricted passage of water. Such crossing facilities shall be fully described in sufficient clarity and detail to allow evaluation by the review team and the public, provide direction to the LTO for implementation, and provide enforceable standards for the inspector.

(d) Tractor road Watercourse crossing facilities shall be removed and stabilized before the beginning of the winter period to the standards of 14 CCR § 923.9 [943.9, 963.9], subsections (p)(1)-(4), or as specified in the winter period operating plan. The RPF may propose an exception if explained and justified in the plan. The exception may be approved if found by the Director to be in conformance with this article.

(e) If the Watercourse crossing involves a culvert, the minimum diameter shall be stated in the THP and the culvert shall be of a sufficient length to extend beyond the fill material.

(f) Consistent with the protection of water quality, exceptions may be provided through the Fish and Game Code and shall be indicated in the plan.

914.9, 934.9, 954.9 Alternatives to Standard Rules [All Districts]

(a) Alternative practices may be developed by the RPF on a site-specific basis provided the following conditions are complied with and the alternative practices will achieve environmental protection at least equal to that which would result from using measures stated in 14 CCR §§ 914.1-914.8, 934.1-934.8, 954.1-954.8.

CALIFORNIA FOREST PRACTICE RULES

(1) Environmental Impacts with potential for significant adverse effects on the beneficial uses of water, on the residual timber, and on the soil productivity are identified and measures proposed to mitigate such Impacts are included in an approved THP. The THP shall also contain a clear statement as to why alternative harvesting and erosion control measures are needed.

(2) The alternative practice(s) must be explained in sufficient detail and standards provided in the THP so that they can be adequately evaluated and enforced by the Director and implemented by the licensed Timber Operator.

(3) On a THP in which alternatives covering harvesting and erosion control measures have been incorporated, the Timber Operator shall agree to the alternative specifications by signing and filing with the Director a copy of the plan, the amended plan or a facsimile thereof, prior to beginning or continuing operations on the portion of the plan to which the alternatives apply.

(b) The Director shall not accept for inclusion in a THP alternative harvesting and erosion control measures proposed under this section which do not meet the standard of subsection (a) of this section. In the event that there is more than one written negative position showing that the alternative practice(s) does (do) not meet the standard of subsection (a) received from among the agencies listed in 14 CCR 1037.3 and the Department which participated in the review of the plan including on-the-ground inspection, the Director shall reject the proposed alternative.

(c) Alternative practices stated in an approved THP shall have the same force and authority as those practices required by the standard rule.

Article 5 Site Preparation

915, 935, 955 Purposes [All Districts]

Site Preparation shall be planned and conducted in a manner which encourages maximum timber productivity, minimizes fire hazards, prevents substantial adverse effects to soil resources and to fish and wildlife habitat, and prevents degradation of the quality and beneficial uses of water. The following provisions shall be applied in a manner which complies with this standard.

915.1, 935.1, 955.1 Use of Heavy Equipment for Site Preparation [All Districts]

(a) Use of heavy equipment for Site Preparation shall comply with the provisions set forth in 14 CCR §§ 914.2, 934.2, 954.2.

(b) Heavy equipment shall not be used for Site Preparation under saturated soil conditions that may produce significant sediment discharge; or when it cannot operate under its own power due to wet conditions.

(c) Watercourse crossings for heavy equipment shall be planned, constructed, maintained, and removed in accordance with the requirements for tractor roads in 14 CCR §§ 914.8, 934.8, 954.8.

(d) Undisturbed areas or energy dissipators shall be used to control and disperse concentrated runoff from roads, Landings, tractor roads, firebreaks and erosion control facilities where it flows into Site Preparation areas.

915.2, 935.2, 955.2 Treatment of Vegetative Matter [All Districts]

(a) Piling, burning, and other treatment of snags, Slash and vegetative matter and protection of desirable residual trees during Site Preparation shall comply with 14 CCR §§ 917, 937, 957 through 917.7 937.7, 957.7.

(b) Broadcast Burning shall not fully consume the larger organic debris which retains soil on slopes and stabilizes Watercourse banks. The Director may approve exceptions to this requirement when such exceptions are explained and justified in the THP and the exceptions would provide for the protection of the beneficial uses of water or control erosion to a standard at least equal to that which would result from application of the standard rule.

915.3, 935.3, 955.3 Protection of Natural Resources [All Districts]

(a) Site Preparation activities shall comply with the Watercourse and lake protection requirements in 14 CCR Article 6 and §§ 917.3, 937.3, 957.3.

CALIFORNIA FOREST PRACTICE RULES

(b) Site Preparation activities shall comply with the wildlife and habitat protection provisions of 14 CCR Article 9.

(c) Site Preparation shall be performed in a manner which does not deleteriously affect species which are threatened, endangered, or designated by the Board as species of special concern. The Director may allow exceptions to this standard in the plan, after consultation with the CDFW pursuant to the California Endangered Species Act (F&G Code 2050-2098).

915.4, 935.4, 955.4 Site Preparation Addendum [All Districts]

Where Site Preparation will occur on the logging area, the THP shall incorporate a Site Preparation addendum which includes the following information:

- (a) Whether Site Preparation will be required to meet stocking.
- (b) The general methods of Site Preparation to be used.
- (c) The types of equipment, if any, to be used for Mechanical Site Preparation and firebreak construction.
- (d) The methods for protecting any desirable residual trees in accordance with 14 CCR 917.7 [937.7, 957.7].
- (e) Explanations and justifications for any exceptions or alternatives to the standard Rules.
- (f) A map identifying the boundaries of Site Preparation areas, if different from logging area boundaries, and distinguishing areas by type of Site Preparation activity.
- (g) The name, address, and telephone number of the person responsible for conduct for Site Preparation activities shall be provided prior to conducting Site Preparation activities.
- (h) The estimated timing of Site Preparation operations.

Article 6 Watercourse and Lake Protection

916, 936, 956 Intent of Watercourse and Lake Protection [All Districts]

The purpose of this article is to ensure that Timber Operations do not potentially cause significant adverse site-specific and cumulative Impacts to the beneficial uses of water, native aquatic and Riparian-associated species, and the beneficial functions of Riparian zones; or result in an unauthorized take of listed aquatic species; or threaten to cause violation of any applicable legal requirements. This article also provides protection measures for application in watersheds with listed anadromous salmonids and watersheds listed as water quality limited under Section 303(d) of the Federal Clean Water Act.

It is the intent of the Board to restore, enhance, and maintain the productivity of Timberlands while providing appropriate levels of consideration for the quality and beneficial uses of water relative to that productivity. Further, it is the intent of the Board to clarify and assign responsibility for recognition of potential and existing Impacts of Timber Operations on Watercourses and lakes, native aquatic and Riparian-associated species, and the beneficial functions of Riparian zones and to ensure all plans, exemptions and emergency notices employ feasible measures to effectively achieve compliance with this article. Further, it is the intent of the Board that the evaluations that are made, and the measures that are taken or prescribed, be documented in a manner that clearly and accurately represents those existing conditions and those measures. "Evaluations made" pertain to the assessment of the conditions of the physical form, water quality, and biological characteristics of Watercourses and lakes, including cumulative Impacts affecting the beneficial uses of water on both the area of planned logging operations and in the Watershed Assessment Area (WAA). "Measures taken" pertain to the procedures used or prescribed for the restoration, enhancement, and maintenance of the beneficial uses of water.

All provisions of this article shall be applied in a manner, which complies with the following:

- (a) During and following Timber Operations, the beneficial uses of water, native aquatic and Riparian-associated species, and the beneficial functions of Riparian zones shall be maintained where they are in good condition, protected where they are threatened, and insofar as feasible, restored where they are impaired.
- (b) Maintenance, protection, and contribution towards restoration of the quality and beneficial uses of water during the planning, review, and conduct of Timber Operations shall comply with all applicable legal requirements including those set forth in any applicable water quality control plan adopted or approved by the State Water Resources Control Board. At a minimum, the LTO shall not remove water, trees or large woody debris from a Watercourse or lake, the adjacent Riparian area, or the adjacent flood prone areas in

CALIFORNIA FOREST PRACTICE RULES

quantities deleterious to fish, wildlife, beneficial functions of Riparian zones, or the quality and beneficial uses of water.

(c) Protecting and restoring native aquatic and Riparian-associated species, the beneficial functions of Riparian zones, and the quality and beneficial uses of water shall be given equal consideration as a management objective within any prescribed WLPZ and within any ELZ or EEZ designated for Watercourse or lake protection and any other location where Timber Operations may affect Riparian zones or the quality and beneficial uses of water.

(d) The measures set forth in this Section are meant to enforce the public's historical and legal interest in protection for wildlife, fish, and water quality and are to be used to guide Timberland Owners in meeting their legal responsibilities to protect public trust resources.

916.1, 936.1, 956.1 In Lieu Practices [All Districts]

In rule sections where provision is made for site specific practices to be proposed by the RPF, approved by the Director and included in the THP in lieu of a stated rule, the RPF shall reference the standard rule, shall explain and describe each proposed practice, how it differs from the standard practice, and the specific locations where it shall be applied; and shall explain and justify how the protection provided by the proposed practice is at least equal to the protection provided by standard rule.

(a) The in lieu practice(s) must provide for the protection of the beneficial uses of water to the standards of 14 CCR §§ 916.3, 936.3, 956.3 and 916.4(b), 936.4(b), 956.4(b).

(b) In lieu practices stated in an approved THP shall have the same enforceability and legal authority as those practices required by the standard Rules.

(c) Any in lieu practices which propose less than standard rule WLPZ widths for Class I Watercourses shall include 14 CCR §§ 916.5(e), 936.5(e), 956.5(e), "A" & "D" protection measures.

916.2, 936.2, 956.2 Protection of the Beneficial Uses of Water and Riparian Functions [All Districts]

(a) The measures used to protect each Watercourse and lake in a logging area shall be determined by the presence and condition of the following values:

(1) The existing and restorable quality and beneficial uses of water as specified by the applicable water quality control plan and as further identified and refined during preparation and review of the plan.

(2) The existing and restorable uses of water for fisheries as identified by the CDFW or as further identified and refined during preparation and review of the plan.

(3) The beneficial functions of the Riparian zone that provides for the biological needs of native aquatic and Riparian-associated species as specified in 14 CCR § 916.4 [936.4, 956.4] subsection (b) and 14 CCR §§ 916.9, 936.9, 956.9, when the plan is in a planning watershed with listed anadromous salmonids.

(4) Sensitive conditions near Watercourses and lakes as specified in 14 CCR §§ 916.4, 936.4, 956.4, subsection (a).

The maintenance, protection, and contribution towards restoration of these values shall be achieved through a combination of the Rules and plan-specific mitigation. The RPF shall propose, and the Director may require, adequate protection of overflow and changeable channels which are not contained within the Channel Zone.

(b) The State's waters are grouped into four classes based on key beneficial uses. These classifications shall be used to determine the appropriate protection measures to be applied during the conduct of Timber Operations. The basis for classification (characteristics and key beneficial uses) are set forth in 14 CCR §§ 916.5, 936.5, 956.5, Table 1 and the range of appropriate protective measures applicable to each class are contained in 14 CCR §§ 916.3, 936.3, 956.3, 916.4, 936.4, 956.4, and 916.5, 936.5, 956.5, and 916.9, [936.9, 956.9] when the plan is in a planning watershed with listed anadromous salmonids.

(c) When the protective measures contained in 14 CCR §§ 916.5, 936.5, 956.5, and 916.9, 936.9, 956.9 when the plan is in a planning watershed with listed anadromous salmonids, are not adequate to provide for maintenance, protection or to contribute towards restoration of beneficial uses of water set forth in 14 CCR §§ 916.5, 936.5, 956.5 Table 1, additional measures to achieve these goals shall be developed by the RPF or proposed by the Director under the provisions of 14 CCR §§ 916.6, 936.6, 956.6, Alternative Watercourse and Lake Protection, and incorporated in the plan when approved by the Director.

CALIFORNIA FOREST PRACTICE RULES

916.3, 936.3, 956.3 General Limitations Near Watercourses, Lakes, Marshes, Wet Meadows and Other Wet Areas [All Districts]

The quality and beneficial uses of water shall not be unreasonably degraded by Timber Operations. During Timber Operations, the Timber Operator shall not place, discharge, or dispose of or deposit in such a manner as to permit to pass into the water of this state, any substances or materials, including, but not limited to, soil, silt, bark, Slash, sawdust, or petroleum, in quantities deleterious to fish, wildlife, or the quality and beneficial uses of water. All provisions of this article shall be applied in a manner which complies with this standard.

(a) When there is reasonable expectation that Slash, debris, soil, or other material resulting from Timber Operations, falling or associated activities, will be deposited in Class I and Class II waters below the Watercourse or Lake Transition Line or in Watercourses which contain or conduct Class IV water, those harvest activities shall be deferred until equipment is available for its removal, or another procedure and schedule for completion of corrective work is approved by the Director.

(b) Accidental depositions of soil or other debris in lakes or below the Watercourse or lake Lake Transition Line in waters classed I, II, and IV shall be removed immediately after the deposition or as approved by the Director.

(c) The Timber Operator shall not construct or use tractor roads in Class I, II, III or IV Watercourses, in the WLPZ, marshes, Wet Meadows, and Other Wet Areas unless explained and justified in the plan by the RPF, and approved by the Director, except as follows:

(1) At prepared tractor road crossings as described in 14 CCR §§ 914.8(b), 934.8(b), 954.8(b).

(2) Crossings of Class III Watercourses that are dry at the time of use.

(3) At new and existing tractor road crossings approved as part of the Fish and Game Code process (F&GC § 1600 et seq.).

(d) Vegetation, other than commercial species, bordering and covering Meadows and Wet Areas shall be retained and protected during Timber Operations unless explained and justified in the THP and approved by the Director. Soil within the Meadows and Wet Areas shall be protected to the maximum extent possible.

(e) Trees cut within the WLPZ shall be felled away from the Watercourse by pulling or other mechanical methods if necessary, in order to protect the residual vegetation in the WLPZ. Exceptions may be proposed in the THP and used when approved by the Director.

(f) Where less than 50% canopy exists in the WLPZs of Class I and II waters before Timber Operations, only sanitation salvage which protects the values described in 14 CCR §§ 916.4(b), 936.4(b), 956.4(b) shall be allowed.

(g) Recruitment of large woody debris for instream habitat shall be provided by retaining at least two living conifers per acre at least 16 inches diameter breast high and 50 ft. tall within 50 ft. of all Class I and II Watercourses.

916.4, 936.4, 956.4 Watercourse and Lake Protection [All Districts]

(a) The RPF or supervised designee shall conduct a field examination and map all lakes and Class I, II, III, and IV Watercourses.

(1) As part of this field examination, the RPF or supervised designee shall evaluate areas near, and areas with the potential to directly Impact, Watercourses and lakes for sensitive conditions including, but not limited to, existing and proposed roads, skid trails and Landings, unstable and erodible Watercourse banks, unstable upslope areas, debris jam potential, inadequate flow capacity, migrating channels, overflow channels, flood prone areas, and Riparian zones wherein the values set forth in 14 CCR §§ 916.4, 936.4, 956.4, subsection (b) are impaired. The RPF shall consider these conditions, and those measures needed to maintain, and restore to the extent feasible, the functions set forth in 14 CCR §§ 916.4(b), 936.4(b), 956.4(b) when proposing WLPZ widths and protection measures. The plan shall identify such conditions, including where they may interact with proposed Timber Operations, that individually or cumulatively significantly and adversely affect the beneficial uses of water, and shall describe measures to protect and restore to the extent feasible, the beneficial uses of water. In proposing, reviewing, and approving such measures, preference shall be given to measures that are on-site, or to offsite measures where sites are located to maximize the benefits to the Impacted portion of a Watercourse or lake.

(2) As part of this field examination, the RPF or supervised designee shall map the location of spawning and rearing habitat for anadromous salmonids, and the condition of the habitat shall be evaluated

CALIFORNIA FOREST PRACTICE RULES

using habitat typing that at a minimum identifies the pool, flatwater, and riffle percentages. The opportunity for habitat restoration shall be described within the plan for each Class I Watercourse, and for each Class II Watercourse that can be feasibly restored to a Class I.

(3) The mapping of conditions identified in subsection (a)(1) and (a)(2) above, and their protective measures, shall be sufficiently clear and detailed to permit the Director and the other review team representatives to evaluate the potential environmental Impacts of Timber Operations, the proposed mitigation measures and the proposed restoration measures.

(4) The mapping of conditions identified in subsection (a)(1) and (a)(2) above, and their protective measures, shall be sufficiently clear and detailed to provide direction and clear guidance to the Timber Operator.

(5) The mapping of conditions identified in 14 CCR §§ 916.4, 936.4, 956.4 subsections (a)(1) and (a)(2), and their protective and restoration measures, should be done at a scale of 1:2,400. In site-specific cases, the mapping of critical locations of corrective work and logging operation Impacts shall be done at a scale of at least 1:240 when the Director determines it is necessary to evaluate the plan.

(6) One set of photocopies of recent stereo aerial photographs of the plan area may be required by the Director.

(b) The standard width of the WLPZ and/or the associated basic protection measures shall be determined from Table I (14 CCR §§ 916.5, 936.5, 956.5) or §§ 916.4(c), 936.4(c), 956.4(c), and shall be stated in the plan. A combination of the Rules, the plan, and mitigation measures shall provide protection for the following:

- a. Water temperature control.
- b. Streambed and flow modification by large woody debris.
- c. Filtration of organic and inorganic material.
- d. Upslope stability.
- e. Bank and channel stabilization.
- f. Spawning and rearing habitat for salmonids
- g. Vegetation structure diversity for fish and wildlife habitat, possibly including but not limited to:
 1. Vertical diversity
 2. Migration corridor
 3. Nesting, roosting, and escape
 4. Food abundance
 5. Microclimate modification
 6. Snags
 7. Surface cover

(1) Measures and the appropriate zone widths for the protection of the State's waters which have been taken from Table I (14 CCR 916.5, 936.5, 956.5) or developed under §§ 916.4(c), 936.4(c), 956.4(c) shall be stated in the THP.

(2) All Timber Operations shall conform to the marking, flagging and other identification of protective measures specified in CCR §§ 916.4, 936.4, 956.4, and 916.5, 936.5, 956.5 and the THP. Conformance shall be determined based on the evaluation of no less than a 200 foot lineal segment of each Watercourse or lake.

(3) The width of the WLPZ shall be measured along the surface of the ground from the Watercourse or Lake Transition Line or in the absence of Riparian vegetation from the top edge of the Watercourse bank.

(4) Slopes shall be measured in percent for the proposed WLPZ. If topography within the proposed WLPZ is variable, segments of the proposed WLPZ should be segregated by slope class as indicated in Table I, 14 CCR §§ 916.5, 936.5, 956.5.

(5) If requested by either party, and after on-the-ground inspection, the RPF and the Director may increase or decrease the width of a proposed WLPZ. A decrease shall not exceed 25 percent of the width as determined by the procedure prescribed in Sections 14 CCR §§ 916.4(c), 936.4(c), 956.4(c), and 916.5, 936.5, 956.5. Such changes in zone width shall be based on considerations of soil, slope, climatic factors, biologic, hydrologic, and geologic values listed in §§ 14 CCR 916.4(b), 936.4(b), 956.4(b), silvicultural methods, Yarding systems, road location, and Site Preparation activities. In no case shall the width be adjusted to less than 50 feet for Class I and II waters. Where soil surfaced roads exist within the standard WLPZ, no in-lieu reduction of WLPZ width shall be approved.

(6) Within the WLPZ, at least 75% surface cover and undisturbed area shall be retained to act as a filter strip for raindrop energy dissipation, and for wildlife habitat. This percentage may be adjusted to meet

CALIFORNIA FOREST PRACTICE RULES

site specific conditions when proposed by the RPF and approved by the Director or where Broadcast Burning is conducted under the terms of a project type burning permit and in compliance with 14 CCR §§ 915.2(b), 935.2(b), 955.2(b).

(c) The protection and WLPZ widths for Class III and Class IV waters shall prevent the degradation of the downstream beneficial use of water and shall be determined on a site-specific basis.

(1) Where operations occur adjacent to Class III Watercourses, the RPF shall designate in the THP an equipment limitation zone (ELZ) of at least 25 feet where sideslope steepness is less than 30% and at least 50 feet where sideslope steepness is 30% or greater unless explained and justified otherwise in the THP and approved by the Director. Class III Watercourses within logging areas where the EHR is Low and the slopes are less than 30% shall not require an ELZ unless proposed by the RPF or required by the Director. The RPF shall describe the limitations on the use of heavy equipment in the THP. Where appropriate to protect the beneficial uses of water, the RPF shall describe additional protection measures, which may include surface cover retention, vegetation protection and timber falling limitations. The location of the areas of heavy equipment use in any ELZ shall be clearly described in the plan, or flagged or marked on the ground before the preharvest inspection. When necessary to protect the beneficial use of water, the RPF shall designate and the Director may require a WLPZ for Class III and Class IV waters or an ELZ for Class IV waters.

(2) The width of the WLPZ for Class III and IV waters shall be determined from on-site inspection. Minimum protective measures required when Class III and Class IV protection zones are necessary are contained in Table I 14 CCR §§ 916.5, 936.5, 956.5.

(3) Soil deposited during Timber Operations in a Class III Watercourse other than at a temporary crossing shall be removed and debris deposited during Timber Operations shall be removed or stabilized before the conclusion of Timber Operations, or before October 15. Temporary crossings shall be removed before the winter period, or as approved by the Director.

(4) When approved by the Director on an individual plan basis as provided in Section 14 CCR §§ 916.4(c)(1), 936.4(c)(1), 956.4(c)(1) Class IV waters shall be exempted from required protection when such protection is inconsistent with the management objectives of the owner of the manmade Watercourse.

(d) Heavy equipment shall not be used in timber falling, Yarding, or Site Preparation within the WLPZ unless such use is explained and justified in the THP and approved by the Director.

(e) Flagging for heavy equipment use within the WLPZ adjacent to Class I waters and for all tractor road Watercourse crossings of all Watercourses must be completed before the preharvest inspection if one is conducted or start of operations, whichever comes first. Flagging for heavy equipment use within the WLPZ adjacent to Class II, III and IV waters may be done at the option of the RPF or as required by the Director on a site-specific basis.

(f) Subsection (d) does not apply to (1)-(4) below. Subsection (e) does not apply to (2)-(4) below.

(1) At prepared tractor road crossings as described in §§ 914.8(b), 934.8(b), 954.8(b).

(2) Crossings of Class III Watercourses which are dry at the time of Timber Operations.

(3) At existing road crossings.

(4) At new tractor and road crossings approved as part of the Fish and Game Code Process (F&GC 1600 et seq.).

916.5, 936.5, 956.5 Procedure for Determining Watercourse and Lake Protection Zone (WLPZ) Widths and Protective Measures [All Districts]

The following procedure for determining WLPZ widths and protective measures shall be followed:

(a) The following information shall be determined from field investigation:

(1) The location of all lakes and Watercourses including man made Watercourses.

(2) The existing and restorable beneficial uses of the waters to be protected as identified in subsection (1) above.

(3) The side slope classes for the individual class of waters to be protected (e.g. < 30%, 30-50%, >50%), where side slope is measured from the Watercourse or Lake Transition Line to a point 100 feet upslope from the Watercourse or Lake Transition Line, or, in the absence of Riparian vegetation, from the top of the Watercourse bank where slope configurations are variable, a weighted average method shall be used to determine sideslope percent.

(b) The beneficial uses noted from the field investigations in subsection (a) shall be compared to the

CALIFORNIA FOREST PRACTICE RULES

characteristics or key beneficial uses listed in Row 1 of Table I (14 CCR §§ 916.5, 936.5, 956.5) to determine the water classes (e.g. I, II, III, IV, Row 2).

(c) The standard protection zone width differentiated by slope classes determined in Subsection (a) are shown in Rows 4-7, Table I (14 CCR 916.5 [936.5, 956.5]). These widths may be modified as stated in 14 CCR §§ 916.4(b)(5), 936.4(b)(5), 956.4(b)(5).

(d) The alphabetical letter designations A through I in Rows 4-7, Table 1 14 CCR §§ 916.5, 936.5, 956.5, and described in subsection (e) to Table I indicate the standard protective measures to be applied to the classes of water as determined in subsection (b) above.

(e) The letter designations shown in the "Protective Measures and Widths" column in Table I correspond to the following:

"A" WLPZ shall be clearly identified on the ground by the RPF who prepared the plan, or supervised designee, with paint, flagging, or other suitable means prior to the preharvest inspection. For nonindustrial timber management plans, sample identification of the WLPZ prior to the preharvest inspection may be allowed. The sample shall be based upon a field examination and be consistent with the applicable provisions of 14 CCR §§ 916.4, 936.4, 956.4 and 916.5, 936.5, 956.5, representing the range of conditions found within the WLPZ. The Director shall determine if the sample identification is adequate for plan evaluation during the preharvest inspection. If sample identification is allowed, the remaining WLPZ shall be identified by an RPF or supervised designee prior to the start of Timber Operations within or adjacent to the WLPZ. The RPF shall notify the Department when the WLPZ has been identified.

"B" WLPZ shall be clearly identified on the ground by an RPF or supervised designee, with paint, flagging, or other suitable means, prior to the start of Timber Operations. In watersheds with listed anadromous salmonids, on the ground identification of the WLPZ shall be completed prior to the preharvest inspection. For all NTMPs and WFMPs, sample identification of the WLPZ prior to the preharvest inspection may be allowed. The sample shall be based upon a field examination and be consistent with the applicable provisions of 14 CCR §§ 916.4, 936.4, 956.4 and 916.5, 936.5, 956.5, representing the range of conditions found within the WLPZ. The Director shall determine if the sample identification is adequate for Plan evaluation during the preharvest inspection. If sample identification is allowed, the remaining WLPZ shall be identified by an RPF or supervised designee prior to the start of Timber Operations within or adjacent to the WLPZ. The RPF shall notify the Department when the WLPZ has been identified.

"C" In site-specific cases, the RPF may provide in the plan, or the Director may require, that the WLPZ be clearly identified on the ground with flagging or by other suitable means prior to the start of Timber Operations.

"D" To ensure retention of shade canopy filter strip properties of the WLPZ and the maintenance of a multi-storied stand for protection of values described in 14 CCR §§ 916.4(b), 936.4(b), 956.4(b), residual or harvest trees shall be marked, including a base mark below the cut-line within the WLPZ by the RPF, or supervised designee. Outside of watersheds with listed anadromous salmonids, sample marking prior to the preharvest inspection is satisfactory in those cases where the Director determines it is adequate for Plan evaluation. When sample marking has been used, the remaining WLPZ shall be marked in advance of falling operations by the RPF, or supervised designee. In watersheds with listed anadromous salmonids, trees shall be marked in advance of the preharvest inspection. For all NTMPs and WFMPs, sample marking of the WLPZ prior to the preharvest inspection may be allowed. The sample shall be based upon a field examination and shall be consistent with the applicable provisions of 14 CCR §§ 916.4, 936.4, 956.4 and 916.5, 936.5, 956.5, representing the range of conditions found within the WLPZ. The Director shall determine if the sample mark is adequate for Plan evaluation during the preharvest inspection. If sample marking is allowed, the remaining WLPZ shall be marked by an RPF, or supervised designee, prior to the start of Timber Operations within or adjacent to the WLPZ. The RPF shall notify the Department when the WLPZ has been identified.

"E" To ensure retention of shade canopy filter strip properties of the WLPZ and the maintenance of a multi-storied stand for protection of values described in 14 CCR §§ 916.4(b), 936.4(b), 956.4(b), residual or harvest trees shall be marked, including a base mark below the cut line, within the WLPZ by the RPF or supervised designee. Outside of watersheds with listed anadromous salmonids, tree marking shall be done prior to timber falling operations. In watersheds with listed anadromous salmonids, trees shall be marked in advance of the preharvest inspection. For all NTMPs and WFMPs, sample marking of the WLPZ

CALIFORNIA FOREST PRACTICE RULES

prior to the preharvest inspection may be allowed. The sample shall be based upon a field examination and shall be consistent with the applicable provisions of 14 CCR §§ 916.4, 936.4, 956.4 and 916.5 936.5, 956.5, representing the range of conditions found within the WLPZ. The Director shall determine if the sample mark is adequate for Plan evaluation during the preharvest inspection. If sample marking is allowed, the remaining WLPZ shall be marked by an RPF or supervised designee prior to the start of Timber Operations within or adjacent to the WLPZ. The RPF shall notify the Department when the WLPZ has been identified.

"F" Residual or harvest tree marking within the WLPZ may be stipulated in the THP by the RPF or required by the Director in site-specific cases to ensure retention of filter strip properties or to maintain soil stability of the zone. The RPF shall state in the THP if marking was used in these zones.

"G" To protect water temperature, filter strip properties, upslope stability, and fish and wildlife values, at least 50% of the overstory and 50% of the understory canopy covering the ground and adjacent waters shall be left in a well distributed multi-storied stand composed of a diversity of species similar to that found before the start of operations. The residual overstory canopy shall be composed of at least 25% of the existing overstory conifers. Species composition may be adjusted consistent with the above standard to meet on-site conditions when agreed to in the THP by the RPF and the Director.

"H" At least 50% of the understory vegetation present before Timber Operations shall be left living and well distributed within the WLPZ to maintain soil stability. This percentage may be adjusted to meet on-site conditions when agreed to in the THP by the RPF and the Director. Unless required by the Director, this shall not be construed to prohibit Broadcast Burning with a project type burning permit for Site Preparation.

"I" To protect water temperature, filter strip properties, upslope stability, and fish and wildlife values, at least 50% of the total canopy covering the ground shall be left in a well distributed multi-storied stand configuration composed of a diversity of species similar to that found before the start of operations. The residual overstory canopy shall be composed of at least 25% of the existing overstory conifers. Due to variability in Class II Watercourses these percentages and species composition may be adjusted to meet on-site conditions when agreed to by the RPF and the Director in the THP.

CALIFORNIA FOREST PRACTICE RULES

916.5, 936.5, 956.5 Procedures for Determining Watercourse and Lake Protection Zone Widths and Protective Measures [All Districts]

TABLE I

Procedures for Determining Watercourse and Lake Protection Zone Widths and Protective Measures¹								
Water Class Characteristics or Key Indicator Beneficial Use	1) Domestic supplies, including springs, on site and/or within 100 feet downstream of the operations area and/or		1) Fish always or seasonally present offsite within 1000 feet downstream and/or		No aquatic life present, Watercourse showing evidence of being capable of sediment transport to Class I and II waters under normal high water flow conditions after completion of Timber Operations.		Man-made Watercourses, usually downstream, established domestic, agricultural, hydroelectric supply or other beneficial use.	
	2) Fish always or seasonally present onsite, includes habitat to sustain fish migration and spawning.		2) Aquatic habitat for nonfish aquatic species.					
	3) Excludes Class III waters that are tributary to Class I waters.							
Water Class	Class I		Class II		Class III		Class IV	
Slope Class (%)	Width Feet	Protection Measure	Width Feet	Protection Measure	Width Feet	Protection Measure	Width Feet	Protection Measure
					[see 916.4(c)] [see 936.4(c)] [see 956.4(c)]		[see 916.4(c)] [see 936.4(c)] [see 956.4(c)]	
<30	75	BDG	50	BEI	See CFH		See CFI	
30-50	100	BDG	75	BEI	See CFH		See CFI	
>50	150 ²	ADG	100 ³	BEI	See CFH		See CFI	
<p>1 - See Section 916.5(e) for letter designations application to this table.</p> <p>2 – Subtract 50 feet width for cable Yarding operations.</p> <p>3 – Subtract 25 feet width for cable Yarding operations.</p>								

916.6, 936.6, 956.6 Alternative Watercourse and Lake Protection [All Districts]

(a) Alternative prescriptions for the protection of Watercourses and lakes may be developed by the RPF or proposed by the Director on a site-specific basis provided the following conditions are complied with and the alternative prescriptions will achieve compliance with the standards set forth in 14 CCR §§ 916.3, 936.3, 956.3 and 916.4(b), 936.4(b), 956.4(b).

(1) The following information regarding an alternative prescription shall be included in the THP:

(A) An identification of each standard prescription which would be replaced by the alternative prescription.

(B) An identification of any beneficial uses of water or other features listed in 14 CCR §§ 916.4(b), 936.4(b), 956.4(b), which may be adversely affected by the replaced standard prescription and the

CALIFORNIA FOREST PRACTICE RULES

alternative practice.

(C) An evaluation of any significant effects on such beneficial uses or features due to implementation of the alternative prescription.

(D) A clear and complete explanation and justification as to the reasons why, given site-specific technical, environmental, economic, or institutional considerations, an alternative prescription is needed. The reasons given must include at least one of the following:

(1) Implementation of the specified standard prescriptions would not be feasible.

(2) Implementation of the specified standard prescription(s) would not adequately prevent or reduce damage to the quality and beneficial uses of water.

(3) Implementation of the proposed alternative prescription would provide equal or greater protection, including all proposed mitigations for the quality and beneficial uses of water and those features listed in §§ 916.4(b) [936.4(b), 956.4(b)] than would implementation of the specified standard prescriptions.

(E) A plan for evaluating the results of the proposed alternative practice by either the plan submitter or the Director. The plan must include the criteria and procedures for evaluating and inspecting each approved alternative practice.

(2) The alternative measures stated in the plan shall be written so that they provide clear, enforceable standards for the guidance of the Timber Operator.

(3) Prior to beginning or continuing an operation in which alternative measures have been added to an approved THP in regard to Watercourse and lake protection measures, the Timber Operator shall acknowledge the new specifications by signing and filing with the Director, a copy of the amended plan.

(b) The Director shall not accept for inclusion in a THP alternative Watercourse and lake protection measures which do not meet the standard of subsection (a) of this section. In the event that written comments received from two or more agencies listed in PRC § 4582.6 and 14 CCR § 1037.3 and which participated in review of the plan, including on-the-ground inspection, lead to the conclusion that the proposed alternative does not meet the criteria of 14 CCR §§ 916.5, 936.5, 956.5, and is therefore not consistent with Rules of the Board, the Director shall reject the proposed alternative.

(c) Alternative practices stated in an approved THP shall have the same force and authority as those practices required by the standard rule.

916.7, 936.7, 956.7 Reduction of Soil Loss [All Districts]

Within the Watercourse and lake protection zone adjacent to Class I and Class II waters, areas where mineral soil exceeding 800 continuous square feet in size, exposed by Timber Operations, shall be treated for reduction of soil loss. Treatment shall be done prior to October 15th except that such bare areas created after October 15th shall be so treated within 10 days, or as agreed to by the Director. Stabilization measures shall be included and explained in the THP or other required notices. Stabilization measures shall be selected that will prevent significant movement of soil into Class I and II waters and may include, but need not be limited to, mulching, rip-rapping, grass seeding, or chemical soil stabilizers.

(a) This section does not apply to the traveled surface of roads. Erosion control measures on road surfaces are specified in 14 CCR §§ 923, 943, 963.

(b) Where mineral soil has been exposed by Timber Operations on approaches to Watercourse crossings of Class I or II waters, or Class III waters if an ELZ or WLPZ is required, the disturbed area shall be stabilized to the extent necessary to prevent the discharge of soil into Watercourses or lakes in amounts deleterious to the quality and beneficial uses of water.

(c) Where necessary to protect beneficial uses of water from Timber Operations, protection measures, such as seeding, mulching, or replanting, shall be specified to retain and improve the natural ability of the ground cover within the standard width of the WLPZ to filter sediment, minimize soil erosion, and stabilize banks of Watercourses and lakes.

916.8, 936.8, 956.8 Sensitive Watersheds [All Districts]

The Board, at a public hearing, shall determine whether nominated planning watersheds are "sensitive" to further Timber Operations. Classification of a watershed as "sensitive" shall be supported by substantial evidence that a condition, or conditions, exist(s) where further Timber Operations within the planning

CALIFORNIA FOREST PRACTICE RULES

watershed will create a reasonable potential to cause, or contribute to ongoing, significant adverse cumulative effect(s) on the resources identified in 14 CCR §§ 916.8(a)(3), 936.8(a)(3), 956.8(a)(3), and as set forth in Technical Rule Addendum No. 2 (14 CCR §§ 912.9, 932.9, 952.9) and that mitigation of such significant cumulative effects requires the application of protection measures not required by the Forest Practice Rules. For all planning watersheds classified as "sensitive", the Board shall identify the specific resources which are sensitive to further Timber Operations and specific mitigation measures that will provide the necessary protection of the sensitive resource(s). A Board finding that a planning watershed is no longer sensitive shall be supported by substantial evidence that such conditions no longer exist. Unless and until a planning watershed(s) is classified as sensitive and any necessary rulemaking completed, the existing Rules shall apply:

(a) Nomination process: The Director, local, state, or federal agencies and the public may nominate planning watersheds to the Board and shall provide evidence supporting classification of the watershed as sensitive. The nominator shall discuss the effects that further Timber Operations will have on the specific resources identified in 14 CCR §§ 916.8(a)(3), 936.8(a)(3), 956.8(a)(3) which are at risk within the nominated watershed and specify those effects not sufficiently addressed under the forest practice Rules and discuss the significance of the effects in light of the condition of the resources in areas adjacent to the planning watershed. Such nominations must be accompanied by the following information, descriptions, documents, or maps as appropriate:

1. Name, approximate size and location of the watershed(s) identified by county, township and range, and name(s) of USGS topographic map(s) on which the planning watershed is found.
2. The name of the higher-order Stream, if any, to which the watershed is tributary.
3. Specific resources that are significantly threatened by further Timber Operations on non-federal Timberland in the nominated watershed, including, as appropriate, but not limited to:
 - A. Fish, aquatic organisms, aquatic habitat, or Riparian habitat;
 - B. Domestic and other water supplies, water quality, other beneficial uses of water existing at the time of nomination or factors related to the Stream system and channel morphology.
 - C. Downstream reservoirs, navigable channels, water diversion and transport facilities, estuaries, and harbors;
 - D. Wildlife species, or the habitat of species, listed under state or federal law as rare, threatened or endangered, candidate, or sensitive, including discussion of the habitat features threatened by Timber Operations;
 - E. Wildlife species with narrow geographic range, low density, low reproductive rates, and highly dependent on localized habitat features, including discussion of the habitat features threatened by Timber Operations and a discussion of why protective measures are required to prevent a loss of population viability.
4. Natural or management-induced conditions present in the watershed which pose a significant threat to the resources identified in 14 CCR §§ 916.8(a)(3), 936.8(a)(3), 956.8(a)(3), above, including, as appropriate, but not limited to:
 - A. Steep slopes and easily destabilized soils;
 - B. Continuing landslide or soil erosion problems related to past or ongoing land-use activities;
 - C. Extensive ground disturbance, particularly associated with roads, skid trails, Landings, and Watercourse crossings;
 - D. Accelerated aggradation, Streambank erosion, and channel scouring;
 - E. Changes in the habitat or condition of wildlife species identified in 14 CCR §§ 916.8(a)(3), 936.8(a)(3), 956.8(a)(3), above.
 - F. Accelerated rates of proposed road construction or timber harvesting within a watershed or near Streams or springs.
5. Approved Habitat Conservation Plans or other documents approved or under review by public agencies within the nominated watershed which provide for maintenance or improvement over time of management induced conditions within or adjacent to the planning watershed or forest district.
6. Suggested, feasible mitigation measures needed, in addition to current forest practice Rules, to provide adequate protection for resources identified in 14 CCR §§ 916.8(a)(3), 936.8(a)(3), 956.8(a)(3),

CALIFORNIA FOREST PRACTICE RULES

above, and to mitigate or avoid new or continuing significant cumulative effects related to Timber Operations, including, but not limited to, restoration or rehabilitation of degraded resources within any portion of the proposed sensitive watershed.

7. Other information about the watershed that may assist the Board to evaluate the nomination.

8. Literature citations, expert written opinion, and other relevant sources of information and, where possible, copies of information used to complete the nomination.

9. A list of names and mailing addresses of the following:

A. Landowners of 40 acres or more of lands zoned for timber production in the planning watershed;

B. Public water purveyors and known private purveyors within the planning watershed;

C. Commonly known watershed associations within the planning watershed;

D. Commonly known neighborhood or community associations within the planning watershed;

E. Chairman, county board of supervisors;

F. Chairman, county planning commission;

G. Local manager for any public agency having custodial responsibility for Timberlands within the planning watershed; and

H. District or local representatives for review team agencies.

10. A draft notice for newspaper publication containing the information in (a)(1)-(3), a statement that a public hearing will be scheduled before the Board within 60 days of Board receipt of a nomination forwarded by the committee, and a statement that further information can be obtained from the local Department Unit Headquarters.

(b) Notice Process: The Board shall mail notice of the nominated watershed, as provided in (a)10, to the addresses of parties described in 9 A-H and shall publish the provided notice one time in a newspaper with general circulation in the county containing the planning watershed. Such notice shall be provided following a determination that information contained in the nomination meets the requirements of 14 CCR §§ 916.8(a), 936.8(a), 956.8(a), above.

(c) Screening Process: Before consideration by the Board, nominations shall be screened for compliance with the informational requirements by a nominations review committee, which may consist of the appropriate District Technical Advisory Committee or other Board Committee, as determined by the Board. The nominations review committee shall consult with CAL FIRE, the appropriate RWQCB, the CDFW, the CGS, and other(s) as deemed necessary to determine whether the nomination is supported by substantial evidence. The nominations review committee shall then forward a recommendation for approval or denial of the nomination to the Board within 120 days of the date of receipt by the committee, or such longer time provided by the Board. The nominations review committee shall describe its specific reason(s) for recommending approval or denial of the nomination. In the event that the committee forwards a recommendation for approval, it shall describe the substantial evidence which supports nomination, including specific reasons why the current forest practice Rules are inadequate to protect the specific resources at risk and shall provide the following information:

1. A list of which resource is threatened and by which Timber Operations;

2. If possible, performance standard(s) for Timber Operations that will avoid or mitigate new or continuing significant cumulative effects;

3. Additional information that is needed for evaluating the Impacts of proposed Timber Operations and is to be included in harvesting plans submitted in the planning watershed;

4. On-site mitigation measures in addition to the current forest practice Rules, which can be required by the Director to mitigate the Impacts of Timber Operations within the watershed;

5. Offsite mitigation measures that can be applied within or outside of the sensitive watershed area to offset adverse on-site Impacts of Timber Operations. If such mitigation measures are proposed to protect the resource discussed in subdivision (a)(3)(A) and (B), they must occur in the same drainage. Such measures may include, but are not limited to, voluntary mitigation agreements among ownerships.

6. If needed, recommended alternatives to evaluate the implementation and effectiveness of mitigations required under this section.

7. Exemptions for ownerships, emergencies, or land-use classifications that are different than those

CALIFORNIA FOREST PRACTICE RULES

provided in the current forest practice regulations and that may be applied in the watershed.

(d) Public hearing Process: The Board shall consider the recommendations of the nominations review committee at a public hearing on classification of the planning watershed, which will be held within 60 days of receipt from the committee. The watershed nomination and recommendations of the committee will be made available to the public between the date of receipt by the Board and the public hearing.

Recommendations adopted by the Board which have the effect of a regulation shall be processed in accordance with the Administrative Procedures Act (Gov. Code § 11340. et seq.).

916.9, 936.9, 956.9 Protection and Restoration of the Beneficial Functions of the Riparian Zone in Watersheds with Listed Anadromous Salmonids. [All Districts]

In addition to all other Rules, the following requirements shall apply in any watershed with listed anadromous salmonids. Requirements of 14 CCR §§ 916.9, 936.9, 956.9 precede other sections of the FPRs.

Geographic scope - Requirements for watersheds with listed anadromous salmonids differ depending on the geographic location of the watershed and geomorphic characteristics of the Watercourse. Unique requirements for watersheds with listed anadromous salmonids are set forth for 1) Watercourses in the coastal anadromy zone with confined channels, 2) Watercourses with flood prone areas or Channel Migration Zones, and 3) Watercourses with confined channels located outside the coastal anadromy zone.

Watersheds which do not meet the definition of “watersheds with listed anadromous salmonids” are not subject to this section except as follows: The provisions of 14 CCR §§ 916.9 [936.9, 956.9], subsections (k)-(q) also apply to planning watersheds immediately upstream of, and contiguous to, any watershed with listed anadromous salmonids for purposes of reducing significant adverse Impacts from transported fine sediment. Projects in other watersheds further upstream that flow into watersheds with listed anadromous salmonids, not otherwise designated above, may be subject to these provisions based on an assessment consistent with cumulative Impacts assessment requirements in 14 CCR §§ 898 and 912.9 [932.9, 952.9] and Technical Rule Addendum No. 2, Cumulative Impacts Assessment. These requirements do not apply to upstream watersheds where permanent dams attenuate the transport of fine sediment to downstream Watercourses with listed anadromous salmonids.

(a) Goal - Every timber operation shall be planned and conducted to protect, maintain, and contribute to restoration of properly functioning salmonid habitat and listed salmonid species. To achieve this goal, every timber operation shall be planned and conducted to:

- (1) Comply with the terms of a Total Maximum Daily Load (TMDL).
- (2) Prevent significant sediment load increase to a Watercourse system or lake.
- (3) Prevent significant instability of a Watercourse channel or of a Watercourse or lake bank.
- (4) Prevent significant blockage of any aquatic migratory routes for any life stage of anadromous salmonids or listed species.
- (5) Prevent significant adverse effects to streamflow.
- (6) Consistent with the requirements of 14 CCR § 916.9 [936.9, 956.9], subsections (f), (g), (h) and (v), protect, maintain, and restore trees (especially conifers), snags, or downed large woody debris that currently, or may in the foreseeable future, provide large woody debris recruitment needed for instream habitat structure and fluvial geomorphic functions.
- (7) Consistent with the requirements of 14 CCR § 916.9 [936.9, 956.9], subsections (f), (g), (h) and (v), protect, maintain, and restore the quality and quantity of vegetative canopy needed to:
 - (A) provide shade to the Watercourse or lake to maintain daily and seasonal water temperatures within the preferred range for anadromous salmonids or listed species where they are present or could be restored; and
 - (B) provide a deciduous vegetation component to the Riparian zone for aquatic nutrient inputs.
- (8) Prevent significant increases in peak flows or large flood frequency.

(b) Pre-plan adverse cumulative watershed effects - Pre-plan adverse cumulative watershed effects on the populations and habitat of anadromous salmonids shall be considered. The plan shall specifically acknowledge or refute that such effects exist. When the proposed Timber Operations, in combination with

CALIFORNIA FOREST PRACTICE RULES

any identified pre-plan watershed effects, will add to significant adverse existing cumulative watershed effects, the plan shall set forth measures to effectively reduce such effects.

(c) Objectives for Timber Operations or silvicultural prescriptions in WLPZs - Any timber operation or silvicultural prescription within any Watercourse or lake protection zone shall have protection, maintenance, or restoration of the beneficial uses of water, and properly functioning salmonid habitat and listed aquatic or Riparian-associated species as significant objectives. Specific objectives are described below.

(1) Core Zone: The primary objective for this zone is streamside bank protection to promote bank stability, wood recruitment by bank erosion, and canopy retention. Timber Operations are generally excluded from this zone and limited to actions which meet the objectives stated above or improve salmonid habitat consistent with 14 CCR § 916.9 [936.9, 956.9] subsections (a) and (c).

(2) Inner Zone: The primary objective for this zone is to develop a large number of trees for large wood recruitment, to provide additional shading, to develop vertical structural diversity, and to provide a variety of species (including hardwoods) for nutrient input. This is accomplished through the establishment of high basal area and canopy retention by retaining or more rapidly growing a sufficient number of large trees. Additional specific objectives include locating large trees retained for wood recruitment nearer to the Core Zone and maintaining or improving salmonid habitat on flood prone areas and CMZs when present. Timber Operations within WLPZs are limited to those actions which meet the objectives stated above or to improve salmonid habitat consistent with 14 CCR § 916.9 [936.9, 956.9] subsection (a) and (c).

(3) Outer Zone: The primary objective for this zone is to buffer the Inner and Core Zones and to provide the following functions: 1) wind resistance where windthrow is common or likely to occur, 2) additional wood recruitment, 3) microclimate control in the Inner or Core Zones for purposes other than limiting water temperature change, 4) habitat for terrestrial wildlife species that depend on Riparian areas, and 5) an additional sediment filter on steeper slopes with high or moderate erosion hazard rating when tractor operations are proposed.

(4) Class II Large Watercourses (Class II-L): The primary objective is to maintain, protect or restore the values and functions of Class II-L type Watercourses described below. Class II-L Watercourses can have greater individual effects on receiving Class I Watercourse temperature, sediment, nutrient, and large wood loading than Class II standard (Class II-S) Watercourses due to larger channel size, greater magnitude and duration of flow, and overall increased transport capacity for watershed products. Other objectives stated in 14 CCR § 916.9 [936.9, 956.9] subsections (c)(1) and (2) above for the Core Zone and Inner Zone are also desired objectives for Class II-L type Watercourses.

(5) A primary objective for all WLPZs is to implement practices to maintain, protect and contribute to restoration of properly functioning salmonid habitat and repair conditions detrimental to the species or species habitat. Practices to meet this objective include, but are not limited to, thinning for increased conifer growth; felling or Yarding trees for wood placement in the channel; restoration of conifer deficient areas; management to promote a mix of conifers and hardwoods; Abandonment and upgrading of non-functioning or high risk roads, Watercourse crossings, tractor roads, and Landings; and fuel hazard reduction activities that will reduce fire hazards and stand replacing wildfires which would result in significant adverse effects to salmonid species or Riparian habitat.

(d) Measures to Offset Adverse Watershed Effects –

(1) The plan shall fully describe: (A) the type and location of each measure needed to fully offset sediment loading, thermal loading, and potential significant adverse watershed effects from the proposed Timber Operations, and (B) the person(s) responsible for the implementation of each measure, if other than the Timber Operator.

(2) In proposing, reviewing, and approving such measures, preference shall be given to the following: (A) measures that are both onsite (i.e., on or near the plan area) and in-kind (i.e., erosion control measures where sediment is the problem), and (B) sites that are located to maximize the benefits to the Impacted portion of a Watercourse or lake. Out-of-kind measures (i.e., improving shade where sediment is the problem) shall not be approved as meeting the requirements of this subsection.

(e) Channel Zone requirements

(1) There shall be no Timber Operations within the Channel Zone with the following exceptions:

(A) Actions directed to improve salmonid habitat with review and concurrence by CDFW.

CALIFORNIA FOREST PRACTICE RULES

(B) Actions necessary for the construction, reconstruction, removal, or Abandonment of approved Watercourse crossings.

(C) Actions necessary for the protection of public health, safety and general welfare. This includes actions necessary to protect infrastructure facilities including, but not limited to, roads, bridges, powerlines, utilities, water drafting structures, homes, and other Approved and Legally Permitted Structures.

(D) Actions to allow for full suspension Cable Yarding when necessary to transport logs through the Channel Zone.

(E) Class III Watercourses consistent with 14 CCR § 916.9 [936.9, 956.9] subsection (h)(7).

(F) Actions reviewed by the RWQCB which seek to correct or remediate adverse Impacts to the beneficial uses of water.

(2) In all instances where trees are proposed to be felled within the Channel Zone, a base mark shall be placed below the cut line of the harvest trees within the zone. Such marking shall be completed by the RPF that prepared the plan, or a supervised designee, prior to the preharvest inspection.

(f) Class I Watercourses –

(1) For Class I Watercourses, where fish are always or seasonally present or where fish habitat is restorable, any plan involving Timber Operations within the WLPZ shall contain the following information:

(A) Clear and enforceable specifications of Timber Operations within the Class I WLPZ, including a description of how any disturbance, or log or tree cutting and removal shall be carried out to conform with 14 CCR §§ 916.2 [936.2, 956.2], subsection (a) and 916.9 [936.9, 956.9], subsection (a).

(B) Documentation of how proposed harvesting in the WLPZ contributes to the objectives of each zone stated in 14 CCR § 916.9 [936.9, 956.9], subsection (c) and other goals in 14 CCR § 916.9 [936.9, 956.9], subsection (a)(1)-(8). Documentation shall include the examinations, analysis, and other requirements listed in 14 CCR § 916.4 [936.4, 956.4], subsection (a).

(2) Class I Watercourses with confined channels in watersheds in the coastal anadromy zone:

The following are the minimum requirements for WLPZ delineation and Timber Operations in Class I WLPZs in watersheds in the coastal anadromy zone where confined channels are present. WLPZ width ranges from 100-150 feet slope distance, depending on the silvicultural system applied above the WLPZ. Three Zones are established within the WLPZs: The Core Zone is nearest to the water, the Inner Zone is the middle zone contiguous to the Core Zone, and the Outer Zone is furthest from the water and contiguous to the Inner Zone. Graphic depictions of zones and the abbreviated descriptions of the silvicultural prescriptions and operational requirements are shown in Figure 5. Table 1 specifies the enforceable standards to be used for protection of Class I Watercourses for the area included in the coastal anadromy zone:

(A) **Core Zone:** The minimum width of the Core Zone shall be 30 feet measured from the Watercourse Transition Line or Lake Transition Line. No Timber Operations are permitted in this zone except for those listed in 14 CCR § 916.9 [936.9, 956.9], subsection (e)(1)(A)-(F), or those approved pursuant to 14 CCR § 916.9 [936.9, 956.9], subsection (v). Sanitation-Salvage is prohibited except as provided in 14 CCR § 916.9 [936.9, 956.9], subsections (s), (t), and (u).

(B) **Inner Zone:** The minimum width of the Inner zone shall be 70 feet measured from the landward edge of Core Zone. Timber Operations are permitted in this zone when conducted to meet the goals of this section, objectives for the Inner Zone in 14 CCR § 916.9 [936.9, 956.9], subsection (c)(2), pursuant to 14 CCR § 916.9 [936.9, 956.9], subsections (e) (1)(A)-(F), or pursuant to 14 CCR § 916.9 [936.9, 956.9], subsection (v). Harvesting prescriptions should focus on practices that use thinning from below. Silvicultural systems for harvesting are limited to the use of commercial thinning or single tree selection modified to meet the following requirements:

1. When commercial thinning is used, the QMD of conifer trees greater than 8 inches dbh in the preharvest project area shall be increased in the postharvest stand.

2. Sanitation-Salvage is prohibited except as provided in 14 CCR § 916.9 [936.9, 956.9], subsections (s), (t), and (u).

3. Postharvest stand shall have a minimum 80% overstory canopy cover in the Coast and Southern Forest Districts of the coastal anadromy zone and a minimum 70% overstory canopy cover in the Northern Forest District of the coastal anadromy zone. The postharvest canopy may be

CALIFORNIA FOREST PRACTICE RULES

composed of both conifers and hardwood species and shall have at least 25% overstory conifer canopy.

4. Postharvest stand shall retain the 13 largest conifer trees (live or dead) on each acre of the area that encompasses the Core and Inner Zones.

5. Large trees retained to meet 14 CCR § 916.9 [936.9, 956.9], subsections (f)(2)(B)(1.) and (3.) above that are the most conducive to recruitment to provide for the beneficial functions of Riparian zones (e.g., trees that lean towards the channel, have an unimpeded fall path toward the Watercourse, are in an advanced state of decay, are located on unstable areas or downslope of such unstable areas, or have undermined roots) are to be given priority to be retained as future recruitment trees.

(C) Outer Zone: The minimum width of the Outer Zone shall be 50 feet measured from the landward edge of Inner Zone. This zone is required where evenaged regeneration methods, seed tree removal, shelterwood removal, alternative prescriptions declared under 14 CCR § 913.6 [933.6, 953.6], subsection (b)(3) as most related to any evenaged silvicultural system, variable retention or rehabilitation of understocked areas will be utilized contiguous to the Watercourse and lake protection zone. Timber Operations are permitted in this zone when conducted to meet the goals of this section, including those for the Outer Zone in 14 CCR § 916.9 [936.9, 956.9], subsection (c)(3), and (5), pursuant to 14 CCR § 916.9 [936.9], subsection (e)(1)(A)-(F), or pursuant to 14 CCR § 916.9 [936.9, 956.9], subsection (v). Silvicultural systems for harvesting are limited to the use of commercial thinning or single tree selection modified to meet the following requirements:

1. Postharvest stand shall have a minimum 50% overstory canopy cover. The postharvest canopy may be composed of both conifers and hardwood species and shall have at least 25% overstory conifer canopy.

2. Priority shall be given to retain wind firm trees.

(D) Preferred Management Practices in the Inner and Outer Zones: When Timber Operations are considered pursuant to 14 CCR §§ 916.3 [936.3, 956.3], subsection (c) and 916.4 [936.4, 956.4], subsection (d), the following Preferred Management Practices should be considered for inclusion in the Plan by the RPF and by the Director:

1. Preflagging or marking of any skid trails before the preharvest inspection;

2. Heavy equipment should be limited to slopes less than 35% with low or moderate

EHR;

3. Use feller bunchers or hydraulic heel boom loaders which do not drag/skid logs

through the zone;

4. Minimize turning of heavy equipment which would result in increased depth of

ground surface depressions; and

5. Use mechanized harvesting equipment which delimb harvested trees on pathway

over which heavy equipment would travel.

(E) Additional Special Operating Zone: For situations contiguous to the Outer Zone where evenaged regeneration methods, seed tree removal step, shelterwood removal step, alternative prescriptions declared under 14 CCR § 913.6 [933.6, 953.6], subsection (b)(3) as most related to any evenaged silvicultural system, variable retention or rehabilitation of understocked areas with the same effect as a clearcut is used, slopes are greater than 50%, and the Outer Zone is located on any north aspect, the RPF shall consider the need for a special operating zone for purposes of shading the Watercourse from direct low angle solar radiation from beneath the overstory canopy that is expected to have a potential significant adverse Impact on water temperature. When the special operating zone is needed, the special operating zone shall retain understory and mid-canopy conifers and hardwoods. These trees shall be protected during falling, Yarding and Site Preparation to the extent feasible. Width of the zone shall be 50 feet measured from the landward edge of the Outer Zone.

CALIFORNIA FOREST PRACTICE RULES

**Table 1: Procedure for Determining WLPZ Widths and Protective Measures
Class I WLPZs - Confined Channels - Coastal Anadromy Zone**

Pursuant to 14 CCR 916.9[936.9,956.9](f)(2)						
Zone Designation	Zone width (ft.)	Overstory Canopy Cover		Large Tree Retention	Silviculture Requirements	Operational Requirements
Channel Zone	Variable	Retain all trees except per 916.9 [936.9, 956.9](e)(1) A-F or 916.9 [936.9 956.9] (v)		Retain all trees except per 916.9 [936.9, 956.9](e) (1) A-F or 916.9 [936.9 956.9] (v)	Retain all trees except per 916.9 [936.9, 956.9] (e) (1) A-F or 916.9 [936.9, 956.9](v)	No Timber Operations except per 916.9 [936.9, 956.9] (e) (1)A-F or 916.9 [936.9, 956.9](v);
Core Zone per 916.9 [936.9 956.9] (f)(2)(A)	30 ft.	Retain all trees except per 916.9 [936.9, 956.9](e) (1)A-F or 916.9 [936.9 956.9] (v)		Retain all trees except per 916.9 [936.9, 956.9](e)(1) A-F or 916.9 [936.9 956.9] (v)	Retain all trees except per 916.9 [936.9, 956.9] (e) (1) A-F or 916.9 [936.9, 956.9](v); no sanitation salvage except 916.9 (s)(t)and (u).	No Timber Operations except per 916.9 [936.9, 956.9] (e) (1) A-F or 916.9 [936.9, 956.9](v);
Inner Zone per 916.9 [936.9 956.9] (f)(2)(B)	70 ft.	80% Coast and Southern Forest District of Coastal Anadromy Zone per 916.9 [936.9 956.9] (f)(2)(B)3.	70% in Northern Forest District of Coastal Anadromy Zone per 916.9 [936.9 956.9] (f)(2)(B)3.	13 largest trees /ac. per 916.9 [936.9 956.9] (f)(2)(B)4.	Increase QMD; No sanitation salvage except 916.9 (s)(t)and (u); commercial thinning or single tree selection only.	Preferred Management Practices in 916.9 [936.9, 956.9] (f)(2)(D)
Outer Zone per 916.9 [936.9 956.9] (f)(2)(C) Outer Zone applicable only where even-aged regeneration used adjacent to the WLPZ	50 ft.	50% per 916.9 [936.9 956.9] (f)(2)(C).1.		NA	Commercial thinning or single tree selection only; Retain wind firm trees.	Preferred Management Practices in 916.9 [936.9, 956.9] (f)(2)(D)
Special Operating Zone per 916.9 [936.9 956.9] (f)(2)(E)	50 ft.	NA		NA	SOZ applicable only where even-aged regeneration used adjacent to the WLPZ . Retain understory and midstory trees per 916.9 [936.9, 956.9] (f)(2)(E)	All other Forest Practice Rules

CALIFORNIA FOREST PRACTICE RULES

Figure 4: Graphic of profile view of Class I WLPZ with confined channels in watersheds in the coastal anadromy zone (not to scale)

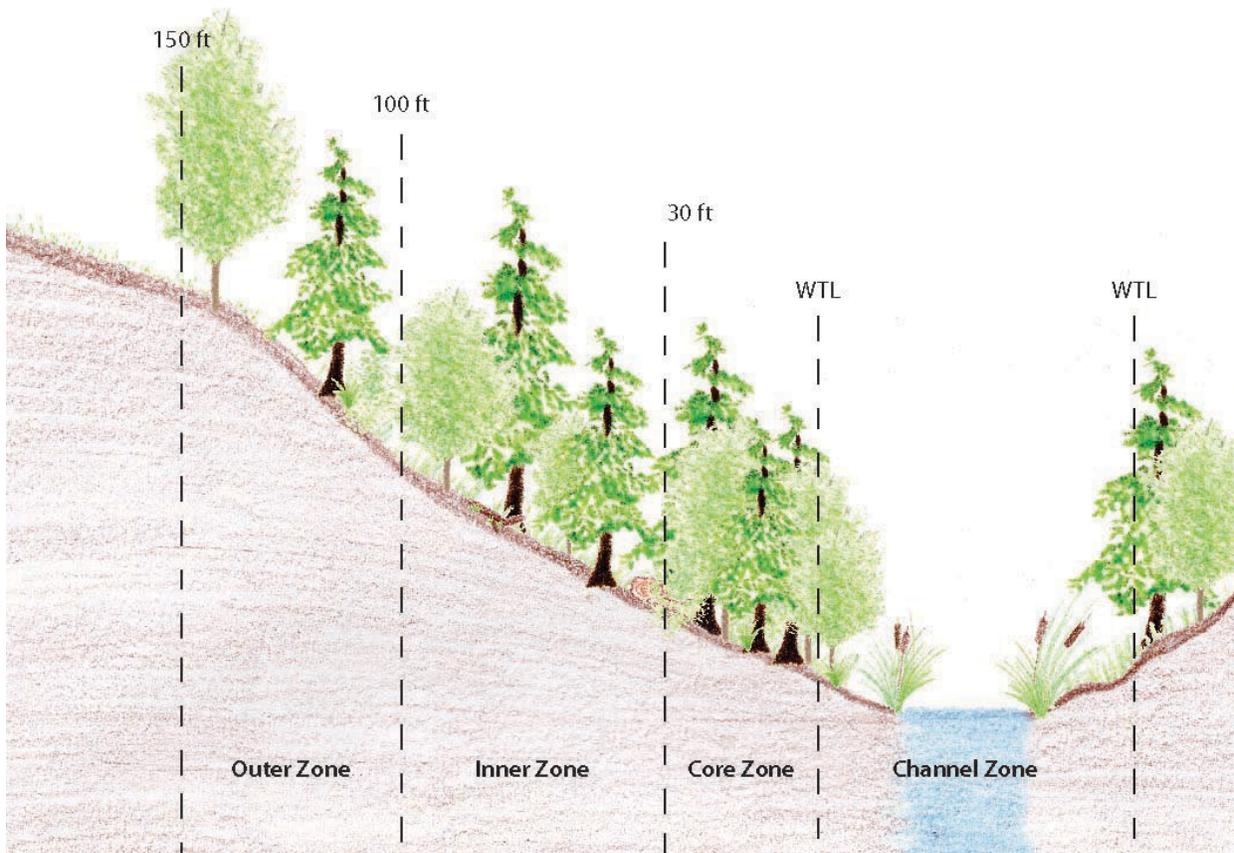

Outer Zone:

50 ft. Outer Zone required only when even aged silv. system contiguous to WLPZ
Modified commercial thinning or single tree selection
50% overstory canopy (OSC)

Inner Zone:

Modified commercial thinning or single tree selection
Increase QMD
No Sanitation Salvage
Retain 80% OSC in the Coast and Southern Forest Districts of the coastal anadromy zone and
70% OSC in the Northern Forest District of the coastal anadromy zone
Retain 13 largest trees/ac.

CALIFORNIA FOREST PRACTICE RULES

(3) Class I Watercourses with flood prone areas or Channel Migration Zones: The following are the minimum requirements for WLPZ delineation and Timber Operations in Class I WLPZs in locations where flood prone areas and/or CMZs are present. WLPZ widths vary depending on the extent of the flood prone area and silvicultural system applied contiguous to the WLPZ.

There are up to 5 zones established within the WLPZ: The CMZ (when present), the Core Zone is the portion of the flood prone area nearest the water (and contiguous to the CMZ when present), the Inner Zone A is contiguous to the Core Zone, the Inner Zone B is contiguous to the Inner Zone A and extends to the landward edge of the flood prone area, and the Outer Zone is the hillslope area and is contiguous to the Inner Zone B and landward perimeter of the flood prone area. Table 2 specifies the enforceable standards to be used for protection of Class I Watercourses with flood prone areas or Channel Migration Zones. The zones and the abbreviated descriptions of the silvicultural prescriptions, and operational requirements are shown in Figure 6.

(A) Channel Migration Zone: When a CMZ is present, no Timber Operations are permitted in this zone except for those listed in § 916.9 [936.9, 956.9], subsection (e)(1)(A)-(F), or pursuant to 14 CCR § 916.9 [936.9, 956.9], subsection (v).

(B) Core Zone: The minimum width of the Core Zone shall be 30 feet measured from the Watercourse Transition Line or Lake Transition Line. No Timber Operations are permitted in this zone except for those listed in 14 CCR § 916.9 [936.9, 956.9], subsection (e)(1)(A)-(F), or those approved pursuant to 14 CCR § 916.9 [936.9, 956.9], subsection (v). Sanitation-Salvage is prohibited except as provided in 14 CCR § 916.9 [936.9, 956.9], subsections (s), (t), and (u).

(C) Inner Zone A: The Inner Zone A generally encompasses the portion of the flood prone area from 30 feet beyond the WTL (Core Zone perimeter) up to 150 feet from the WTL. The minimum width of the Inner Zone A shall be the greater of the distance from the landward edge of the Core Zone to the landward edge of the Inner Zone A or 70 feet. The maximum width is 120 feet. Timber Operations are permitted in this zone when conducted to meet the goals of this section, including those for the Inner Zone in 14 CCR § 916.9 [936.9, 956.9], subsection (c)(2), pursuant to 14 CCR § 916.9 [936.9, 956.9], subsections (e)(1)(A)-(F) or pursuant to 14 CCR § 916.9 [936.9, 956.9], subsection (v). Harvesting prescriptions should focus on practices that use thinning from below. Silvicultural systems for harvesting are limited to the use of commercial thinning or single tree selection modified to meet the following requirements:

1. When commercial thinning is used, the QMD of conifer trees greater than 8 inches dbh in the preharvest project area shall be increased in the postharvest stand.
2. Sanitation-Salvage is prohibited except as provided in 14 CCR § 916.9 [936.9, 956.9], subsections (s), (t), and (u).
3. Postharvest stand shall have a minimum 80% overstory canopy cover in the Coast and Southern Forest Districts of the coastal anadromy zone and a minimum 70% overstory canopy cover in all other watersheds with listed anadromous salmonids. The postharvest canopy may be composed of both conifers and hardwood species and shall have at least 25% overstory conifer canopy.
4. Postharvest stand shall retain the 13 largest conifer trees (live or dead) on each acre of the area that encompasses the Core and Inner Zones.
5. Large trees retained to meet 14 CCR § 916.9 [936.9, 956.9], subsections (f)(3)(C)(1.) and (3.) above that are the most conducive to recruitment to provide for the beneficial functions of Riparian zones (e.g. trees that lean towards the channel, have an unimpeded fall path toward the Watercourse, are in an advanced state of decay, are located on unstable areas or downslope of such unstable areas, or have undermined roots) are to be given priority to be retained as future recruitment trees.

(D) Inner Zone B: The Inner Zone B is applicable when there are very wide flood prone areas. The Inner Zone B encompasses the portion of the flood prone area from the landward edge of the Inner Zone A (i.e., 150 feet from the WTL) to the landward edge of the flood prone area. The landward edge of the Inner Zone B (i.e., the landward perimeter of the flood prone area) shall be established in accordance with flood prone area definitions in 14 CCR § 895.1. Timber Operations are permitted in this zone when conducted to meet the goals of this section, including those for the Inner Zone in 14 CCR § 916.9 [936.9, 956.9], subsection (c)(2), 14 CCR § 916.9 [936.9, 956.9], subsection (e)(1)(A)-(F), or pursuant to 14 CCR § 916.9 [936.9, 956.9], subsection (v). Silvicultural systems for harvesting are limited to the use of commercial thinning or single tree selection modified to meet the following requirements:

CALIFORNIA FOREST PRACTICE RULES

1. Postharvest stand shall retain the 13 largest conifer trees (live or dead) on each acre of the area that encompasses the Core and Inner Zones.

2. Postharvest stand shall have a minimum 50% overstory canopy cover. The postharvest canopy may be composed of both conifers and hardwood species and shall have at least 25% overstory conifer canopy.

(E) Preferred Management Practices in the Inner Zone A and B of flood prone areas.

When Timber Operations are considered pursuant to 14 CCR §§ 916.3 [936.3, 956.3], subsection (c) and 916.4 [936.4, 956.4], subsection (d), the following Preferred Management Practices should be considered for inclusion in the Plan by the RPF and by the Director when Timber Operations are conducted in the Inner Zones of the flood prone area.

1. **Implement actions to improved salmonid habitat conditions:** Implement maintenance and repair actions that contribute to improving undesired existing conditions and contribute to restoring properly functioning salmonid habitat.

2. **Minimize Yarding and Skidding:** Skid trails, Yarding corridors, falling activities, and log Yarding should not alter the natural drainage or flow patterns. EEZ of 30 feet should be applied near side channels and areas of ponding. Very limited, pre-flagged, pre-approved prior to falling skid trails shall be used and abandoned so as to minimize risk of becoming new secondary channels by flood flows. Minimize or exclude, to the extent feasible, tractor Skidding/crossings over, through, or along secondary channels (protection of overflow channels is a key element). Locate tractor roads on high ground areas to the greatest extent possible. When feasible, use feller bunchers which do not drag/skid logs through the zone, minimize turning of equipment which would result in increased depth of ground surface depressions, and utilize mechanized harvesting equipment which delimbs harvested trees on the pathway over which equipment would travel. Cable Yarding corridors should be located at wide intervals consistent with practices that use lateral Yarding. Full suspension should be used when possible.

3. **Minimize Soil Erosion and Prevent Discharge:** Design Timber Operations to avoid turbid runoff by treating any ground disturbance greater than 100 square feet. Operations shall be conducted only in dry soil conditions. Avoid disturbance of vegetation not intended for harvest that could increase the likelihood of erosion or damages the reinforcing root network on the channel banks, including any secondary overflow channel. Restore any tracks or trails to an original surface.

4. **Avoid Slash concentration and Site Preparation:** Logging Slash shall not be disposed of or concentrated in side channels. When Slash is treated within the flood prone areas, scatter Slash and avoid piling or other concentrations that may obstruct flows in side channels. When feasible, concentrate/mulch Slash in tractor roads. No Mechanical Site Preparation, Broadcast Burning or pile burning.

5. **Delineate Zone on the Ground:** Locations of all WLPZ zones and CMZs shall be designated on the ground.

6. **Avoid Use of Water Drafting Sites:** Water drafting sites shall be located outside flood prone areas when feasible (exceptions could include, but are not limited to, drafting from an existing Watercourse crossing that is appropriately engineered to facilitate properly functioning salmonid habitat and those sites designed and permitted pursuant to a waste discharge or Stream alteration permits.

7. **Avoid Disturbance to Critical Flood Prone Area Habitat:** Avoid disturbance of abandoned meanders, oxbox lakes, or other features that provide off-channel habitat for fish during flood flows. Avoid activities that could increase potential for diversion or avulsion of Stream flow out of existing channel, including breaching or lowering the elevation of natural levees. Retain adequate hydraulic roughness provided by trees on the floodplain surface, thereby slowing flood water velocity on floodplains, attenuating peak flood flows, and allowing sediment to be deposited. Retain existing deciduous hardwoods preferential to anadromous salmonid species and down large woody debris.

(F) Outer Zone: The width of the Outer Zone is 50 feet measured from the landward edge of the Inner Zone. This zone is required where evenaged regeneration methods, seed tree removal, shelterwood removal, alternative prescriptions declared under 14 CCR §913.6 [933.6, 956.6], subsection (b)(3) as most related to any evenaged silvicultural system, variable retention or rehabilitation of understocked areas will be utilized contiguous to the Watercourse and lake protection zone. Timber Operations are permitted in this zone when conducted to meet the goals of this section, including those for

CALIFORNIA FOREST PRACTICE RULES

the Outer Zone in 14 CCR § 916.9 [936.9, 956.9], subsection (c)(3) and (5), pursuant to 14 CCR § 916.9 [936.9, 956.9] subsection (e)(1)(A)-(F), or pursuant to 14 CCR § 916.9 [936.9, 956.9], subsection (v). Silvicultural systems for harvesting are limited to the use of commercial thinning or single tree selection modified to meet the following requirements:

1. Postharvest stand shall have a minimum 50% overstory canopy cover. The postharvest canopy may be composed of both conifers and hardwood species and shall have at least 25% overstory conifer canopy.

2. Priority shall be given to retain wind firm trees.

(4) Class I Watercourses with confined channels outside watersheds in the coastal anadromy zone: The following are the minimum requirements for WLPZ delineation and Timber Operations in Class I WLPZs in locations outside of watersheds in the coastal anadromy zone where confined channels are present. WLPZ width is 100 feet slope distance, with an additional 25 foot ELZ depending on the silvicultural system applied contiguous to the WLPZ. Three zones are established within the WLPZs: The Core Zone is nearest to the water, the Inner Zone is the middle zone contiguous to the Core Zone, and the Outer Zone is furthest from the water and contiguous to the Inner Zone. Graphic depiction of the zones and the abbreviated descriptions of the silvicultural prescriptions and operational requirements are shown in Figure 7. Table 3 specifies the enforceable standards to be used for protection of Class I Watercourses for the area outside the coastal anadromy zone:

(A) Core Zone: The minimum width of the Core Zone shall be 30 feet measured from the Watercourse Transition Line or Lake Transition Line. No Timber Operations are permitted in this zone except for those listed in 14 CCR § 916.9 [936.9, 956.9], subsection (e)(1)(A)-(F), or those approved pursuant to 14 CCR § 916.9 [936.9, 956.9], subsection (v). Sanitation-Salvage is prohibited except as provided in 14 CCR § 916.9 [936.9, 956.9], subsections (s), (t), and (u).

(B) Inner Zone: The minimum width of the Inner Zone shall be 40 feet measured from the landward edge of Core Zone. Timber Operations are permitted in this zone when conducted to meet the goals of this section, including those for the Inner Zone in 14 CCR § 916.9 [936.9, 956.9], subsection (c)(2), pursuant to 14 CCR § 916.9 [936.9, 956.9], subsections (e)(1) (A)-(F) or pursuant to 14 CCR § 916.9 [936.9, 956.9], subsection (v). Harvesting prescriptions should focus on practices that use thinning from below. Silvicultural systems for harvesting are limited to the use of commercial thinning or single tree selection modified to meet the following requirements:

1. When commercial thinning is used, the QMD of conifer trees greater than 8 inches dbh in the preharvest project area shall be increased in the postharvest stand.

2. Sanitation-Salvage is prohibited except as provided in 14 CCR § 916.9 [936.9, 956.9], subsections (s), (t), and (u).

3. Postharvest stand shall have a minimum 70% overstory canopy cover. The postharvest canopy may be composed of both conifers and hardwood species and shall have at least 25% overstory conifer canopy.

4. Postharvest stand shall retain the 7 largest conifer trees (live or dead) on each acre of the area that encompasses the Core and Inner Zones.

5. Large trees retained to meet 14 CCR § 916.9 [936.9, 956.9], subsections (f)(4)(B)(1.) and (3.) above that are the most conducive to recruitment to provide for the beneficial functions of Riparian zones (e.g., trees that lean towards the channel, have an unimpeded fall path toward the Watercourse, are in an advanced state of decay, are located on unstable areas or downslope of such unstable areas, or have undermined roots) are to be given priority to be retained as future recruitment trees.

(C) Outer Zone: The minimum width of the Outer Zone shall be 30 feet measured from the landward edge of the Inner Zone. When evenaged regeneration methods, seed tree removal, shelterwood removal, alternative prescriptions declared under 14 CCR § 913.6 [933.6, 953.6], subsection (b)(3) as most related to any evenaged silvicultural system, variable retention, or rehabilitation will be utilized contiguous to Watercourse and lake protection zones, an additional 25 foot ELZ is required contiguous to the Outer Zone. Timber Operations are permitted in the Outer Zone when conducted to meet the goals of this section, including those for the Outer Zone in 14 CCR § 916.9 [936.9, 956.9], subsection (c)(3) and (5) pursuant to 14 CCR § 916.9 [936.9, 956.9], subsection (e)(1)(A)-(F), or pursuant to 14 CCR § 916.9 [936.9, 956.9],

CALIFORNIA FOREST PRACTICE RULES

Table 2: Procedure for Determining WLPZ Widths and Protective Measures Class I WLPZs – with flood prone areas or channel migration zones						
Pursuant to 14 CCR 916.9 [936.9, 956.9] (f)(3)						
Zone Designation	Zone width (ft.)	Overstory Canopy Cover		Large Tree Retention	Silviculture Requirements	Operational Requirements
Channel Zone or Channel Migration Zone per 916.9 [936.9 956.9] (f)(3)(A)	Variable	Retain all trees except per 916.9 [936.9, 956.9](e) (1)A-F or 916.9 [936.9 956.9] (v)		Retain all trees except per 916.9 [936.9, 956.9](e) (1)A-F or 916.9 [936.9 956.9] (v)	Retain all trees except per 916.9 [936.9, 956.9] (e) (1) A-F or 916.9 [936.9, 956.9](v)	No Timber Operations except per 916.9 [936.9, 956.9] (e)(1) A-F or 916.9 [936.9, 956.9](v);
Core Zone per 916.9 [936.9 956.9] (f)(3)(B)	30 ft.	Retain all trees except per 916.9 [936.9, 956.9](e) (1)A-F or 916.9 [936.9 956.9] (v)		Retain all trees except per 916.9 [936.9, 956.9](e) (1)A-F or 916.9 [936.9 956.9] (v)	Retain all trees except per 916.9 [936.9, 956.9] (e) (1) A-F or 916.9 [936.9, 956.9](v); no sanitation salvage except 916.9 (s)(t)and (u).	No Timber Operations except per 916.9 [936.9, 956.9] (e) (1)A-F or 916.9 [936.9, 956.9](v);
Inner Zone A per 916.9 [936.9 956.9] (f)(3)(C)	Minimum 70 ft. Maximum 120 ft.	80% Coast and Southern Forest District of Coastal Anadromy Zone per 916.9 [936.9 956.9] (f)(3)(C)3.	70% in all other watersheds per 916.9 [936.9 956.9] (f)(3)(C)3.	13 largest trees /ac. per 916.9 [936.9 956.9] (f)(3)(C)4.	Increase QMD; No sanitation salvage except 916.9 (s)(t)and (u); commercial thinning or single tree selection only.	Preferred Management Practices in 916.9 [936.9, 956.9] (f)(3)(E)
Inner Zone B per 916.9 [936.9 956.9] (f)(3)(D)	Variable: distance from Inner Zone A to end of FPA.	50%		13 largest trees /ac. per 916.9 [936.9 956.9] (f)(3)(D)1.	Increase QMD; No sanitation salvage except 916.9 (s)(t)and (u); commercial thinning or single tree selection only.	Preferred Management Practices in 916.9 [936.9, 956.9] (f)(3)(E)
Outer Zone per 916.9 [936.9 956.9] (f)(3)(F) Applicable only where even-aged regeneration used adjacent to the WLPZ	50 ft.	50%		NA	Commercial thinning or single tree selection only; Retain wind firm trees.	Preferred Management Practices in 916.9 [936.9, 956.9] (f)(3)(E)

CALIFORNIA FOREST PRACTICE RULES

Figure 5: Graphic of Profile View of Class I WLPZ in flood prone areas and channel migration zones (not to scale)

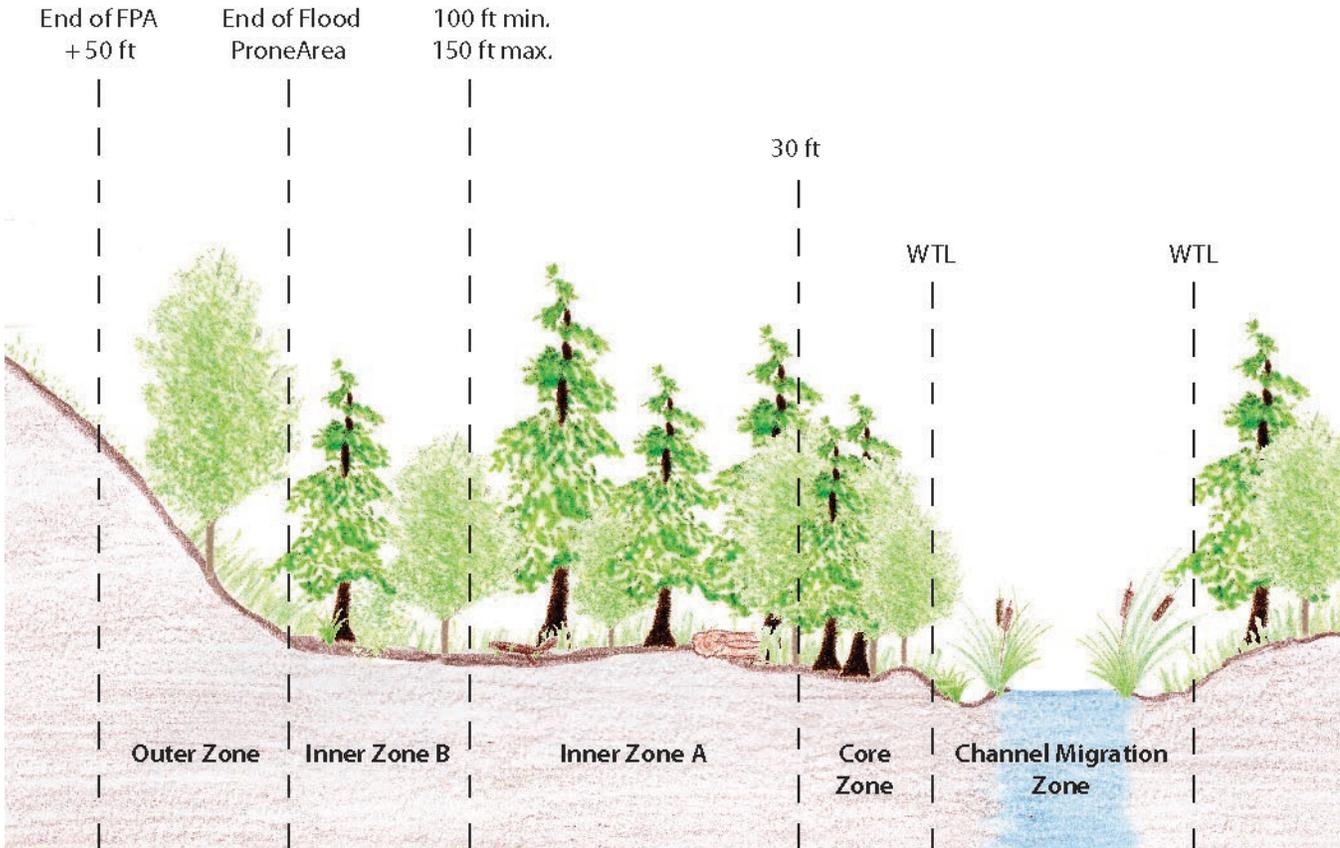

Outer Zone:

50 ft. Outer Zone required only when even aged silv. system contiguous to WLPZ
 Modified commercial thinning or single tree selection
 50% overstory canopy (OSC)

Inner Zone B:

Modified commercial thinning or single tree selection
 50% overstory canopy (OSC)
 Retain 13 largest trees/ac.

Inner Zone A:

Modified commercial thinning or single tree selection
 Increase QMD
 No Sanitation Salvage
 Retain 80% OSC in the Coast and Southern Forest Districts
 of the coastal anadromy zone and 70% OSC in all other watersheds
 Retain 13 largest trees/ac.

CALIFORNIA FOREST PRACTICE RULES

subsection (v). Silvicultural systems for harvesting are limited to the use of commercial thinning or single tree selection modified to meet the following requirements:

1. Postharvest stand shall have a minimum 50% overstory canopy cover. The

**Table 3: Procedure for Determining WLPZ Widths and Protective Measures
Class I WLPZs - Confined Channels - Outside the Coastal Anadromy Zone**

postharvest canopy may be composed of both conifers and hardwood species and

shall have at least 25% overstory conifer canopy.

2. Priority shall be given to retain wind firm trees.

(D) Preferred Management Practices in the Inner and Outer Zone:

When Timber Operations are considered pursuant to 14 CCR §§ 916.3 [936.3, 956.3], subsection (c) and 916.4 [936.4, 956.4], subsection (d), the following Preferred Management Practices should be considered for inclusion in the Plan by the RPF and by the Director:

1. Preflagging or marking of any skid trails before the preharvest inspection;
2. Heavy equipment should be limited to slopes less than 35% with low or moderate EHR;
3. Use feller bunchers or hydraulic heel boom loaders which do not drag/skid logs through the zone;
4. Minimize turning of heavy equipment which would result in increased depth of ground surface depressions; and
5. Use mechanized harvesting equipment which delimb harvested trees on pathway over which heavy equipment would travel.

(g) Class II Watercourses –

The following are the minimum requirements for Class II WLPZ delineation and Timber Operations. Differing Rules are specified for watersheds in the coastal anadromy zone, the Southern Subdistrict of the Coast Forest District, and areas outside the coastal anadromy zone. WLPZ width ranges from 50 to 100 feet slope distance, depending on side slope steepness in the WLPZ and the Watercourse type. Additional site-specific measures may be incorporated into the plan as necessary to protect beneficial uses of water relative to Riparian function pursuant to 14 CCR § 916.2(c), 916.4(a)(1), and 916.9 (b).

(1) Determine the Class II Watercourse Type: Class II Watercourses are composed of two types - Class II-S (standard) Watercourses and Class II-L (large) Watercourses. Class II-S Watercourses are those classified as Class II Watercourses pursuant to 14 CCR § 916.5 [936.5, 956.5], but do not possess the characteristics of a Class II-L Watercourse.

(A) A Class II-L Watercourse is defined as a Class II Watercourse having a contributing drainage area of ≥ 100 acres in the Coast Forest District, or ≥ 150 acres for the Northern and Southern Forest Districts, as measured from the confluence of the receiving Class I Watercourse.

(B) All Class II-L Watercourses shall incorporate requirements stated in 14 CCR § 916.9 [936.9, 956.9], subsection (g)(2) for a distance of one-thousand feet (1,000 ft.), or total length of Class II, whichever is less, as measured from the confluence with a Class I Watercourse. The RPF shall include the mapped location of Class II-L Watercourse segments receiving protections pursuant to 14 CCR § 916.9 [936.9, 956.9], subsection (g)(2) in the plan area. Where such Class II-L Watercourses branch prior to the end of the one-thousand foot (1,000 ft.) protection distance, the branch that meets or exceeds the drainage area standards of 14 CCR § 916.9 [936.9, 956.9], subsection (g)(1)(A) shall receive the remainder of the one-thousand foot (1,000 ft.) protection distance. If two or more branches meet or exceed the drainage area standards of 14 CCR § 916.9 [936.9, 956.9], subsection (g)(1)(A)1., then the remainder of the one-thousand foot (1,000 ft.) protection distance shall be applied to all branches exceeding the standard. If no individual branch exceeds the drainage area standards of 14 CCR § 916.9 [936.9, 956.9], subsection (g)(1)(A)1., then the single branch with the largest drainage area shall receive the remainder of the one-thousand foot (1,000 ft.) protection distance.

CALIFORNIA FOREST PRACTICE RULES

Pursuant to 14 CCR 916.9[936.9,956.9](f)(4)					
Zone Designation	Zone width (ft.)	Overstory Canopy Cover	Large Tree Retention	Silviculture Requirements	Operational Requirements
Channel Zone	Variable	Retain all trees except per 916.9 [936.9, 956.9](e)(1) A-F or 916.9 [936.9 956.9] (v)	Retain all trees except per 916.9 [936.9, 956.9](e)(1) A-F or 916.9 [936.9 956.9] (v)	Retain all trees except per 916.9 [936.9, 956.9] (e)(1) A-F or 916.9 [936.9, 956.9](v)	No Timber Operations except per 916.9 [936.9, 956.9] (e)(1) A-F or 916.9 [936.9, 956.9](v);
Core Zone per 916.9 [936.9 956.9] (f)(4)(A)	30 ft.	Retain all trees except per 916.9 [936.9, 956.9](e)(1) A-F or 916.9 [936.9 956.9] (v)	Retain all trees except per 916.9 [936.9, 956.9](e)(1) A-F or 916.9 [936.9 956.9] (v)	Retain all trees except per 916.9 [936.9, 956.9] (e)(1) A-F or 916.9 [936.9, 956.9](v); no sanitation salvage except 916.9 (s)(t)and (u).	No Timber Operations except per 916.9 [936.9, 956.9] (e)(1) A-F or 916.9 [936.9, 956.9](v);
Inner Zone per 916.9 [936.9 956.9] (f)(4)(B)	40 ft.	70% per 916.9 [936.9 956.9] (f)(4)(B)3.	7 largest trees /ac. per 916.9 [936.9 956.9] (f)(4)(B)4.	Increase QMD; No sanitation salvage except 916.9 (s)(t)and (u); commercial thinning or single tree selection only.	Preferred Management Practices in 916.9 [936.9, 956.9] (f)(4)(D)
Outer Zone per 916.9 [936.9 956.9] (f)(4)(C)1.	30 ft.	50% per 916.9 [936.9 956.9] (f)(4)(C)1.	NA	Commercial thinning or single tree selection only; Retain wind firm trees.	Preferred Management Practices in 916.9 [936.9, 956.9] (f)(4)(D)
ELZ Applicable only where even-aged regeneration used adjacent to the WLPZ	25 ft.	NA	NA	All other Forest Practice Rules	All other Forest Practice Rules

CALIFORNIA FOREST PRACTICE RULES

Figure 6: Graphic of profile view of Class I WLPZ with confined channels outside watersheds in the coastal anadromy zone (not to scale)

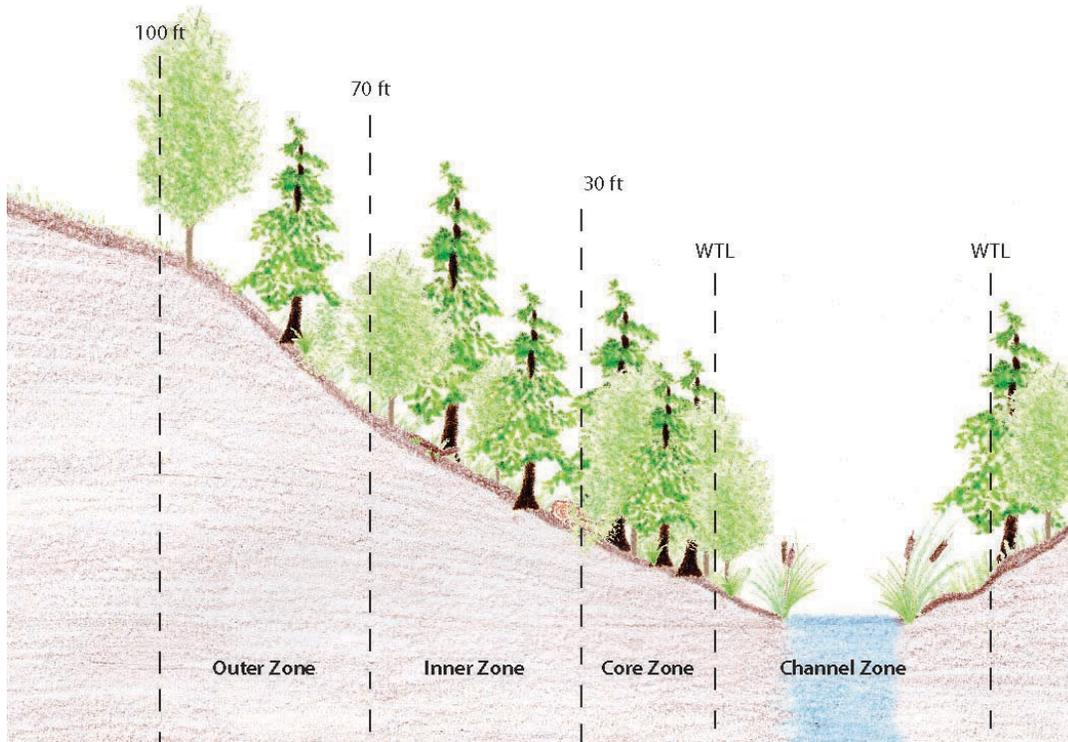

Outer Zone:

Modified commercial thinning or single tree selection
50% overstory canopy (OSC)

Inner Zone:

Modified commercial thinning or single tree selection
Increase QMD
No Sanitation Salvage
70% OSC
Retain 7 largest trees/ac.

CALIFORNIA FOREST PRACTICE RULES

(2) Class II WLPZ Widths and Operational Requirements: All Class II WLPZs shall be composed of two zones regardless of the Watercourse type: a Core Zone and an Inner Zone. The Core Zone is nearest to the water; the Inner Zone is contiguous to the Core Zone and is furthest from the water. The width of the Core and Inner Zones vary depending on the following three factors: (i) side slope steepness in the WLPZ, (ii) whether the Watercourse is a Class II-S or Class II-L Watercourse type, and (iii) whether the Watercourse is within a watershed in the coastal anadromy zone or outside the coastal anadromy zone. Graphic depictions of zones and the abbreviated descriptions of the silvicultural prescriptions and operational requirements are shown in Figure 8.

(A) Core Zone: The width of the Core Zone varies from 10 feet to 30 feet measured from the Watercourse or Lake Transition Line. When established, no Timber Operations are permitted in this zone except for those listed in 14 CCR § 916.9 [936.9, 956.9], subsection (e)(1)(A)-(F), or practices approved pursuant to 14 CCR § 916.9 [936.9, 956.9], subsection (v). Sanitation-Salvage is prohibited except as provided in 14 CCR § 916.9 [936.9, 956.9], subsections (s), (t), and (u). Table 4 summarizes the minimum width for the Core Zone.

(B) Inner Zone: The widths of the Inner Zone vary from 35 feet to 90 feet and shall be measured from the landward edge of Core Zone or WTL, whichever is greater. Timber Operations are permitted in this zone when conducted to meet the goals of this section, including those for the Inner Zone in 14 CCR § 916.9 [936.9, 956.9], subsections (c)(2) and (4), pursuant to 14 CCR § 916.9 [936.9, 956.9], subsections (e)(1)(A)-(F) or pursuant to 14 CCR § 916.9 [936.9, 956.9] subsection (v). Harvesting prescriptions should focus on practices that use thinning from below. Inner Zone widths are summarized in Table 4.

1. Class II-S Watercourses: Any Class II-S Watercourses shall receive protection in conformance with 14 CCR §§ 916 [936, 956] through 916.7 [936.7, 956.7] in addition to the requirements listed under 14 CCR §§ 916.9 [936.9, 956.9] (g)(2)(A) and (B).

2. Class II-L Watercourses in the coastal anadromy zone: Silvicultural systems for harvesting are limited to the use of commercial thinning or single tree selection modified to meet the following requirements:

(i) When commercial thinning is used, the QMD of conifer trees greater than 8 inches dbh in the preharvest project area shall be increased in the postharvest stand.

(ii) Sanitation-Salvage is prohibited except as provided in 14 CCR § 916.9 [936.9, 956.9], subsections (s), (t) and (u).

(iii) Postharvest stand shall have a minimum 80% overstory canopy cover in the Coast and Southern Forest Districts of the coastal anadromy zone and a minimum 70% overstory canopy cover in the Northern Forest District of the coastal anadromy zone. The postharvest canopy may be composed of both conifers and hardwood species and shall have at least 25% overstory conifer canopy.

(iv) Postharvest stand shall retain the 13 largest conifer trees (live or dead) on each acre of the area that encompasses the Core and Inner Zones.

(v) Large trees retained to meet 14 CCR § 916.9 [936.9, 956.9], subsections (g)(2)(B)(2)(i) and (iii) above that are the most conducive to recruitment to provide for the beneficial functions of Riparian zones (e.g., trees that lean towards the channel, have an unimpeded fall path toward the Watercourse, are in an advanced state of decay, are located on unstable areas or downslope of such unstable areas, or have undermined roots) are to be given priority to be retained as future recruitment trees.

CALIFORNIA FOREST PRACTICE RULES

3. Class II-L Watercourses outside watersheds in the coastal anadromy zone:

Silvicultural systems for harvesting are limited to the use of commercial thinning or single tree selection modified to meet the following requirements:

- (i) When commercial thinning is used, the QMD of conifer trees greater than 8 inches dbh in the preharvest project area shall be increased in the postharvest stand.
- (ii) Sanitation-Salvage is prohibited except as provided in 14 CCR § 916.9 [936.9, 956.9], subsections (s), (t), and (u).
- (iii) Postharvest stand shall have a minimum 70% overstory canopy cover. The postharvest canopy may be composed of both conifers and hardwood species and shall have at least 25% overstory conifer canopy.
- (iv) Postharvest stand shall retain the 7 largest conifer trees (live or dead) on each acre of the area that encompasses the Core and Inner Zones.
- (v) Large trees retained to meet 14 CCR § 916.9 [936.9, 956.9], subsections (g)(2)(B)(3.)(i) and (iii) above that are the most conducive to recruitment to provide for the beneficial functions of Riparian zones (e.g., trees that lean towards the channel, have an unimpeded fall path toward the Watercourse, are in an advanced state of decay, are located on unstable areas or downslope of such unstable areas, or have undermined roots) are to be given priority to be retained as future recruitment trees.

Table 4. Core and Inner Zone widths.

Water Class	Class II-S (feet)				Class II-L (feet)			
	Watersheds in the coastal anadromy zone		Watersheds outside the coastal anadromy zone		Watersheds in the coastal anadromy zone		Watersheds outside the coastal anadromy zone	
Slope class	Core Zone (feet)	Inner Zone (feet)	Core Zone (feet)	Inner Zone (feet)	Core Zone (feet)	Inner Zone (feet)	Core Zone (feet)	Inner Zone (feet)
≤30%	15	35	10	40	30	70	20	80
30-50%	15	60	10	65	30	70	20	80
>50%	15	85	10	90	30	70	20	80

(3) Class II Watercourses in the Southern Subdistrict of the Coast Forest District: In addition to all other Forest Practice Rules applicable to timber harvesting within the Southern Subdistrict of the Coast Forest District, the following Rules apply within a Class II WLPZ. These requirements supersede any other requirements for Class II Watercourses contained in 14 CCR § 916.9(g).

(A) Retain all trees within the Class II WLPZ that meet the following criteria:

- 1. all trees located within the Channel Zone;
- 2. all trees that have boles that overlap the edge of the Channel Zone; and
- 3. all trees with live roots permeating the bank or providing channel grade control,

with the following exception:

(i) 1/3 of the stems of redwoods with live roots permeating the bank or providing channel grade control may be harvested.

(B) Where sufficient spacing exists prior to harvesting, retained redwood trees greater than or equal to 12 inches dbh shall not be spaced more than 25 feet apart.

(C) A minimum of 80% overstory canopy shall be maintained within the Channel Zone. If 80% overstory canopy is not present within the Channel Zone, the existing overstory canopy within the channel shall not be reduced.

CALIFORNIA FOREST PRACTICE RULES

Figure 7: Graphic of profile view of WLPZs for Class II Watercourses (excluding the Southern Subdistrict) (not to scale)

Class II Standard – Slopes <10%

Inner Zone: FPRs in 14 CCR 916 -916.7

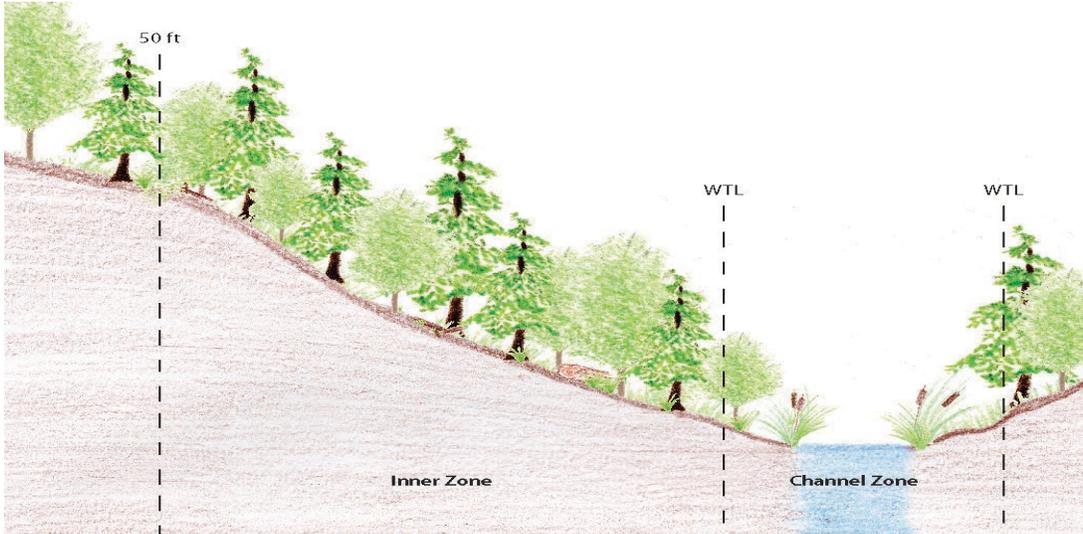

Class II Standard - Watersheds in the coastal anadromy zone

Inner Zone: FPRs in 14 CCR 916 -916.7

- 50 ft. for slopes <30%
- 75 ft for slopes 30% to 50%
- 100 ft for slopes >50%

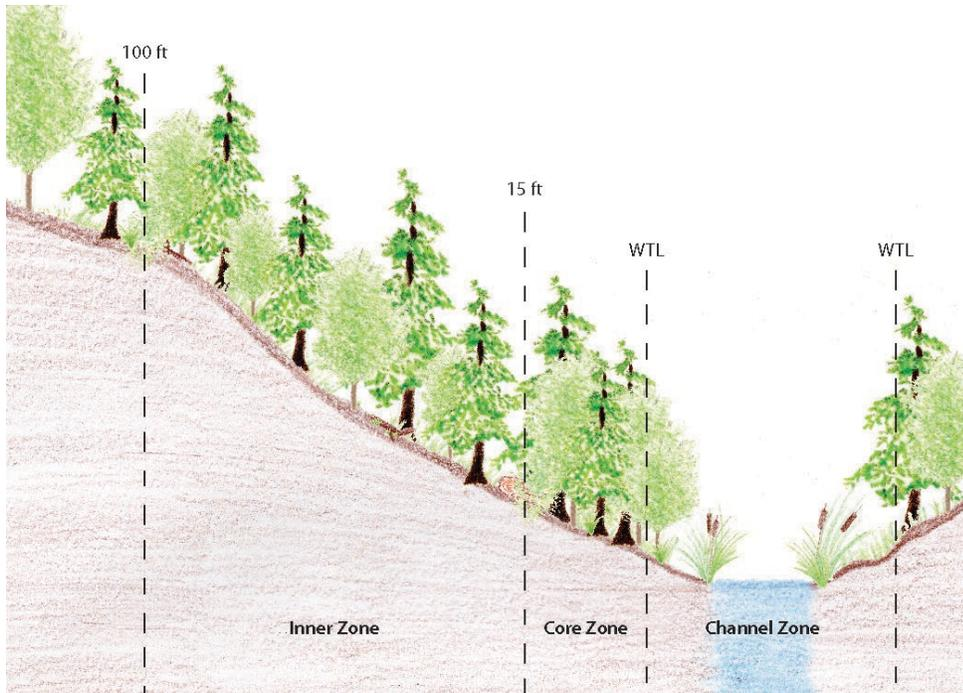

CALIFORNIA FOREST PRACTICE RULES

Class II Large - Watersheds in the coastal anadromy zone

Inner Zone:

Modified commercial thinning or single tree selection

Increase QMD

No Sanitation Salvage

Retain 80% OSC in the Coast and Southern Forest Districts of the coastal anadromy zone and 70% OSC in the Northern Forest District of the coastal anadromy zone

Retain 13 largest trees/ac.

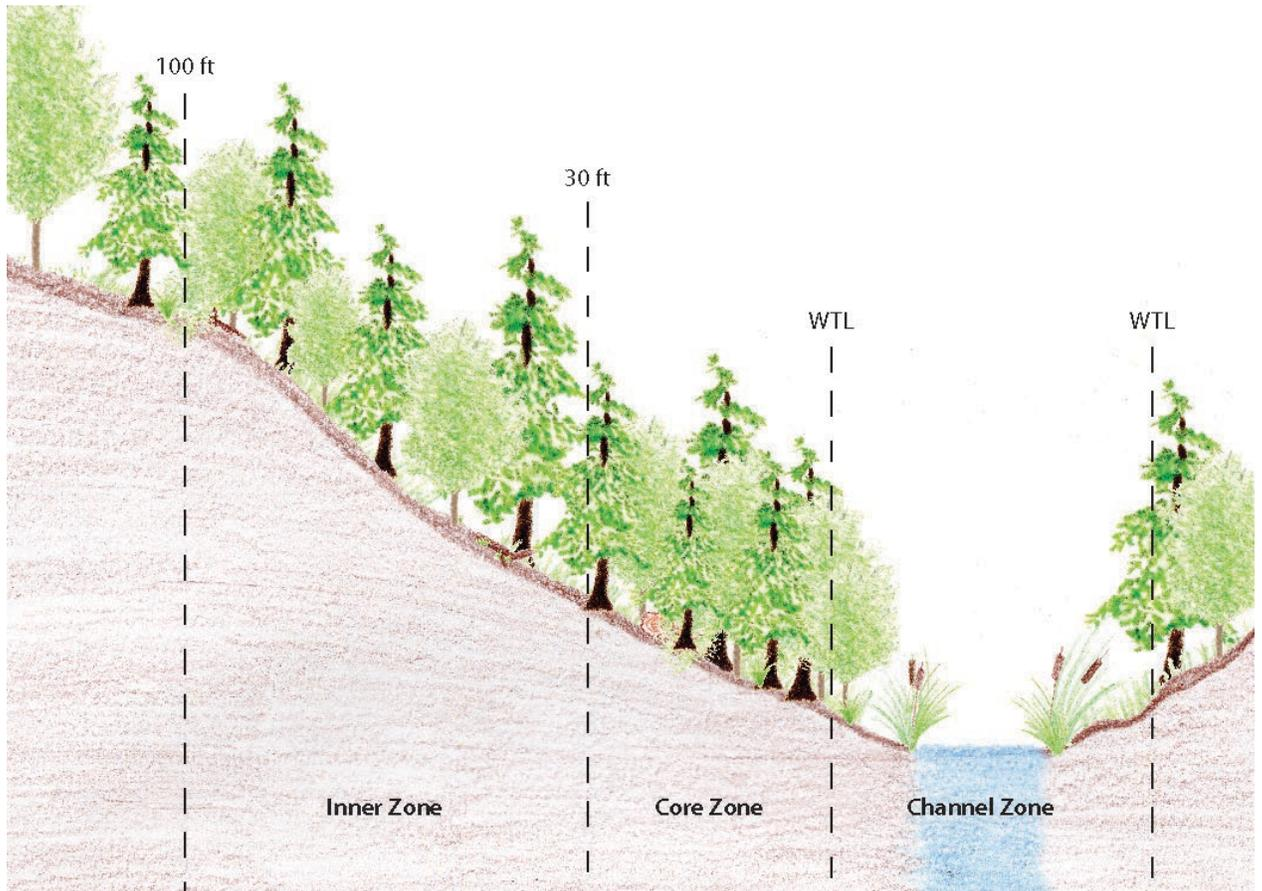

CALIFORNIA FOREST PRACTICE RULES

(D) No more than 1/3 of the conifers 18" dbh or larger may be harvested.

(h) Class III Watercourses –

The following are the minimum requirements for Timber Operations in Class III Watercourses, unless explained and justified in the plan and approved by the Director.

(1) Establish a 30 foot wide ELZ on both sides of the Watercourse for slopes less than 30% and an additional 20 foot ELZ where sideslopes are >30%. The ELZ is measured from the WTL. Within the ELZ:

(A) no new construction of tractor roads permitted;

(B) no ground based equipment on slopes >50%; and

(C) ground-based operations are limited to existing stable tractor roads that show no visible evidence of sediment deposition being transported into the adjacent Watercourse or to the use of feller-bunchers or shovel Yarding.

(2) Retain all pre-existing large wood on the ground within the ELZ that is stabilizing sediment and is necessary to prevent potential discharge into the Watercourse.

(3) Retain all pre-existing down wood and debris in the Channel Zone.

(4) Retain hardwoods, where feasible, within the ELZ.

(5) Retain all snags (except as required for safety) within the ELZ.

(6) Retain all countable trees needed to achieve resource conservation standards in 14 CCR § 912.7 [932.7, 952.7] within the ELZ.

(7) Retain all trees in the ELZ and Channel Zone which show visible indicators of providing bank or bed stability, excluding sprouting conifers that do not have boles overlapping the Channel Zone. Visible indicators of stability include roots that permeate the bank or provide channel grade control.

(8) Exceptions pursuant to 14 CCR § 916.9 [936.9, 956.9], subsections (e)(1)(A)-(F) are permitted in any ELZ and Channel Zone.

(i) Section reserved for future use.

(j) **Inner Gorge** - Where an inner gorge extends beyond a Class I WLPZ and slopes are greater than 55%, a special management zone shall be established where the use of evenaged regeneration methods is prohibited. This zone shall extend upslope to the first major break-in-slope to less than 55% for a distance of 100 feet or more, or 300 feet as measured from the Watercourse or Lake Transition Line, whichever is less. All operations on slopes exceeding 65% within an inner gorge of a Class I or II Watercourse shall be reviewed by a Professional Geologist prior to plan approval, regardless of whether they are proposed within a WLPZ or outside of a WLPZ.

(k) Year-round tractor road use limitations –

(1) Tractor roads shall not be used when operations may result in significant sediment discharge.

(l) **Extended Wet Weather Period** - No Timber Operations shall take place unless the approved plan incorporates a complete winter period operating plan pursuant to 14 CCR § 914.7 [934.7, 954.7] subsection (b).

(1) Unless the winter period operating plan proposes operations during an extended wet weather period with low antecedent soil wetness, no tractor roads shall be constructed, Reconstructed, or used on slopes that are over 40 percent and within 200 feet of a Class I, II, or III Watercourse, as measured from the Watercourse or Lake Transition Line.

(m) **Tractor Road Drainage Facility Installation** - All tractor roads shall have drainage and/or drainage collection and storage facilities installed as soon as practical following Yarding and prior to either (1) the start of any rain which causes overland flow across or along the disturbed surface within a WLPZ or within any ELZ or EEZ designated for Watercourse or lake protection, or (2) any day with a National Weather Service forecast of a chance of rain of 30 percent or more, a flash flood warning, or a flash flood watch.

(n) **Treatments to stabilize soils** - Within the WLPZ, and within any ELZ or EEZ designated for Watercourse or lake protection, treatments to stabilize soils, minimize soil erosion, and prevent significant sediment discharge shall be described in the plan as follows.

(1) Soil stabilization is required for the following areas:

(A) Areas exceeding 100 contiguous square feet where Timber Operations have exposed bare soil.

(B) Approaches to tractor road Watercourse crossings between the drainage facilities closest to the crossing.

CALIFORNIA FOREST PRACTICE RULES

(C) Any other area of disturbed soil that threatens to discharge sediment into waters in amounts that would result in a significant sediment discharge.

(2) Soil stabilization treatment measures may include, but need not be limited to, removal, armoring with rip-rap, replanting, mulching, seeding, installing commercial erosion control devices to manufacturer's specifications, or chemical soil stabilizers.

(3) Where straw or Slash mulch is used, the minimum straw coverage shall be 90 percent, and any treated area that has been reused or has less than 90 percent surface cover shall be treated again by the end of Timber Operations.

(4) Where Slash mulch is packed into the ground surface through the use of a tractor or equivalent piece of heavy equipment the minimum Slash coverage shall be 75 percent.

(5) For areas disturbed from May 1 to October 15, treatment shall be completed prior to the start of any rain that causes overland flow across or along the disturbed surface that could deliver sediment into a Watercourse or lake in quantities deleterious to the beneficial uses of water.

(6) For areas disturbed from October 15 to May 1, treatment shall be completed prior to any day for which a chance of rain of 30 percent or greater is forecast by the National Weather Service or within 10 days, whichever is earlier.

(7) Where the natural ability of ground cover is inadequate to protect beneficial uses of water by minimizing soil erosion or by filtering sediment, the plan shall specify protection measures to retain and improve the natural ability of the ground cover to filter sediment and minimize soil erosion.

(o) [Section reserved for future use.]

(p) [Section reserved for future use.]

(q) **Site Preparation** - Site Preparation activities shall be designed to prevent soil disturbance within, and minimize soil movement into, the channels of Watercourses. Prior to any Broadcast Burning for Site Preparation, burning prescriptions shall be designed to prevent loss of large woody debris in Watercourses, and vegetation and duff within a WLPZ, or within any ELZ or EEZ designated for Watercourse or lake protection. No ignition is to occur within any WLPZ, or within any ELZ or EEZ designated for Watercourse or lake protection. When burning prescriptions are proposed, the measures or burning restrictions which are intended to accomplish this goal shall be stated in the plan and included in any required burning permit. This information shall be provided in addition to the information required under 14 CCR § 915.4 [935.4, 955.4].

(r) [Section reserved for future use.]

(s) **Exemption notices** - No Timber Operations are allowed in a WLPZ, or within any ELZ or EEZ designated for Watercourse or lake protection, under exemption notices except for:

(1) Hauling on existing roads.

(2) Road maintenance.

(3) Operations conducted for public safety.

(4) Construction or reconstruction of approved Watercourse crossings.

(5) Temporary crossings of dry Class III Watercourses that do not require notification under Fish and Game Code §1600 et seq.

(6) Harvesting recommended in writing by CDFW to address specifically identified forest conditions.

(t) **Emergency notices** - No Timber Operations are allowed in a WLPZ, or within any ELZ or EEZ designated for Watercourse or lake protection, under emergency notices except for:

(1) Hauling on existing roads.

(2) Road maintenance.

(3) Operations conducted for public safety.

(4) Construction or reconstruction of approved Watercourse crossings.

(5) Temporary crossings of dry Class III Watercourses that do not require notification under Fish and Game Code §1600 et seq.

(6) Harvesting recommended in writing by CDFW to address specifically identified forest conditions.

(7) The harvest of dead or dying conifer trees subject to the following conditions:

(A) Retention of all trees in the core zone of Class I and Class II-L Watercourses.

(B) Within any WLPZ, ELZ, or EEZ designated for Class II or III Watercourse protection, a

CALIFORNIA FOREST PRACTICE RULES

minimum of two dead, dying, or diseased conifer trees per acre at least sixteen (16) inches d.b.h. and fifty (50) feet tall shall be retained within fifty (50) feet of the Watercourse transition line.

(C) Trees to be harvested or retained shall be marked by, or under the supervision of, an RPF prior to Timber Operations within the WLPZ or ELZ/EEZ.

(D) Within the WLPZ or ELZ/EEZ, if the stocking standards of 14 CCR § 912 [932, 952].7 are not met upon completion of Timber Operations, unless the area meets the definition of substantially damaged Timberlands, at least ten (10) trees shall be planted for each tree harvested but need not exceed the point count standards contained in 14 CCR § 912.7(b)(1) [932.7(b)(1), 952.7(b)(1)], as appropriate.

(8) The harvest of trees or vegetation designated for removal pursuant to 14 CCR § 1052.5 to address Sudden Oak Death that are:

(A) symptomatic of the pathogen that causes Sudden Oak Death and confirmed infected by a certified lab; or

(B) host hardwood trees that could spread the pathogen.

(u) **Salvage logging** - No salvage logging is allowed in a WLPZ without an approved HCP, a PTEIR, an SYP, or an approved plan that contains a section that sets forth objectives, goals, and measurable results for streamside salvage operations.

(1) This section does not apply to emergency operations under 14 CCR § 1052.

(v) Site-specific measures or nonstandard operational provisions

(1) In consideration of the spatial variability of the forest landscape, the RPF may propose site-specific measures or nonstandard operational provisions in place of any of the provisions contained in this section. Site specific plans may be submitted when, in the judgment of the RPF, such measures or provisions offer a more effective or more feasible way of achieving the goals and objectives set forth in 14 CCR § 916.9 [936.9, 956.9], subsections (a) and (c), and would result in effects to the beneficial functions of the Riparian zone equal to or more favorable than those expected to result from the application of the operational provisions required under 14 CCR § 916.9 [936.9, 956.9].

(2) Measures or provisions proposed pursuant to 14 CCR § 916.9 [936.9, 956.9], subsections (v) shall only be approved when the plan incorporates an evaluation of the beneficial functions of the Riparian zone as set forth in subsection (3) below. In the event of measures limited in applicability to specific sites, the submitter may instead of an evaluation, obtain written concurrence from CDFW prior to plan submittal. RPFs may request a preconsultation for the site specific plan and the Director may agree and request staff from responsible agencies.

(3) The evaluation of the beneficial functions of the Riparian zone shall be included in addition to any evaluation required by all other District Forest Practice Rules, may incorporate by reference any such evaluation, and shall include the following components scaled appropriately to the scope of the proposed measure(s) or provision(s) and the beneficial functions potentially affected.

(A) The following are required components of an evaluation conducted pursuant to 14 CCR § 916.9 [936.9, 956.9], subsection (v)(3):

1. A description of the evaluation area. If the evaluation area is different than the watershed assessment area described pursuant to Technical Rule Addendum No. 2, the RPF shall briefly explain the rationale for establishing the evaluation area.

2. A description of the current condition of the Riparian zone within the evaluation area related to the beneficial functions. The RPF may incorporate by reference any conditions described in the plan pursuant to 14 CCR § 916.4 [936.4, 956.4], subsection (a). The RPF shall use the best available information, at the appropriate scale, to describe the existing vegetation, timber stand characteristics, roads, skid trails, Landings, channel types, unstable areas, flood prone areas, and overflow channels.

3. An identification of the beneficial functions that may potentially be affected by the proposed measure(s) or provision(s).

4. An identification of the potential effects to the beneficial functions, both positive and negative. The RPF may use a reasoned analysis to describe the effects and may assign ratings of high, moderate and low to those effects that may individually or cumulatively limit anadromous salmonid distribution and abundance in the watershed.

5. A detailed description of the site-specific measure(s) or nonstandard operational provision(s) proposed. The description should address at a minimum the relationships between the Riparian

CALIFORNIA FOREST PRACTICE RULES

stand characteristics and ecological functions, the relative importance of the beneficial functions of the Riparian zone to the Watercourse, the cost effectiveness of the measure(s) or provision(s), and the predicted consequences.

6. A schedule for implementing proposed management practices.

7. A plan for monitoring consistent with 14 CCR § 916.11 [936.11, 956.11].

(4) Measures or provisions proposed pursuant to 14 CCR § 916.9 [936.9, 956.9], subsections (v) shall only be approved when they meet the following additional standards:

(A) They must be based upon the best available science, and explained and justified in the plan.

(B) They must identify potential significant adverse Impacts that may occur to listed salmonids or the beneficial functions of the Riparian zone as a result of the proposed measure(s) or provision(s).

(C) They must identify feasible systems, methods, procedures or approaches proposed to avoid or mitigate identified potential significant adverse Impacts to a level of insignificance.

(D) They must be written so they provide clear instructions and enforceable standards for the Timber Operator;

(E) They must provide that, where appropriate for implementation of the measure(s) or provision(s), the plan submitter is responsible for retaining an RPF to aid in interpreting the plan to the Timber Operator and Timberland Owner on a continuing basis to help assure compliance with the measure(s) or provision(s).

(F) They must identify each standard prescription that would be replaced by the measure(s) or provision(s) proposed.

(5) Guidance is provided below for site specific plans for flood prone areas:

(A) Site-Specific Plans for Watercourses with flood prone areas or Channel Migration

Zones:

This section is an optional approach to be used at the discretion of the plan submitter. When used, this section replaces requirements found in 14 CCR § 916.9 [936.9, 956.9], subsection (f)(3). The goal of this approach is to allow RPFs to develop a site specific plan for salmonid habitat protection on a flood prone area. Site specific plans are to lead to development of properly functioning salmonid habitat and can include active management to restore the beneficial uses of the Riparian zone.

(B) Timber Operations are limited to the flood prone areas beyond the outer margin of a CMZ.

(C) RPFs are to propose Riparian protection zones and management practices that are designed for local conditions.

(D) Site specific assessments shall include:

1. Identifying the issues that need to be considered for Watercourse and Riparian protections [refer to Table 1 of “Flood Prone Area Considerations in the Coast Redwood Zone “(Riparian Protection Committee Report, Cafferata et al 2005)].

2. Describing processes that need to be considered for the issues identified above.

3. Developing a method to define a desired trajectory for Watercourse and Riparian conditions in the context of the goals of 14 CCR § 916.9 [936.9, 956.9], subsection (a).

4. Defining how the proposed operations will aid reaching the desired trajectories.

5. Disclosing assumptions being made at each step and limits to both the science and the proposed management activities.

6. Identifying how to determine what needs to be monitored and how to conduct the monitoring.

7. Supporting documentation is required including but not limited to field data, NetMap analysis, large wood modeling results, etc.

(E) As described in the “Flood Prone Area Considerations in the Coast Redwood Zone” (Cafferata et al 2005), the site-specific plan for Class I flood prone area management shall include:

1. an inventory of the flood prone area for all hydrologic, geomorphic, and biological functions present that can be affected by Timber Operations;

2. a determination of the category of inundation where management is proposed

CALIFORNIA FOREST PRACTICE RULES

[i.e., very frequent (1-5 yr. recurrence interval or RI), frequent (5-20 yr. RI), moderately frequent (20-50 yr. RI), or infrequent (50+ yr. RI)]; and

3. an appropriate analysis for functions present in light of possible significant adverse Impacts from management. Analysis for hydrologic functions may include how the flood prone area vegetative roughness will change with Timber Operations. Analyses for geomorphic functions may include how proposed operations will change bank stabilization, amount of soil disturbance on the flood prone area, and the potential for channel avulsion. Analyses for biological functions may include how harvesting will affect overflow channels, large wood recruitment, Stream shading, Riparian microclimate, organic matter input, and terrestrial wildlife habitat.

(F) Disclosure and analysis requirements increase with increased risk associated with the proposed level of activity and the increased frequency of inundation in the flood prone area. In particular, management proposed within the 20 year recurrence interval flood prone area in a watershed with coho salmon habitat or restorable habitat requires detailed analysis.

(G) In addition to considering how proposed prescriptions will affect flood prone area functions at the project level, site specific plans must consider a larger watershed perspective that includes consideration of the Stream network and past activities in the watershed. Also, consideration must be given to the current condition of the flood prone area.

(H) Information provided in the “Flood Prone Area Considerations in the Coast Redwood Zone “ (Cafferata et al 2005) is to be used for guidance in the coast redwood zone.

(I) The site-specific plan for Class I Riparian management must: (1) have Review Team agencies pre-consultation and receive concurrence from the Review Team agencies, including CDFW, and (2) include a monitoring component.

(6) Guidance is provided below for site specific plans for fire hazard reduction:

(A) For site specific plans that address WLPZs having conditions where catastrophic, stand replacing wildfire will result in significant adverse effects to salmonid species, Riparian habitat or other wildlife species, the site specific plan shall address measure(s) or provision(s) that create fire resilient forests, promote reduced fire intensities, and retain functional habitat following a wildfire. Site specific plans proposed for fuel hazard reduction shall contain information demonstrating the potential for severe fire behavior and likelihood of stand replacing fires. Fuel reduction measure(s) or provision(s) shall be designed to reduce fire behavior to levels appropriate for the region and Riparian area. Measure(s) or provision(s) include, but are not limited to, activities that eliminate the vertical and horizontal continuity among all vegetative fuel layers (surface fuels, ladder fuels and crown fuels), focus on reducing surface and ladder fuel hazards, and simultaneously meet goals and objectives of 14 CCR § 916.9 [936.9, 956.9] subsections (a) and (c).

(7) No site-specific measure(s) or nonstandard operational provision(s) proposed pursuant to 14 CCR § 916.9 [936.9, 956.9], subsection (v) may be prescribed by an RPF or approved by the Director in lieu of the following Rules:

(A) The Rules contained in Subchapter 2 (Application of Forest Practice Rules); Article 2 (Ratings and Standards) and Article 11 (Coastal Commission Special Treatment Areas) of Subchapter 4 (Coast Forest District Rules); Article 2 (Ratings and Standards) of Subchapter 5 (Northern Forest District Rules); Article 2 (Ratings and Standards) and Article 11 (Coastal Commission Special Treatment Areas) of Subchapter 6 (Southern Forest District Rules); and Subchapter 7 (Administration) of Chapter 4, Division 1.5 of Title 14 of the California Code of Regulations; or

(B) Any Forest Practice Rule pertaining to the width of the Special Treatment Area adjacent to a wild and scenic river declared pursuant to PRC 5093.50, et seq.; or

(C) Any Forest Practice Rules or parts of Rules that incorporate practices or standards specified in the FPA.

(8) The Director shall not accept for inclusion in a plan any site-specific measures or non-standard operational provisions as described in this section where the CDFW or where two or more agencies listed in PRC § 4582.6 and 14 CCR § 1037.3 have submitted written comments which lead to the Director's conclusion that the proposed measures or provisions will not meet the goal of this section and the agencies participated in the review of the plan, including an on-the-ground inspection.

(9) Site-specific measures or nonstandard operational provisions proposed pursuant to 14 CCR §

CALIFORNIA FOREST PRACTICE RULES

916.9 [936.9, 956.9], subsection (v) shall not be considered alternative practices pursuant to 14 CCR §§ 897 or 914.9 [934.9, 954.9], in lieu practices or site specific practices pursuant to 14 CCR § 916.1 [936.1, 956.1], or alternative prescriptions for the protection of Watercourses or lakes pursuant to 14 CCR § 916. 6 [936.6, 956.6].

(10) Board staff and the Department shall work with agencies, stakeholders, and appropriate scientific participants (e.g., Monitoring Study Group, Technical Advisory Committee) in a transparent process to: (1) describe and implement two pilot Projects, including monitored results, using site-specific or non-standard operational provisions; and (2) provide recommendations to the Board for consideration for adoption to provide detailed guidance for the application of site-specific or non-standard operational provisions. The pilot Projects and guidance shall address cumulative and planning watershed Impacts, and the guidance may address the appropriate standards the site-specific or non-operational provisions shall meet. A report on the progress of the pilot Projects and implementation guidance shall be presented to the Board within 18 months of the effective date of this regulation.

(w) Except when expressly required by 14 CCR § 916.9 [936.9, 956.9], subsections (w)(1)-(5) below, the provisions of 14 CCR § 916.9 [936.9, 956.9] shall not apply to a plan that is subject to:

(1) a valid incidental take permit issued by CDFW pursuant to Section 2081(b) of the F&GC that addresses anadromous salmonid protection; or

(2) a federal incidental take statement or incidental take permit that addresses anadromous salmonid protection, for which a consistency determination has been made pursuant to Section 2080.1 of the F&GC; or

(3) a valid natural community conservation plan that addresses anadromous salmonid protection approved by CDFW under section 2835 of the F&GC; or

(4) a valid Habitat Conservation Plan that addresses anadromous salmonid protection, approved under Section 10 of the federal Endangered Species Act of 1973; or

(5) project revisions, guidelines, or take avoidance measures pursuant to a memorandum of understanding or a planning agreement entered into between the plan submitter and CDFW in preparation of obtaining a natural community conservation plan that addresses anadromous salmonid protection.

916.10, 936.10, 956.10 Domestic Water Supply Protection [All Districts]

(a) When proposed Timber Operations may threaten to degrade a domestic water supply the Director shall evaluate any mitigations recommended prior to the close of the public comment period (PRC 4582.7) and shall require the adoption of those practices which are feasible and necessary to protect the quality and beneficial use of the supply.

(b) The Director may require a post-harvest evaluation of the effectiveness of the mitigations and practices designed to protect the domestic water supply as a condition of plan approval. The Director shall require an evaluation at the request of the California Regional Water Quality Control Board, or any affected water purveyor, if the necessity for the evaluation is supported by substantial evidence in the record. This evidence may include, but is not limited to, potential land failures, accelerated rate of road construction or harvesting within a watershed, concentration or intensity of harvesting activity near Streams or springs. The design and implementation of the evaluation shall be done in consultation with the Director, appropriate RWQCB, and THP submitter, and the sufficiency of the information requested by the Director shall be judged in light of reasonableness and practicality.

916.11, 936.11, 956.11 Effectiveness and Implementation Monitoring [All Districts]

(a) Where Timber Operations will be conducted within a WLPZ, the Director may require a post-harvest evaluation of the effectiveness of the mitigations and practices designed to protect the Watercourse(s) or lake(s) as a condition of plan approval. The Director shall require such an evaluation if the necessity for the evaluation is supported by substantial evidence in the record. This evidence may include, but is not limited to, potential land failures, accelerated rate of road construction or harvesting within a watershed, concentration or intensity of harvesting activity near Watercourses, and potential for accelerated windthrow. The design and implementation of the evaluation shall be done in consultation with the Director, the RWQCB or CDFW, and THP submitter, and the sufficiency of the information requested by the Director shall be judged in light of reasonableness and practicality. The evaluation may utilize procedures including, but not limited, to:

CALIFORNIA FOREST PRACTICE RULES

- (1) Procedures for effectiveness and implementation monitoring,
- (2) Existing landowner monitoring programs, or
- (3) Photographic monitoring

916.11.1 and 936.11.1 Monitoring for Adaptive Management in Watersheds with Coho Salmon

(a) Goal: The Board will develop a monitoring and adaptive management program for timber harvesting operations in watersheds with coho salmon. The purpose of the program will be: (i) to determine whether or not the operational Forest Practice Rules and associated hillslope and instream mitigation measures afford a level of protection that is both appropriate and adequate to ensure protection of coho salmon and its habitat, (ii) to provide monitoring necessary to ensure the Forest Practice Rules are being implemented in a manner consistent with the California Endangered Species Act as required under 14 CCR § 896, and (iii) to provide a timely feedback process for the Board to assess rule effectiveness in meeting the stated goals under subsections (i) and (ii).

(1) The monitoring component of the program will provide the information necessary to evaluate the effectiveness of mitigation measures and identify when site-specific mitigation or operational Rules should be revised to better accomplish the goals of the Board.

(A) Four types of monitoring will be addressed under the program including: (i) compliance, (ii) implementation, (iii) effectiveness, and (iv) validation.

(B) Review Team agencies will continue to conduct mandated compliance and implementation monitoring as part of their regulatory responsibilities.

(C) Effectiveness monitoring will be undertaken by the landowner; or be a cooperative effort between landowners and the Department, Review Team agencies, or a cooperative interdisciplinary team.

(D) Long-term validation monitoring will be undertaken by the Department, or facilitated through cooperative agreements among stakeholders and Review Team agencies.

(E) The Board or its designee may include any monitoring that meets the intent of this section, including any efforts that are already underway by the landowner, agencies or other cooperators.

(2) The adaptive management component of the program will be a process of action-based planning, monitoring, evaluating and adjusting through use of the scientific method; with the objective of maintaining fully functioning habitat conditions and facilitating conservation of coho salmon populations.

(A) Four elements of adaptive management will be addressed under the program including: (i) identification of substantial new information, (ii) collection of substantial new information, (iii) evaluation of substantial new information, and (iv) determination regarding the necessity or benefit of adjustments and improvements to mitigation and protective measures, including the Forest Practice Rules, based upon the substantial new information.

(b) (1) In collaboration with the Department and other Review Team agencies, the Board shall appoint a scientific technical advisory committee to develop monitoring practices to evaluate the effectiveness of mitigation measures at the appropriate scale.

(A) In development of monitoring practices, the Board's appointed scientific technical advisory committee may also engage other experts in the field for assistance.

(B) The monitoring practices will be applied by the landowner; or be a cooperative effort between landowners and the Department, Review Team agencies, or a cooperative interdisciplinary team.

(2) Monitoring practices and strategies may be peer reviewed by a scientific technical advisory committee as directed by the Board.

(3) The design and implementation of monitoring shall be done in consultation with the Department and other Review Team agencies, and the sufficiency of information shall be judged in light of its scientific merit and what is reasonable and practical.

(A) Monitoring data shall be derived from agency monitoring programs, landowner monitoring programs, or cooperative Projects.

(4) As a condition of plan approval, based upon substantial evidence in the record, the Director may require monitoring:

(A) Any time after plan approval,

CALIFORNIA FOREST PRACTICE RULES

- (B) Concurrent with Timber Operations, and
- (C) After completion of operations during the remainder of the prescribed maintenance period.
- (5) Monitoring data collected pursuant to (b)(4) or (b)(6) shall be provided to the Board annually.
- (6) The plan shall incorporate monitoring requirements in conformance with the requirements of a valid incidental take permit for coho salmon within the planning watershed that has been authorized pursuant to the following:

(A) a valid incidental take permit issued by DFG pursuant to Section 2081(b) of the Fish and Game Code; or

(B) a federal incidental take statement or incidental take permit, for which a consistency determination has been made pursuant to Section 2080.1 of the Fish and Game Code; or

(C) Section 2835 of the Fish and Game Code under a valid natural community conservation plan approved by DFG.

(c) The Department shall prepare an annual report in conjunction with a Board appointed technical subcommittee summarizing progress and significant findings from monitoring activities collected throughout the year in accordance with subsection (b)(4) above. The report shall be (i) provided to the Board during the first quarter of each calendar year, (ii) made available to the public upon request, and (iii) placed on the Board's website for at least 180 days.

(d) Based upon the findings presented in the annual monitoring report(s), the Director, in conjunction with the Board appointed technical subcommittee, may recommend additions, deletions or modifications to the Forest Practice Rules if the necessity for such a change is supported by substantial evidence in the reports. A specific recommendation based upon the findings that a rule requirement is no longer necessary shall also be supported by substantial evidence.

916.12, 936.12, 956.12 Section 303(d) Listed Watersheds [All Districts]

For any planning watershed in which Timber Operations could contribute to the pollutants or stressors which have been identified as limiting water quality in a water body listed pursuant to 303(d) Federal Clean Water Act, the following shall apply:

(a) The Department shall, in collaboration with the appropriate RWQCB and SWRCB, prioritize watersheds in which the following will be done: 1) conduct or participate in any further assessment or analysis of the watershed that may be needed, 2) participate in the development of Total Maximum Daily Load (TMDL) problem assessment, source assessment, or load allocations related to Timber Operations, and 3) if existing Rules are deemed not to be sufficient, develop recommendations for watershed-specific silvicultural implementation, enforcement and monitoring practices to be applied by the Department.

(b) The Department shall prepare a report setting forth the Department's findings and recommendations from the activities identified pursuant to (a) above. The report shall be submitted to the Board and the appropriate RWQCB. The report shall be made available to the public upon request and placed on the Boards' website for a 90-day period.

(c) Where the Department has recommended that the adoption of watershed specific Rules is needed, the Board shall consider that recommendation as a proposal for rulemaking under the Administrative Procedures Act (Section 11340 et. seq. Gov. Code) and shall begin that process within 180 days following receipt of that report.

(d) These watershed specific Rules shall be developed in collaboration with the appropriate RWQCB, the landowner(s) or designee with land in the planning watershed, and other persons or groups within the watershed, and may also be incorporated into a TMDL implementation plan.

(e) The watershed specific Rules shall remain in effect until the water body has been removed from the 303(d) list, or that the Board finds, after consulting with the appropriate RWQCB, that Timber Operations are no longer a significant source of the pollutant or stressor that limits water quality in the listed water body.

Article 7 Hazard Reduction

917, 937 Hazard Reduction [Coast, Northern]

This article shall provide standards for the treatment of snags and logging Slash in order to reduce fire and pest safety hazards in the logging area, to protect such area from potential insect and disease attack, and to

CALIFORNIA FOREST PRACTICE RULES

prepare the area for natural or artificial reforestation while retaining wildlife habitat.

957 Hazard Reduction [Southern]

This article shall provide standards for the treatment of snags and logging Slash in order to reduce the fire and pest safety hazards in the logging area, to protect such area from potential insect and disease attack, and to prepare the area for natural or artificial reforestation while retaining wildlife habitat.

917.2 Treatment of Slash to Reduce Fire Hazard [Coast]

The following standards shall apply to the treatment of slash created by Timber Operations within the Plan area and on road adjacent to the Plan area.

(a) Slash to be treated by piling and burning shall be treated as follows:

(1) Piles created prior to September 1 shall be treated not later than April 1 of the year following its creation, or within 30 days following climatic access after April 1 of the year following its creation.

(2) Piles created on or after September 1 shall be treated not later than April 1 of the second year following its creation, or within 30 days following climatic access after April 1 of the second year following its creation.

(3) Alternatives to (1) and/or (2) shall be justified in the plan by the RPF and may be approved by the Director.

(b) Within 100 feet of the edge of the traveled surface of Public Roads, and within 50 feet of the edge of the traveled surface of permanent private roads open for public use where permission to pass is not required, Slash created and trees knocked down by Timber Operations shall be treated by Lopping for Fire Hazard Reduction, piling and burning, chipping, burying or removal from the zone.

(c) All Slash and Woody Debris greater than one inch but less than eight inches in diameter within 100 feet of Approved and Legally Permitted Habitable Structures shall be removed or piled and burned; all Slash created between 100-200 feet of Approved and Legally Permitted Habitable Structures shall be Lopped for Fire Hazard Reduction, removed, chipped or piled and burned; Lopping may be required between 200-500 feet where unusual fire risk or hazard exist as determined by the Director or the RPF.

(d) An alternative to treating Slash and Woody Debris along roads and within 200 feet of Approved and Legally Permitted Habitable Structures may be approved by the Director when the RPF explains and justifies in the Plans how equal fire protection will be provided. The alternative shall include a description of the alternate treatment(s) and the portion(s) of the Plan area in which they will be utilized. In proposing alternate slash treatments, the RPF shall consider the estimated amount and distribution of slash to be created by the operation, type of remaining vegetation, topography, climate, and degree of public exposure fire history.

937.2 Treatment of Logging Slash to Reduce Fire Hazard in the Northern Forest District [Northern]

The following standards shall apply to the treatment of slash created by Timber Operations within the Plan area and on roads adjacent to the Plan area.

(a) Slash to be treated by piling and burning shall be treated as follows:

(1) Piles created prior to September 1 shall be treated not later than April 1 of the year following its creation, or within 30 days following climatic access after April 1 of the year following its creation.

(2) Piles created on or after September 1 shall be treated not later than April 1 of the second year following its creation, or within 30 days following climatic access after April 1 of the second year following its creation.

(3) Alternatives to (1) and/or (2) shall be justified in the plan by the RPF and may be approved by the Director.

(b) Within 100 feet of the edge of the traveled surface of Public Roads, and within 50 feet of the edge of the traveled surface of permanent private roads open for public use where permission to pass is not required, Slash created and trees knocked down by Timber Operations shall be treated by Lopping for Fire Hazard Reduction, piling and burning, chipping, burying or removal from the zone.

(c) All Slash and Woody Debris greater than one inch but less than eight inches in diameter within 100 feet of Approved and Legally Permitted Habitable Structures shall be removed or piled and burned; all Slash created between 100-200 feet of Approved and Legally Permitted Habitable Structures shall be Lopped for

CALIFORNIA FOREST PRACTICE RULES

Fire Hazard Reduction, removed, chipped or piled and burned; Lopping may be required between 200-500 feet where unusual fire risk or hazard exist as determined by the Director or the RPF.

(d) An alternative to treating Slash and Woody Debris along roads and within 200 feet of Approved and Legally Permitted Habitable Structures may be approved by the Director when the RPF explains and justifies in the Plans how equal fire protection will be provided. The alternative shall include a description of the alternate treatment(s) and the portion(s) of the Plan area in which they will be utilized. In proposing alternate slash treatments, the RPF shall consider the estimated amount and distribution of slash to be created by the operation, type of remaining vegetation, topography, climate, and degree of public exposure fire history.

957.2 Treatment of Slash to Reduce Fire Hazard [Southern]

The following standards shall apply to the treatment of slash created by Timber Operations within the Plan area and on road adjacent to the Plan area.

(a) Slash to be treated by piling and burning shall be treated as follows:

(1) Piles created prior to September 1 shall be treated not later than April 1 of the year following its creation, or within 30 days following climatic access after April 1 of the year following its creation.

(2) Piles created on or after September 1 shall be treated not later than April 1 of the second year following its creation, or within 30 days following climatic access after April 1 of the second year following its creation.

(3) Alternatives to (1) and/or (2) shall be justified in the plan by the RPF and may be approved by the Director.

(b) Within 100 feet of the edge of the traveled surface of Public Roads, and within 50 feet of the edge of the traveled surface of permanent [*and seasonal*] private roads open for public use where permission to pass is not required, Slash created and trees knocked down by Timber Operations shall be treated by Lopping for Fire Hazard Reduction, piling and burning, chipping, burying or removal from the zone.

(c) All Slash and Woody Debris greater than one inch but less than eight inches in diameter within 100 feet of Approved and Legally Permitted Habitable Structures shall be removed or piled and burned; all Slash created between 100-200 feet of Approved and Legally Permitted Habitable Structures shall be Lopped for Fire Hazard Reduction, removed, chipped or piled and burned; Lopping may be required between 200-500 feet where unusual fire risk or hazard exist as determined by the Director or the RPF.

(d) An alternative to treating Slash and Woody Debris along roads and within 200 feet of Approved and Legally Permitted Habitable Structures may be approved by the Director when the RPF explains and justifies in the Plans how equal fire protection will be provided. The alternative shall include a description of the alternate treatment(s) and the portion(s) of the Plan area in which they will be utilized. In proposing alternate slash treatments, the RPF shall consider the estimated amount and distribution of slash to be created by the operation, type of remaining vegetation, topography, climate, and degree of public exposure fire history.

917.3 Prescribed Broadcast Burning of Slash [Coast]

Broadcast Burning may be prescribed for Slash treatment subject to the following condition:

(a) It may occur consistent with PRC § 4423;

(b) It may occur within cleared firebreaks of not less than ten (10) feet in width;

(c) Use of the Broadcast Burning prescription in the Watercourse and Lake Protection Zone for Class I, and II waters, is prohibited. Where necessary to protect downstream Beneficial Uses, the Director may prohibit burning prescriptions in Class III Watercourses;

(d) Exceptions to requirements (a), (b), and (c) above may be granted to any time of year provided a Project-type burning permit is obtained prior to burning and the terms of the permit are adhered to while burning.

937.3 Prescribed Broadcast Burning of Slash [Northern]

Broadcast Burning may be prescribed for Slash treatment subject to the following conditions:

(a) Such burning shall be done only after the first heavy fall rains and shall be completed before April 1;

(b) It may occur within cleared firebreaks of not less than 10 ft. (3.05 m) in width;

(c) Use of the Broadcast Burning prescription in the Watercourse and Lake Protection Zone for Class I,

CALIFORNIA FOREST PRACTICE RULES

and Class II, is prohibited. Where necessary to protect downstream beneficial uses, the Director may prohibit burning prescriptions in Class III Watercourses;

(d) Exceptions to requirements (a), (b) and (c) above may be granted provided a project-type burning permit is obtained prior to burning and the terms of the permit are adhered to while burning.

957.3 Prescribed Broadcast Burning of Slash [Southern]

Outside the High Use Subdistrict, Broadcast Burning may be prescribed for Slash treatment subject to the following conditions:

(a) Such burning shall be done only after the first heavy fall rains and shall be completed before April 1;

(b) It may occur within cleared firebreaks of not less than 10 ft. (3.05 m) in width;

(c) Use of the Broadcast Burning prescription in the Watercourse and Lake Protection Zone for Class I, and Class II, is prohibited. Where necessary to protect downstream beneficial uses, the Director may prohibit burning prescriptions in Class III Watercourses;

(d) Exceptions to requirements (a), (b) and (c) above may be granted provided a project-type burning permit is obtained prior to burning and the terms of the permit are adhered to while burning.

917.4 Treatment of Logging Slash in the Southern Subdistrict [Coast]

To reduce fire hazards within the Southern Subdistrict of the Coast Forest District, treatment of Slash shall be done in addition to requirements of 14 CCR § 917.2 as follows:

(a) To provide more efficient firebreaks the areas within fifty (50) feet of the edge of all Public Roads shall be kept free of Slash. Slash between fifty (50) feet and one hundred (100) feet of the edge of said roads and Slash between one hundred to two hundred (100-200) feet of all Approved and Legally Permitted Habitable Structures shall be treated by piling and burning, chipping, burying, removal, or Lopping to within twelve (12) inches above the ground not later than April 1 of the year following its creation. Distances shall be measured along the surface of the ground. Timber Operations shall not cause a violation of PRC § 4291.

(b) All Slash and Woody Debris created by Timber Operations greater than one (1) inch but less than eight (8) inches in Diameter within one hundred (100) feet of Approved and Legally Permitted Habitable Structures shall be removed or piled and burned.

(c) Concentrations of Slash around logging Landings or located within the Logging Area excluding those areas substantially covered with logs on the ground, shall be crushed, chipped, spread, piled and burned, or otherwise treated no later than April 1st of the following year following their creation.

(d) Slash within the Logging Area, excluding those areas substantially covered with logs on the ground, shall be lopped over the entire Logging Area by April 1st of the year following the creation of the Slash. Slash along roads in the Logging Area shall be lopped concurrently with its creation.

957.4 Treatment of Logging Slash in the High Use Subdistrict [Southern]

Slash in the High Use Subdistrict shall be treated as follows:

(a) Throughout the logging area, all limbs shall be lopped from the unutilized portions of felled trees and all other trees felled or pushed over during Timber Operations. This lopping shall be done concurrently with the Timber Operations and scattered so that no limb or stem larger than 4 in. (10.2 cm) in diameter will be covered with Slash and no Slash shall generally be more than 24 in. (61.0 cm) above the ground.

(b) Slash shall be treated by chipping, piling and burning, burying, or removal on the following areas within all distances measured along the surface to the ground.

(1) Within a distance of 200 feet (60.96 m) of structures used for habitation;

(2) Within 200 feet (60.96 m) of the edge of any road accessible to the public;

(3) Within 100 feet (30.48 m) of trails established for and used by the public;

(4) Within a distance of 200 feet (60.96 m) of areas established for and used by the public for picnicking or camping.

(c) Slash treatment must be done concurrently with logging or road construction. On areas logged between April 1st and October 1st, if the Slash is not disposed of in some other manner, it shall be piled progressively for burning. Piling shall not take place earlier than the 15th day nor later than the 45th day following cutting. Between October 1st and April 1st of the following year, the Slash to be burned shall be

CALIFORNIA FOREST PRACTICE RULES

progressively piled and burned not later than 30 days following cutting.

(d) Prescribed Broadcast Burning of Slash is allowed in the High Use Subdistrict when a permit is obtained from the Director or his representative.

917.5, 937.5, 957.5 Burning of Piles and Concentrations of Slash [All Districts with minor variances]

When the option of burning piles or concentrations of Slash is chosen to meet the Slash treatment requirements as specified in these Rules, such burning shall be done as follows:

(a) Piles and concentrations shall be sufficiently free of soil and other noncombustible material for effective burning.

(b) The piles and concentrations shall be burned at a safe time during the first wet fall or winter weather or other safe period following piling and according to laws and regulations. Piles and concentrations that fail to burn sufficiently to remove the fire hazard shall be further treated to eliminate that hazard. All necessary precautions shall be taken to confine such burning to the piled Slash.

917.6, 937.6, 957.6 Notification of Burning [All Districts]

The local representative of the Director shall be notified in advance of the time and place of any burning of logging Slash. Any burning shall be done in the manner provided by Law.

917.7, 937.7, 957.7 Protection of Residual Trees [All Districts]

Slash burning operations and fire hazard abatement operations shall be conducted in a manner which will not damage residual trees and reproduction to the extent that they will not qualify to meet the silvicultural and stocking requirements of the Rules.

917.9, 937.9, 957.9 Prevention Practices. [All Districts]

Timber Operations shall be conducted so as to minimize the build-up of destructive insect populations or the spread of forest diseases. To achieve this goal the following shall occur:

(a) Where THPs are in areas where the Board of Forestry has declared a zone of infestation or infection pursuant to PRC sections 4712 - 4718, the RPF shall identify feasible measures being taken to mitigate adverse infestation or infection Impacts from the timber operation.

(b) Where significant adverse insect or disease build-ups are identified by the RPF preparing the plan or the Director on an area to be harvested under a THP, the plan shall include feasible measures to address the problem.

(c) The Board of Forestry has determined that insects breeding in pine logging Slash can be a significant problem if they are not managed. Board of Forestry Technical Rule Addendum Number 3 describes the considerations that the RPF preparing a THP shall use in developing alternatives for treating pine brood material. The addendum also describes methods of treating pine brood material that may be used to meet the objectives of this rule. The RPF may propose or the Director may require hazard reduction treatments to mitigate significant adverse Impacts of insects breeding in pine brood material at any time during the life of a THP.

BOARD OF FORESTRY TECHNICAL RULE ADDENDUM NO. 3 BROOD MATERIAL

A. Hazard Determination -

- Tree mortality and top killing result when Ips beetle populations reproduce and increase in pine brood material 1/ and then leave this material and attack pines in the residual stand. Hazard increases with the amount of pine brood material present.

- Any suitable breeding material, including pine logs from recently felled trees, represents a hazard as long as it remains on site long enough for the beetles to complete a life cycle in it. During suitable weather, the life cycle may be as short as five weeks. Piling of brood material is more hazardous than leaving it spread-out on the ground.

- Timing of brood material production may influence hazard. Hazard is presumed to be highest when pine brood material is produced from February through June and moderate when produced at other times of

CALIFORNIA FOREST PRACTICE RULES

the year. At no time is hazard presumed to be low. In some parts of the Southern Forest District, hazard is presumed to be high year round, regardless of when the brood material was produced.

- Age, size, and species of residual trees influence hazard. Young pole size stands of pine are most susceptible to damage. Tree species other than pine are not damaged by insects that breed in pine brood material. Brood material from tree species other than pine generally does not contribute to the build-up of damaging beetle populations.
- Low vigor residual trees are at greatest risk. Historically, drought stressed, suppressed, and overstocked stands have been identified as high risk. Off-site, diseased, damaged, and overmature trees are also at risk.
- If damaging insect populations are high, hazard will be greater. High beetle populations have the potential to damage more than just low vigor trees. Chronic pine mortality in the area should be evaluated to determine if high beetle populations are present. An established Zone of Infestation for pine bark beetles implies that conditions are appropriate for the build-up of beetle populations.
- Potential for the spread of damaging insects to adjacent ownerships should be considered. The closer the ownership, the greater the risk. Generally, ownerships beyond one quarter of a mile will have little or no risk.
- Value of residual trees should be considered. How much loss to residuals is acceptable?

B. Hazard Reduction Treatment Alternatives -

Any treatment to reduce hazard should apply to the entire area where a hazard has been determined to exist, including the area where lopping for fire hazard reduction has been used. Treatment alternatives include modification of the brood material so that it is less suitable as a breeding site for beetles or methods to reduce beetle populations that have developed. Specific Treatment Alternatives applied to pine brood material are as follows:

(1) The following treatments are acceptable provided they are completed before insect broods emerge from infested material. During weather that is suitable for brood development, a five week window is the maximum time that should elapse between creation of brood material and its treatment by one of the following methods: brood material can be removed from the site for processing or disposal; if left on-site, it can be piled and burned, chipped, debarked, treated with an appropriate pesticide, or piled and covered with clear plastic. If brood material is piled and covered, the plastic used must be a minimum of 6 mil thick; piles must be completely sealed by the plastic so that there are no openings to the outside and remain covered for 6 months (or 4 months if at least 2 summer months are included).

(2) The following treatment is acceptable, provided it is completed as soon after brood material creation as is practical, but not later than one week. Lop all branches from the sides and tops of those portions of main stems which are 3" or more in diameter. Branches shall be scattered so that stems have maximum exposure to solar radiation. Do not pile brood material. Lopped stems could also be cut into short segments to decrease drying time and further reduce hazard.

(3) Burying brood material will prevent it from being colonized by beetles, but may not prevent emergence of the beetles. Therefore, it must be buried before becoming infested. During suitable weather, brood material must be buried concurrent with its creation. "Suitable" weather depends upon location. In areas that receive snowfall, suitable weather generally exists from April 15-October 15. In other areas, suitable weather exists from March 1-November 30.

917.10, 937.10, 957.10 Locating and Reporting [All Districts]

Timber Operators, Timber Owners and RPFs, if any, employed on the operation, shall assist the State in determining the location of insect and disease outbreaks, and report such outbreaks to the Director or a representative of the Director.

Article 8 Fire Protection

918, 938, 958 Fire Protection [Coast, Northern, Southern]

When burning permits are required pursuant to PRC § 4423, Timber Operators shall:

- (a) Observe the fire prevention and control Rules within this article.
- (b) Provide and maintain fire suppression related tools and devices as required by PRC §§ 4427, 4428,

CALIFORNIA FOREST PRACTICE RULES

4429, 4431, and 4442.

(c) Submit each year, either before April 1st or before the start of Timber Operations, a fire suppression resources inventory to the Department as required by the Rules.

918.1, 938.1, 958.1 Fire Suppression Resource Inventory [All Districts]

The Fire Suppression Resource Inventory shall include, as a minimum, the following information:

(a) Name, address and 24-hour telephone number of an individual and an alternate who has authority to respond to Department requests for resources to suppress fires.

(b) Number of individuals available for firefighting duty and their skills.

(c) Equipment available for firefighting. The Fire Suppression Resource Inventory shall be submitted to the ranger unit headquarters office of the Department having jurisdiction for the timber operation.

918.3, 938.3, 958.3 Repealed [All Districts]

918.4, 938.4, 958.4 Smoking and Matches [All Districts]

Subject to any law or ordinance prohibiting or otherwise regulating smoking, smoking by persons engaged in Timber Operations shall be limited to occasions where they are not moving about and are confined to cleared Landings and areas of bare soil at least three feet (.914 m) in diameter. Burning material shall be extinguished in such areas of bare soil before discarding. The Timber Operator shall specify procedures to guide actions of his employees or other persons in his employment consistent with this subsection.

918.5, 938.5, 958.5 Lunch and Warming Fires [All Districts]

Subject to any law or ordinance regulating or prohibiting fires, warming fires or other fires used for the comfort or convenience of employees or other persons engaged in Timber Operations shall be limited to the following condition:

1. There shall be a clearance of 10 feet (3.05 m) or more from the perimeter of such fires and flammable vegetation or other substances conducive to the spread of fire.

2. Warming fire shall be built in a depression in the soil to hold the ash created by such fires.

3. The Timber Operator shall establish procedures to guide actions of his employees or other persons in their employment regarding the setting, maintenance, or use of such fires that are consistent with (a) and (b) of this subsection.

918.6, 938.6, 958.6 Posting Procedures [All Districts]

Timber Operators shall post notices which set forth lists of procedures that they have established consistent with Sections 918.4 [938.4, 958.4] and 918.5 [938.5, 958.5]. Such notices shall be posted in sufficient quantity and location throughout their logging areas so that all employees, or other persons employed by them to work, shall be informed of such procedures. **Coast and Northern:** Timber Operators shall provide for diligent supervision of such procedures throughout their operations. **Southern:** Timber Operators shall provide for diligent supervision and enforcement of fire prevention Rules throughout their operations.

918.7, 938.7, 958.7 Blasting and Welding [All Districts]

Timber Operators shall provide for a diligent fire watch service at the scene of any blasting or welding operations conducted on their logging areas to prevent and extinguish fires resulting from such operations.

918.8, 958.8 Inspection for Fire [Coast, Southern]

The Timber Operator or his/her agent shall conduct a diligent aerial or ground inspection within the first two hours after cessation of felling, Yarding, or loading operations each day during the dry period when fire is likely to spread. The person conducting the inspection shall have adequate communication available for prompt reporting of any fire that may be detected.

938.8 Inspection for Fire [Northern]

(a) The Timber Operator or his/her agent shall conduct a diligent aerial or ground inspection within the first two hours after cessation of felling, Yarding, or loading operations each day during the dry period when fire

CALIFORNIA FOREST PRACTICE RULES

is likely to spread. The person conducting the inspection shall have adequate communication available for prompt reporting of any fire that may be detected.

918.10, 938.10, 958.10 Cable Blocks [All Districts]

During the period when burning permits are required, all tail and side blocks on a cable setting shall be located in the center of an area that is either cleared to mineral soil or covered with a fireproof blanket that is at least 15 ft. in diameter. A shovel and an operational full five-gallon back pump or a fire extinguisher bearing a label showing at least a 4A rating must be located within 25 feet of each such block before Yarding.

Article 9 Wildlife Protection Practices

919, 939, 959 Wildlife Practice [All Districts]

Timber Operations shall be planned and conducted to maintain suitable habitat for wildlife species as specified by the provisions of this Article. These provisions are in addition to those directly or indirectly provided in other Rules of the Board.

919.1, 939.1, 959.1 Snag Retention [All Districts]

Within the logging area all snags shall be retained to provide wildlife habitat except as follows:

(a) If required by the Director during the review of a THP, snags over 20 ft. in height and 16 in. dbh shall be felled in the following locations:

(1) Within 100 feet of main ridge tops that are suitable for fire suppression and delineated on a THP map.

(2) For hazard reduction within 100 feet of all public roads, permanent roads, seasonal roads, Landings, and railroads.

(b) Where federal and state safety laws and regulations require the felling of snags.

(c) Within 100 feet of structures maintained for human habitation.

(d) Merchantable snags in any location as provided for in the plan, or

(e) Snags whose falling is required for insect or disease control.

(f) When proposed by the RPF; where it is explained and justified that there will not be a significant Impact to wildlife habitat needs or there is a threat to human health or safety, including fire where the Director determines a high hazard exists.

919.2, 939.2, 959.2 General Protection of Nest Sites [All Districts]

The following general standards for protection of Sensitive species shall apply:

(a) A pre-harvest inspection will normally be required when it is known or suspected that the minimum Buffer Zone surrounding an active nest of a Sensitive species is in or extends onto an area proposed for Timber Operations. When the CAL FIRE is already familiar with the site, the Director, after consultation with the CDFW, may waive this requirement.

(b) During Timber Operations, Nest Tree(s), designated perch trees(s), screening tree(s), and replacement trees(s), shall be left standing and unharmed except as otherwise provided in these following Rules.

(c) Timber Operations shall be planned and operated to commence as far as possible from occupied Nest Trees unless explained and justified by the RPF in the THP.

(d) When an occupied Nest Site of a listed bird species is discovered during Timber Operations, the Timber Operator shall protect the Nest Tree, screening trees, perch trees, and replacement trees and shall apply the provisions of subsections (b) and (c) above and shall immediately notify the CDFW and the CAL FIRE. An amendment that shall be considered a minor amendment to the timber harvesting plan shall be filed reflecting such additional protection as is agreed between the operator and the Director after consultation with the CDFW.

919.3, 939.3, 959.3 Specific Requirements for Protection of Nest Sites [All Districts]

The following requirements shall apply to Nest Sites containing active nests and not to Nest Sites

CALIFORNIA FOREST PRACTICE RULES

containing only abandoned nests.

(a) Buffer Zones shall be established around all Nest Trees containing active nests. The Buffer Zones shall be designed to best protect the Nest Site and nesting birds from the effects of Timber Operations. In consultation with the CDFW, and as approved by the Director, an RPF or supervised designee shall flag the location of the boundaries of the Buffer Zone, and the configuration of the Buffer Zone. Consultation with the CDFW shall be required pursuant to 14 CCR 898. Consideration shall be given to the specific habitat requirements of the bird species involved when configuration and boundaries of the Buffer Zone are established.

(b) The size of the Buffer Zone for each species shall be as follows:

(1) For the Bald Eagle and Peregrine Falcon, the Buffer Zone shall be a minimum of ten acres in size. The Director may increase the Buffer Zone beyond 40 acres in size so that Timber Operations will not result in a "take" of either species. The Director shall develop the Buffer Zone in consultation with the CDFW and the RPF.

(2) For the Golden Eagle, the Buffer Zone shall be a minimum of eight acres in size.

(3) For the Great Blue Heron and Great Egret, the Buffer Zone shall consist of the area within a 300-foot radius of a tree or trees containing a group of five or more active nests in close proximity as determined by the CDFW.

(4) For the Northern Goshawk, the Buffer Zone shall be a minimum of five acres in size. When explained and justified in writing, the Director may increase the size of the Buffer Zone to a maximum of 20 acres when necessary to protect nesting birds.

(5) For the Osprey, the Buffer Zone shall be up to five acres in size. When explained and justified in writing, the Director may increase the size of the Buffer Zone to a maximum of 18 acres when necessary to protect nesting birds.

(c) The following year around restrictions shall apply within the Buffer Zone.

(1) For the Bald Eagle, no clear cutting is allowed within the Buffer Zone. Selection, commercial thinning, sanitation-salvage, and the shelterwood regeneration method, except for the removal step, are permitted if all trees are marked prior to preharvest inspection. All Nest Trees containing active nests, and all designated perch trees, screening trees and replacement trees, shall be left standing and unharmed.

(2) For the Golden Eagle, no clear cutting is allowed within the Buffer Zone. All Nest Trees containing active nests, and all designated perch trees, screening trees, and replacement tree, shall be left standing and unharmed.

(3) For the Great Blue Heron and Great Egret, all Nest Trees containing active nests shall be left standing and unharmed.

(4) For the Northern goshawk, designated Nest Trees, screening trees, perch trees, and replacement trees shall be left standing and unharmed. Only the commercial thinning, sanitation-salvage, and selection regeneration methods are permitted in the Buffer Zone.

(5) For the Osprey, all designated Nest Trees, perch trees, screening trees, and replacement trees shall be left standing and unharmed. If the RPF believes that retention is not feasible, he/she may propose construction of an artificial nest structure as an alternative.

(6) For the Peregrine Falcon, where timber provides part of the immediate nesting habitat, special cutting prescriptions may be required by the Director on an area up to ten acres in size immediately surrounding the nest. The cutting prescriptions shall protect the nesting habitat.

(d) Critical periods are established for each species and requirements shall apply during these critical periods as follows:

(1) For the Bald Eagle, the critical period is January 15 until either August 15 or four weeks after fledgling, as determined by the Director. During this critical period, no Timber Operations are permitted within the Buffer Zone. Exceptions may be approved by the Director, after consultation with the CDFW to allow hauling on existing roads that normally receive use within the Buffer Zone during the critical period.

(2) For the Golden Eagle, the critical period is January 15 until April 15 for active nests, and extended from April 15 until either September 1 or until the birds have fledged for occupied nests. During this critical period, hauling on existing roads that normally receive use during the critical period is permitted. Other operations are not permitted within the Buffer Zones.

(3) For the Great Blue Heron and Great Egret, the critical period is February 15 until July 1 for

CALIFORNIA FOREST PRACTICE RULES

coastal counties south of and including Marin County. For all other areas, the period is from March 15 through July 15. During this critical period, Timber Operations within the Buffer Zone shall be staged with a gradual approach to the nest.

(4) For the Northern Goshawk, the critical period is from March 15 until August 15. During this critical period, no Timber Operations are permitted; however, new road construction is permitted if the Director determines that there is no feasible alternative. Exceptions may be approved by the Director after consultation with the CDFW to allow hauling on existing roads that normally receive use within the Buffer Zone during the critical period.

(5) For the Osprey, the critical period is March 1 to April 15 for active nests in coastal counties including Mendocino County and those south of it. This period is extended from April 15 until August 1 for occupied nests. For all other areas, the critical period is March 15 until May 1 for active nests, and is extended from May 1 to August 15 for occupied nests. During the critical period, at Nest Sites where Osprey have shown historical tolerance to disturbance, Timber Operations are permitted using a gradual approach to the nest, except that no cutting is permitted. Where Osprey are determined by the Director to be intolerant to Timber Operations, no Timber Operations are permitted within the Buffer Zone unless the Director determines that there are no feasible alternatives.

(6) For the Peregrine Falcon, the critical period is February 1 until April 1 for active nests, and is extended until July 15 for occupied nests. During the critical period, no Timber Operations are permitted within the Buffer Zone. However, when the Director, after consultation with the CDFW determines that Peregrines have shown a tolerance to hauling activity in the past, hauling on existing roads that normally receive use during the critical period within the Buffer Zone is permitted.

(e) The following requirements shall apply to helicopter logging during the critical period.

(1) For the Bald Eagle, helicopter Yarding within one-quarter mile radius of the Nest Tree is prohibited. Helicopter Yarding between one-quarter and one-half mile of the Nest Tree is permitted when Timber Operations are conducted so that helicopter Yarding gradually approaches the one-quarter mile radius limit.

(2) For the Golden Eagle and Northern Goshawk, helicopter Yarding within one-quarter mile radius of the nest is prohibited.

(3) For the Osprey, helicopter Yarding within one-quarter mile radius of the nest is prohibited between April 15 and June 15.

(4) For the Peregrine Falcon, helicopter Yarding is prohibited within one-half mile of the nest.

919.4, 939.4, 959.4 Non-listed Species [All Districts]

Where significant adverse Impacts to non-listed species are identified, the RPF and Director shall incorporate feasible practices to reduce Impacts as described in 14 CCR 898.

919.5, 939.5, 959.5 Alternatives [All Districts]

The RPF may propose alternatives to the requirements of this chapter, and the Director may approve such alternatives provided all of the following conditions are met:

(a) The RPF develops the alternative in consultation with the CDFW.

(b) The Director consults with the CDFW and makes findings that the alternative conforms to (c), below, prior to approving the alternative.

(c) The alternative will provide protection for nesting birds and their nesting sites equal to or greater than the protection that would be afforded by the application of the normal Rules set forth in this chapter.

919.9, 939.9 Northern Spotted Owl [Coast, Northern]

Every proposed timber harvesting plan, NTMP, WFMP, Conversion Permit, Spotted Owl Resource Plan, or major amendment located in the Northern Spotted Owl Evaluation Area or within 1.3 miles of a known northern spotted owl Activity Center outside of the Northern Spotted Owl Evaluation Area shall follow one of the procedures required in subsections (a)-(d) below for the area within the Plan boundary as shown on the Plan map and also for adjacent areas as specified within this section. The submitter may choose any alternative (a)-(d) that meets the on-the-ground circumstances. The required information shall be used by the Director to evaluate whether or not the proposed activity would result in the "take" of an individual northern

CALIFORNIA FOREST PRACTICE RULES

spotted owl.

When subparagraphs (a) is used, the Director, prior to approval of a Plan, shall consult with an SOE and conduct an independent review. An SOE may aid the RPF in fulfilling the requirements within subdivision (d). The SOE may make written recommendations regarding whether the retained habitat configuration and protection measures proposed in the Plan will prevent a take.

In consultation with the SOE, the Director may adjust standards established by this section based on site specific circumstances in a manner which is consistent with information collected on owl behavior in California, and the prohibitions of the Federal Endangered Species Act.

(a) If the project proponent requests preliminary review of the proposed operation or Spotted Owl Resource Plan prior to filing, the proponent shall consult with an SOE to evaluate whether the proposed operation would result in the taking of an individual northern spotted owl. This evaluation is preliminary to and separate from the final "take" determination to be made under 14 CCR § 919.10 [939.10]. In making that evaluation:

(1) The SOE shall apply the criteria set forth in 14 CCR § 919.10 [939.10].

(2) The SOE may request that the submitter provide additional information which the SOE finds necessary to evaluate if a "take" would occur, provided that the SOE states the type of information needed, the purpose of the information, and the level of accuracy necessary to meet the stated purpose.

(3) If the SOE concludes that no prohibited taking would occur, the SOE shall inform the submitter as soon as practicable and shall document the decision and the information which was relied upon by the SOE in the above evaluation. Reference data shall be readily available for the Director's review upon request;

(4) If the SOE concludes that the proposed timber operation or Spotted Owl Resource Plan would result in a taking, he or she shall inform the submitter as soon as practicable and shall comply with 14 CCR § 919.10(c) [939.10(c)] within 10 working days of making this determination.

(5) Requests for pre-filing consultation shall be handled in the order in which received.

(b) If the plan submitter proposes to proceed under an Incidental Take Permit, Safe Harbor Agreement, participation in a Habitat Conservation Plan, or any other permit covering the northern spotted owl issued by the USFW or the CDFW, the submitter shall supply a copy of the permit upon the Department's request.

(c) If the submitter proposes to proceed pursuant to the outcome of a discussion with the U.S. Fish and Wildlife Service, the submitter shall submit a letter prepared by the RPF that the described or proposed management prescription is acceptable to the USFWS.

(d) Where an Activity Center has been located within the Plan boundary or within 0.7 miles (within the range of coast redwood) or 1.3 miles (outside of the range of coast redwood) of that boundary, the RPF shall determine and document in the plan: (i) Activity Center-specific protection measures to be applied during Timber Operations and (ii) Northern Spotted Owl Habitat which meets the standards of the appropriate region, that will be retained after the proposed operations are completed to avoid take consistent with guidance provided by the listing agency(s) or Director, or (iii) propose alternative take avoidance standards based upon substantial site-specific information for review and approval by the Director.

§ 919.10 [939.10] Take of Northern Spotted Owl.

The Director shall apply the following criteria to the information provided by the plan submitter and obtained during the review period to make a finding as to whether the Timber Operations, as proposed, will "take" an individual northern spotted owl.

(a) The Director shall determine that the proposed habitat modification would result in "harm" to an individual spotted owl if any of the following conditions exist.

(1) Feeding habits would be significantly impaired because prey base or ability to catch prey would be adversely altered;

(2) Breeding success would be significantly impaired because of a reduction in surrounding owl habitat before the young have had an opportunity to successfully disperse from their nesting site;

(3) Nesting behavior would be significantly impaired because the Nest Site or adjoining area up to

CALIFORNIA FOREST PRACTICE RULES

500 feet from the Nest Site would be adversely altered; or

(4) Sheltering (which includes roosting, feeding, and nesting) would be significantly impaired because the ability to escape predators, survive severe weather, or find appropriate microclimates would be adversely altered.

(b) The Director shall determine that an individual northern spotted owl would be "harassed" by the proposed Timber Operations if there is a likelihood that any of the following conditions exist:

(1) Feeding habits would be significantly disrupted because the prey base or the ability to catch prey would be impaired;

(2) Breeding success would be significantly disrupted;

(3) Nesting behavior would be significantly disrupted because activities would be conducted within 500 feet of a Nest Site; or

(4) Sheltering (which includes roosting, nesting, or feeding) would be significantly disrupted because the ability to escape predators, survive severe weather, find appropriate microclimates would be adversely altered.

(c) If the Director concludes that the proposed operations will result in a taking of the owl, he/she shall provide the plan submitter with the following information:

(1) The reasons for the determination, including an analysis of the factors set forth in this section;

(2) The information which was relied upon and which was instrumental in making the determination; and

(3) Recommendations for minimum modifications to the proposed operations which would be necessary to bring the Impacts to a level at which "take" would not occur.

919.11 Marbled Murrelet Protective Measures [Coast]

Where there is evidence of an active murrelet site in or adjacent to the THP area, or where there is evidence of a potential Impact to a murrelet, the Director shall consult with CDFW as to whether the proposed THP will result in a "take" or "jeopardy" (pursuant to the California Endangered Species Act) of the murrelet before the Director may approve or disapprove a THP. Biological Assessments submitted with the THP that are prepared according to the CDFW Guidelines for Consultation shall be provided to the CDFW during consultation. If CDFW determines jeopardy or a take will occur as a result of operations proposed in the THP, the Director shall disapprove the THP unless the THP is accompanied by authorization by a wildlife agency acting within its authority under state or federal endangered species acts.

919.12, 939.12, 959.12 Sensitive Species Classification [All Districts]

The Board has the responsibility under the FPA to provide protection to all species occurring in the state's forestlands. The procedure to identify those species that warrant special protection during Timber Operations is described as follows:

(a) The public or public agencies may petition the Board to classify a species as a "sensitive species." For the Board to consider such a petition, it must contain a discussion of the following topics:

(1) Range and distributional status of the species which includes an assessment of occurrence in Timberland as defined by the FPA and the Rules.

(2) Indices of population trends describing the abundance of the species.

(3) Biotic and abiotic factors affecting the population viability or status of the species. Specific attention should be given to factors related to forest management and harvesting. This should include threats to population and habitat viability, including direct, indirect, and cumulative effects from these and other threats.

(4) Habitat availability and trends that include, but are not limited to, an assessment of the following as appropriate:

(A) Dependence on general habitat conditions altered by typical forest management activities and projected time for habitat recovery.

(B) Dependence on special habitat elements adversely Impacted by Timber Operations,

(C) Habitat continuity and juxtaposition requirements as an evaluation of sensitivity to habitat fragmentation.

(5) Suggested feasible protective measures required to provide for species protection.

CALIFORNIA FOREST PRACTICE RULES

(6) Other information specific to the species proposed that the petitioner believes to be relevant in assisting the Board to evaluate the petition.

(7) Sources of information relied upon to complete the petition.

(8) Recommended forest practice Rules to provide guidance to RPFs, LTOs, landowners and the Director on species protection.

(9) The potential economic Impacts of classifying a species sensitive.

(b) The Board will consult with the USFWS, the California Fish and Game Commission, the CDFW, and others as appropriate. After consultation the Board shall classify a species as sensitive after a public hearing if it finds:

(1) The California population requires Timberland as habitat for foraging, breeding, or shelter, and

(2) The California population is in decline or there is a threat from Timber Operations, and

(3) Continued Timber Operations under the current Rules of the Board will result in a loss of the California population viability.

(c) The Board shall consult with the USFWS, the CDFW, and others as appropriate. After consultation and a public hearing, the Board will declassify a species as sensitive if it no longer meets the criteria for classification.

(d) The Board shall consider, and when possible adopt, regulations using the best available scientific information to establish the feasible mitigations for protection of the species at the same time such species is classified sensitive.

(e) Where Rules are not adopted for the protection of the species at the time of classification, the Board shall begin development of proposed regulations for protection of the species.

Within one year of the classification of a species as sensitive, the Board shall hold a hearing on proposed regulations to establish the protection standards for that species according to the best available scientific information.

959.15 Protection of Wildlife Habitat [Southern]

(a) Where present at time of timber harvest, 400 sq. ft. basal area of oak per 40 acres should be retained and protected, giving preference to deciduous oaks. Oaks should be retained on areas designated by CDFW as deer migration corridors, holding areas, or key ranges when consistent with good forestry practices.

919.16, 939.16, 959.16 Late Succession Forest Stands [All Districts]

(a) When late succession forest stands are proposed for harvesting and such harvest will significantly reduce the amount and distribution of late succession forest stands or their functional wildlife habitat value so that it constitutes a significant adverse Impact on the environment as defined in Section 895.1, the RPF shall provide habitat structure information for such stands. A statement of objectives over time shall be included for late succession forest stands on the ownership. The THP, SYP, or NTMP shall include a discussion of how the proposed harvesting will affect the existing functional wildlife habitat for species primarily associated with late succession forest stands in the plan or the planning watershed, as appropriate, including Impacts on vegetation structure, connectivity, and fragmentation. The information needed to address this subsection shall include, but is not limited to:

(1) - A map(s) showing: A) late succession forest stands within the planning watershed and any other stands that provide functional wildlife habitat for species primarily associated with late succession forest stands that are on the ownership, B) those stands which are currently proposed to be harvested, and C) known stands on other ownerships.

(2) - A list of fish, wildlife and listed species known to be primarily associated with the late succession forest stands in the planning watershed(s) compiled by the RPF or supervised designee using the "California Wildlife Habitat Relationships System" (WHR), the California Natural Diversity Database, and local knowledge of the planning watershed.

(3) - Description of functional wildlife habitat elements that are important for fish, wildlife and listed species primarily associated with late succession forest stands within the planning watershed(s).

(4) - A description of the structural characteristics for each late succession forest stand and any other stands that provide functional wildlife habitat for species primarily associated with late succession forest stands within the planning watershed including a discussion of important functional wildlife habitat elements

CALIFORNIA FOREST PRACTICE RULES

identified in (3). Methods used to develop the description, which may be an ocular estimate, shall also be described.

(5) - A description of the functional wildlife habitat objectives, such as anticipated long-term landscape patterns, stand structure for late succession forest stands and any other stands that provide functional wildlife habitat for species primarily associated with late succession forest stands, and a discussion of anticipated recruitment procedures for important functional wildlife habitat elements. Coordination of functional wildlife habitat objectives on landscape features among ownerships within mixed-ownership planning watersheds is encouraged.

(6) - An analysis of the long-term significant adverse effects on fish, wildlife, and listed species known to be primarily associated with late succession forests.

(b) Where Timber Operations will result in long-term significant adverse effects on fish, wildlife, and listed species known to be primarily associated with late succession forests in a THP, SYP, NTMP or planning watershed, feasible mitigation measures to mitigate or avoid such long-term significant adverse effects shall be described and incorporated in the THP, SYP or NTMP. Where long-term significant adverse effects cannot be avoided or mitigated, the THP, SYP, or NTMP shall identify the measures that will be taken to reduce those remaining effects and provide reasons for overriding concerns pursuant to 14 CCR Section 898.1 (g), including a discussion of the alternatives and mitigation considered.

(c) A THP, SYP, or NTMP submitter may request that the Director waive subsection (a) above. The Director, after conferring with review team agencies with jurisdiction, may waive subsection (a) above when substantial evidence is presented that would support a determination that post-harvest late succession forest stands or functional wildlife habitat will continually provide adequate structure and connectivity to avoid or mitigate long-term significant adverse effects on fish, wildlife, and listed plant species known to be primarily associated with late succession forest stands within the planning watersheds.

Article 10 Violations of Rules Prior to Changes

920, 940, 960 Violations of Rules Prior to Changes [All Districts]

Amendment, modification, or repeal of Rules shall not, unless otherwise provided, bar action on prior violations of Rules as they stood at the time of violation.

Article 11 Coastal Commission Special Treatment Areas

921, 961 Coastal Commission Special Treatment Areas [Coast, Southern, Special Treatment Area]

The purpose of this article is to protect the natural and scenic qualities as reflected in the criteria and objectives for each of the Coastal Commission Special Treatment Areas designated and adopted by the California Coastal Commission on July 5, 1977, while at the same time allowing management and orderly harvesting of timber resources within these areas. In addition to the statutes and other regulations governing timber harvesting, the following practices are required when conducting Timber Operations in such Special Treatment Areas.

921.1 Preliminary Field Work and Timber Harvesting Plans [Coast, Special Treatment Area]

(a) The following preliminary field work shall be required in the Coastal Commission Special Treatment Areas and shall be completed prior to submission of the plan to the Director:

(1) When a boundary of a Coastal Commission Special Treatment Area is within or contiguous to a plan area, the boundary shall be clearly identified on the ground by the RPF preparing the plan or supervised designee, with paint, flagging, or other suitable means.

(2) All tractor roads and skid trails that require substantial soil displacement shall be clearly marked on the ground with flagging or other appropriate marking.

(3) The boundary of all slides and areas with visible evidence of slope instability which extend to the Watercourse and lake protection zone shall be flagged or otherwise adequately marked on the ground.

(4) The following wildlife consideration shall be followed:

(A) Live trees, as designated on the ground by the CDFW, CAL FIRE, or the RPF or supervised designee with visible evidence of current use as nesting sites by hawks, owls, or waterfowl shall

CALIFORNIA FOREST PRACTICE RULES

not be marked for cutting.

(5) In applying the Rules, the RPF shall, when selecting feasible alternatives required by 14 CCR § 898, follow the criteria and management objectives used by the Coastal Commission in selecting that area for special treatment (see Title 14, California Code of Regulations, § 912).

(b) The following shall be adhered to in submitting plans for Coastal Commission Special Treatment Areas:

(1) Plan maps shall be at a scale of at least 4 inches to the mile (6.3 cm per km).

(2) Plan maps must show the location of and identify the following: All log Landings proposed to be used, and all main skid trails, all Logging Roads, all Watercourses, lakes, marshes and boundaries of Coastal Commission Special Treatment Areas within or contiguous to the plan area.

(3) An initial inspection of the area in which Timber Operations are to be conducted shall be made within 10 days from the date of filing of the plan, or such longer period as may be mutually agreed upon by the Director and the person submitting the plan. The RPF who prepared the plan shall attend the initial inspection. The Timber Owner and Timber Operator or their agents should attend the initial inspections.

961.1 Preliminary Field Work and Timber Harvesting Plans [Southern, Special Treatment Area]

(a) The following preliminary field work shall be required in the Coastal Commission Special Treatment Areas and shall be completed prior to submission of the plan to the Director.

(1) When a boundary of a Coastal Commission Special Treatment Area is within or contiguous to a plan area, the boundary shall be clearly identified on the ground by the RPF preparing the plan or supervised designee, with paint, flagging, or other suitable means.

(2) All timber proposed for harvest shall be clearly marked with paint at points approximately 4 1/2 feet (1.37 m) above the ground and at ground level.

(3) The following wildlife considerations shall be followed:

(A) Live trees, as designated on the ground by the CDFW, CAL FIRE, or the RPF or supervised designee, with visible evidence of current use as nesting sites by hawks, owls, or waterfowl shall not be marked for cutting.

(B) Live trees as designated on the ground by the CDFW, CAL FIRE, or the RPF or supervised designee, with visible evidence of nesting by eagles, osprey, or any endangered species, as identified by the CDFW, shall not be marked for cutting.

(C) Live trees constituting a rookery for herons and/or egrets shall not be marked for cutting unless authorization in writing from the CDFW is granted to the Timber Owner.

(4) All Logging Roads proposed to be constructed or Reconstructed, main skid trails and those minor skid trails that would require or result in substantial soil displacement, and Landing locations shall be clearly marked on the ground with flagging or other appropriate marking, keyed to the various Projects.

(5) The boundary of the WLPZs shall be flagged or otherwise marked on the ground and shall include all slides and areas with visible evidence of slope instability which extend to the WLPZ.

(b) The following requirements shall be adhered to in submitting plans in Coastal Commission Special Treatment Areas:

(1) Plan maps shall be at a scale of at least 4 inches to the mile (6.3 cm per km).

(2) The plan map must show the location and identify the following: All log Landings proposed to be used, and all main skid trails, all Logging Roads, all Watercourses, lakes, marshes and boundaries of Coastal Commission Special Treatment Areas within or contiguous to the plan area.

(3) An initial inspection of the area in which Timber Operations are to be conducted shall be made within 10 days from the date of filing of the plan, or such longer period as may be mutually agreed upon by the Director and the person submitting the plan. The RPF who prepared the plan shall attend the initial inspection. The Timber Owner and Timber Operator or their agents should attend the initial inspections.

(4) In applying the Rules the RPF shall, when selecting feasible alternatives required by 14 CCR § 898, follow the criteria and management objectives used by the Coastal Commission in selecting that area for special treatment (See 14 CCR § 912.)

921.2 Exemptions from Timber Harvesting Plan Requirements [Coast, Special Treatment Area]

To ensure that the protection necessary to maintain the integrity of Coastal Commission Special Treatment

CALIFORNIA FOREST PRACTICE RULES

Areas is achieved, the following requirements shall apply to the Timber Operations exempt from filing of THPs under 14 CCR 1038.

(a) The requirements of 14 CCR 921.1(a) and (b) shall apply with the exception that, at the discretion of the Director, an initial inspection may not be required. Harvesting of Christmas trees are exempt from timber marking requirements.

(b) The Director shall acknowledge in writing, and within 10 days, acceptance or rejection of the notice of Timber Operations. Timber Operations shall not commence until the Director's acceptance has been received by the person who filed the notice.

(c) The requirements of PRC 4585, Completion Report, and PRC 4587, Stocking Reports, shall apply to exempt operations within the Coastal Commission Special Treatment Areas.

961.2 Exemptions from Timber Harvesting Plan Requirements [Southern, Special Treatment Area]

Notwithstanding 14 CCR 1038, exemptions from plan filing requirements in the Coastal Commission Special Treatment Areas shall only be allowed for minor operations where no live trees are cut.

921.3 Silvicultural Methods [Coast, Special Treatment Area]

The objective of this Section is to prescribe silvicultural methods that will protect the long-term productivity of soils and Timberlands in Coastal Commission Special Treatment Areas and protect the natural and scenic qualities of these areas. The following silvicultural methods as prescribed below will be applied in Coastal Commission Special Treatment Areas. 14 CCR 913 through 913.6 defines these methods.

(a) Commercial Thinning or Selection Methods: When the commercial thinning or the selection silvicultural method is used the following standards are required:

(1) For an initial entry into an even-aged stand, leave a well distributed timber stand after cutting and logging operations have been completed on the cut area at least forty (40) percent by number of those trees eighteen (18) inches and more d.b.h. present prior to commencement of current Timber Operations. Leave trees shall be thrifty coniferous trees which are free from substantial damage caused by Timber Operations, and leave trees shall have the characteristics of a "countable tree" as described in Section 4528(b). No conifer tree shall be cut which is more than seventy-five (75) feet from a leave tree twelve (12) inches d.b.h. or larger located within the logging area.

(2) For timber stands where more than one age class is present, leave at least fifty (50) percent by number of those trees over twelve (12) in. d.b.h. Leave trees shall be thrifty coniferous trees which are free from substantial damage caused by Timber Operations. No conifer tree shall be cut which is more than seventy-five (75) ft. from a leave tree twelve (12) inches d.b.h or larger located within the logging area.

(3) A report of stocking as described in PRC 4587 shall be filed within six months following completion of work as described in the plan.

(b) Sanitation-Salvage Method: When the sanitation-salvage silvicultural method is used the following practices be required:

(1) Restrictions on time periods for subsequent Timber Operations shall not apply to the sanitation-salvage silvicultural method.

(2) A determined effort shall be made to regenerate any cut area during the first planting season following log removal. Necessary Site Preparation, planting or seeding shall be complete within the first planting season following logging, except where unusual and adverse weather conditions require extending Site Preparation and planting into the following planting season. Deficiencies in stocking shall be corrected by planting annually at least three times if necessary to meet the stocking standards in 14 CCR 921.4.

(3) Where the result of the cutting would have the effect of a clearcut all of the restrictions in this section pertaining to the use of clearcut shall apply, except for: 1) areas which are currently suffering severe damage due to insects or disease and the removal of the entire affected area is deemed necessary by a forest pathologist or forest entomologist and agreed to by the Director to prevent the spread of the disease or insects, or 2) except for areas which have recently been burned over and the RPF determined recovery of the affected area is unlikely.

(c) Clearcutting Method: The clearcutting method provides for harvesting of the entire existing timber stand in one harvest in an area. Every reasonable effort shall be made by the RPF to use silvicultural methods other than clearcutting to protect the natural and scenic values in the Coastal Commission Special

CALIFORNIA FOREST PRACTICE RULES

Treatment Areas. The clearcutting method is not authorized for Special Treatment Areas in the Southern Subdistrict of the Coast Forest District.

(1) The clearcutting method may be used when justified and explained in the plan and found in conformance by the Director for one or more of the following reasons:

(A) Leave trees would be subject to severe damage from sunburn, saltburn, and/or windthrow.

(B) Conifer stand improvement necessitates the clearing of a stand of hardwoods.

(C) Leave trees would prevent regeneration of the principal conifer species.

(D) Old growth stands where seventy (70) percent or more of the countable trees over thirty-six (36) inches d.b.h. are more than two hundred (200) years old.

(E) Timber stands where trees are infected with insects or diseases, and there is significant risk for substantial loss of standing timber or timber growth.

(2) Clearcut areas shall not exceed ten (10) acres in size, but may be enlarged to not more than fifteen (15) acres when explained and justified in the Plan, and when found in conformance with the Rules. Exceptions to the ten (10) acre size limit may be proposed by the RPF preparing the plan when in his or her judgment the result will be overall reduction of soil erosion due to logging and road construction, or when it is necessary to include "long corners" to take advantage of topography for a more natural logging unit.

(3) Clearcut areas of ten (10) acres or larger regardless of ownership shall be separated by a logical logging unit not less than three hundred (300) feet in width between the clearcut areas. Except for the sanitation-salvage, commercial thinning, and selection silvicultural method, no other harvesting shall take place in the unit adjacent to the clearcut areas until a fifty (50) percent crown cover of conifer tree species has been attained in the clearcut areas. Contiguous clearcuts may occur without regard to ownership only when the total combined acreage in the area clearcut is no more than ten acres.

(4) Straight boundaries and a quadrilateral appearance should be avoided in defining and logging the area to be clearcut. The outline of the clearcut area should, where possible, be in accordance aesthetically with natural pattern and features of the topography.

(5) The area to be clearcut must be clearly defined on the ground prior to initial inspection so the Department can readily determine if the full intent of the regulations will be complied with.

(6) No area previously cut under any other silvicultural method, except the sanitation-salvage method, shall be clearcut until ten (10) years have elapsed.

(7) Regeneration after clearcutting shall be obtained by using conifer trees or seed appropriate to the site. Site Preparation and the planting of seedlings and/or seeding shall be completed within the first planting season following logging except where unusual and adverse weather conditions require extending Site Preparation and planting into the following planting season. Deficiencies in stocking shall be corrected by planting annually, if necessary. Stocking requirements shall be met within five (5) years after completion of Timber Operations.

(d) Rehabilitation Cutting: Rehabilitation cutting may be applied to stands where the primary forest management objective is to reestablish full conifer stocking on lands where brush and hardwoods are the predominate species. Areas harvested for rehabilitation purposes must be significantly understocked with conifers prior to the proposed harvest. The Director may request that a report of stocking be submitted by the RPF prior to approval of the plan. This report will be requested when it cannot be mutually resolved on the ground that the area is significantly understocked. Restrictions applicable to clearcutting in 14 CCR 921.3(c) shall apply to rehabilitation cutting. Leave trees shall be marked in areas harvested for rehabilitation purposes.

(e) Fuelbreak/Defensible Space. These are projects where some trees and other vegetation and fuels are removed to create or maintain a shaded fuel break or defensible space in an area to reduce the potential for wildfires and the damage they might cause. Minimum Stocking Standards within the timber operating area shall be met immediately after harvest and shall be those found in 14 CCR § 912.7. The RPF shall describe in the Plan specific vegetation and fuels treatment, including timing, to reduce fuels to meet the objectives of a Community Fuelbreak Area or other objectives identified by the RPF with the written concurrence of a public fire agency and determined by the Director to be consistent with the purposes of this section. The Plan shall include RPF recommendations to protect the natural and scenic qualities of the resources that led to the designation of the area as a Special Treatment Area, including, but not limited to, treating slash in areas

CALIFORNIA FOREST PRACTICE RULES

highly visible to the public from a publicly accessible vantage point.

(f) Variable Retention may be utilized as described within 14 CCR § 953.4(d) to achieve the objectives of this section. The Plan shall include RPF recommendations to protect the natural and scenic qualities of the resources that led to the designation of the area as a Special Treatment Area, including, but not limited to, treating slash in areas highly visible to the public from a publicly accessible vantage point.

(g) Recutting of Logging Areas: Timber Operations for removal of trees may only be repeated on a logging area within less than ten (10) years after completion of a previous timber operation if minimum stocking standards have been met, the reasons for the operation are justified and explained in the plan, and the scenic and/or natural qualities of a stand would be enhanced by lighter or more frequent tree removal. In no instance shall stocking be reduced below the standards provided in 14 CCR 921.4 nor shall more than sixty (60) percent by numbers of those trees eighteen (18) inches and more d.b.h. and no more than fifty (50) percent by numbers of those trees over twelve (12) inches d.b.h. but less than eighteen (18) inches d.b.h. be removed within any one ten (10) year period.

(h) An Alternative Prescription shall be included in a Plan when, in the judgment of the RPF, an alternative Regeneration Method or Intermediate Treatment offers a more effective or more Feasible way of achieving the objectives of this section than any of the standard Silvicultural Methods provided above.

(1) The Alternative Prescription shall comply with 14 CCR §§ 913.6(b) and (d), and is subject to Director approval as described within 14 CCR § 913.6(e)

(2) If an Alternative Prescription will have the practical on-the-ground effect of a clearcut, regardless of name or description, then the acreage limitations, and requirement for separation by a typical logging unit, Yarding equipment limitations, exceptions, and Stocking requirements for the clearcut Regeneration Method described above, shall apply.

(3) Proposed modifications shall protect the natural and scenic qualities of the Coastal Commission Special Treatment Areas to at least the same extent as otherwise provided in these Rules, in consideration of the resources that led to the designation of the area as a Special Treatment Area.

On Timber Operations in which cutting has occurred within ten (10) years preceding the current operations, stumps which are the result of cutting trees within the preceding ten (10) years shall be counted as trees cut during the current operation in determining percent of trees cut. Timber Operations conducted under the Sanitation-Salvage Silvicultural Method, and the harvesting of minor forest products and incidental vegetation are exempt from the above provisions of this Section.

961.3 Silvicultural Methods [Southern, Special Treatment Area]

The objective of this Section is to prescribe silvicultural methods that will protect the long-term productivity of soils and Timberlands in Coastal Commission Special Treatment Areas and protect the natural and scenic qualities of these areas. The following silvicultural methods as prescribed below will be applied in Coastal Commission Special Treatment Areas. 14 CCR 953 through 953.13, defines these methods.

(a) Commercial Thinning or Selection Methods. When the commercial thinning or the selection silvicultural method is used the following standards are required:

(1) In the pine type, after Timber Operations have been completed, at least fifty (50) percent by number of those trees eighteen (18) inches or larger d.b.h. and at least fifty (50) percent by number of those trees twelve (12) inch d.b.h., but less than eighteen (18) inches d.b.h. must be left.

(2) In the redwood type, after Timber Operations have been completed, at least fifty (50) percent by number of those trees twelve (12) to eighteen (18) inches, eighteen (18) to thirty-two (32) inches and thirty-two (32) inches or larger d.b.h. must be left.

(3) These leave tree requirements shall be calculated from the timber stand existing prior to the commencement of Timber Operations. Leave trees shall be thrifty, coniferous trees which are dominant or co-dominant in crown class prior to timber harvesting or which have crowns typical of such dominant and co-dominant trees. They shall be free from substantial damage caused by Timber Operations. No cut conifer tree shall be more than seventy-five (75) feet from a leave tree over eighteen (18) inches d.b.h. located within the Logging Area.

(4) Immediately following completion of Timber Operations, stocking must meet or exceed stocking

CALIFORNIA FOREST PRACTICE RULES

standards of 14 CCR 961.4.

(5) A report of stocking as described in PRC 4587 shall be filed within six months following completion of work as described in the plan.

(b) When the Sanitation Salvage Silvicultural Method is used, the following practices are required:

(1) A determined effort shall be made to regenerate any cut area during the first planting season following log removal. Necessary Site Preparation, planting or seeding shall be completed within the first planting season following logging except where unusual and adverse weather conditions require extending Site Preparation and planting into the following planting season. Deficiencies in stocking shall be corrected by planting annually until final stocking requirements are met.

(2) Operations utilizing the sanitation salvage silvicultural method shall meet the basal area or point count stocking standards of 14 CCR 961.4 within five (5) years after the completion of Timber Operations.

(c) Fuelbreak/Defensible Space. Where some trees and other vegetation and fuels are removed to create or maintain a shaded fuel break or defensible space in an area to reduce the potential for wildfires and the damage they might cause. Minimum Stocking Standards within the timber operating area shall be met immediately after harvest and shall be those found in 14 CCR § 952.7. The RPF shall describe in the Plan specific vegetation and fuels treatment, including timing, to reduce fuels to meet the objectives of a Community Fuelbreak Area or other objectives identified by the RPF with the written concurrence of a public fire agency and determined by the Director to be consistent with the purposes of this section. The Plan shall include RPF recommendations to protect the natural and scenic qualities of the resources that led to the designation of the area as a Special Treatment Area, including, but not limited to, treating slash in areas highly visible to the public from a publicly accessible vantage point.

(d) Variable Retention may be utilized as described within 14 CCR § 953.4(d) to achieve the objectives of this section. The Plan shall include RPF recommendations to protect the natural and scenic qualities of the resources that led to the designation of the area as a Special Treatment Area, including, but not limited to, treating slash in areas highly visible to the public from a publicly accessible vantage point

(e) An Alternative Prescription shall be included in a Plan when, in the judgment of the RPF, an alternative Regeneration Method or Intermediate Treatment offers a more effective or more Feasible way of achieving the objectives of this section than any of the standard Silvicultural Methods provided above.

(1) The Alternative Prescription shall comply with 14 CCR §§ 953.6(b) and (d), and is subject to Director approval as described within 14 CCR § 953.6(e)

(2) Proposed modifications shall protect the natural and scenic qualities of the Coastal Commission Special Treatment Areas to at least the same extent as otherwise provided in these Rules, in consideration of the resources that led to the designation of the area as a Special Treatment Area.

921.4, 961.4 Stocking Requirements [Coast, Southern, STA]

The stocking standards for understocked Timberlands and substantially damaged Timberlands as provided for by 14 CCR 1080 through 1081.1 and 1085 through 1085.6 are not applicable in Coastal Commission Special Treatment Areas in the Coast [Southern] Forest District. After completion of Timber Operations one of the following stocking standards must be met:

(a) **Basal Area.** The average residual basal area, (measured in stems one (1) inch or larger in diameter Coast) shall be at least one hundred twenty-five (125) square feet per acre on Site I lands, at least one hundred (100) square feet per acre on Site II and Site III lands and at least seventy-five (75) square feet per acre on Site IV and V lands.

(b) **Point Count.** The area contains an average Countable Tree point count of at least two hundred (200) per acre on Site I and II lands, one hundred twenty-five (125) per acre on Site III lands, or one hundred (100) per acre on Site IV and V lands. The point count to be computed as follows:

(1) Each Countable Tree which is not more than four (4) inches d.b.h. counts one (1) point.

(2) Each Countable Tree over four (4) inches and not more than twelve (12) inches d.b.h. counts two (2) points.

(3) Each Countable Tree over twelve (12) inches d.b.h. counts as four (4) points

(4) Redwood root crown sprouts will be counted using the average stump Diameter one (1) foot above average ground level of the original stump from which the redwood root crown sprouts originate, counting one sprout for each one (1) foot of stump Diameter to a maximum of six (6) per stump.

CALIFORNIA FOREST PRACTICE RULES

(c) Site classification shall be determined by the RPF who prepared the plan.

(d) Rock outcroppings, Meadows and Wet Areas, or other areas not normally bearing timber shall not be considered as requiring stocking and are exempt from such provisions.

921.5 Logging Practices [Coast, Special Treatment Area]

The following logging practices shall be adhered to:

(a) Tractor Logging: Tractor logging and tractor preparation of tree layouts shall not be permitted on slopes averaging over 50% where the Erosion Hazard Rating is high or extreme and 60% where the Erosion Hazard Rating is low or moderate, unless it can be shown from past experience on the ground that tractor logging or other types of Skidding equipment will cause less disturbance than would result from a feasible alternative method.

(b) Roads: Rules contained in 14 CCR 923.2 through subsection [e] shall be adhered to with the following special requirements.

(1) Roads shall be single lane, not to exceed 16 ft. in width and generally the traveled surface shall be no more than 12 ft. (3.67 m) in width, except where alignment, safety, and equipment necessary to conduct the operation requires additional width. Deviations shall be explained and justified in the plan.

(2) Waste organic material such as uprooted stumps, cull logs, accumulations of limbs and branches, or non-merchantable trees shall not be buried in the main body of road fills. Such solid waste material may be used to secure the toe of a fill. Except for prepared crossings, including necessary approaches, sidecast or fill material shall not be placed in the Watercourse protection zone unless explained in the plan.

(3) Roads shall not be constructed through slide areas or areas with visible evidence of slope instability unless the alignment is the best available alternative and special design features are incorporated in the plan. There shall be provisions in the plan to maintain the design features or provisions to maintain or improve the stability of the area after completion of road use.

(4) Roads, Landings, cuts and fills shall be screened from direct view to the extent feasible by leaving screen trees and other vegetation between the disturbed areas and public areas utilized by substantial numbers of viewers.

(c) Soil disturbance, other than that incident to necessary road maintenance, whether with tractor or by cable means, shall not occur under excessively wet ground conditions that could result in substantial soil compaction and erosion.

(d) Notwithstanding the requirements of 14 CCR 1040, if in construction, rock outcroppings, springs and other physical factors require a change in roads, Landings and skid trail location, the location can be changed with the concurrence of an RPF, the operator and the Director's representative provided that such changes in location constitute minor deviations: that RPF shall provide written confirmation of such minor deviations which shall become a part of the plan. All changes in location constituting substantial deviations shall be submitted to the Director as amendments to the plan.

(e) Felling Practices: Up to 10% of the trees that are proposed for cutting may be substituted one for one with those proposed to be left uncut provided that the leave tree proportion, size class, distribution and general forest appearance of the residual stand as approved in the preliminary field work is preserved. Justification for the substitution standard shall be based on unavoidable tree damage, safety factors, lean of trees, location of obstructions or roads or openings insufficient to accommodate felled trees.

961.5 Logging Practices [Southern, Special Treatment Area]

The following logging practices shall be adhered to:

(a) Tractor logging and tractor preparation of tree layouts shall not be permitted on slopes averaging over 50% unless it can be shown that tractor logging will result in less soil disturbance than would result from an alternative method.

(b) Roads shall be single lane, and generally the travel surface shall be no more than 12 ft. (3.67 m) in width, except where alignment, safety, and equipment necessary to conduct the operation requires additional width. Deviations shall be explained and justified in the plan.

(c) An RPF may obtain a relocation of the main skid trails from that shown on the approved plan if the Director concurs after an inspection on the ground. Such relocation may be treated as a minor deviation with the plan so amended.

CALIFORNIA FOREST PRACTICE RULES

(d) Roads shall not be constructed through slide areas or areas with visible evidence of slope instability unless the alignment is the best available alternative and special design features are incorporated in the plan. There shall be provisions in the plan to maintain the design features or provisions to maintain or improve the stability of the area after completion of the use.

(e) Roads, Landings, cuts and fills shall be screened from direct view to the extent feasible by leaving screen trees and other vegetation between the disturbed areas and public areas utilized by substantial numbers of viewers.

(f) Soil disturbance, other than that incident to necessary road maintenance, whether with tractor or by cable means, shall not occur under excessively wet ground conditions that could result in substantial soil compaction and erosion.

921.6 Hazard Reduction [Coast, Special Treatment Area]

(a) Lopping: Except in the southern subdistrict, to reduce fire hazards, maintain soil fertility, reduce erosion, and improve visual appearance, all Slash and debris created by the current operations and within 300 ft. of public roads and Watercourses open to the public shall be lopped and scattered, chipped, or crushed, prior to April 1st of the year following its creation, so that no material generally remains more than thirty (30) inches above the ground.

As an exception to the above requirements after creation of Slash and debris, the RPF may propose and, with the concurrence of the Director's representative, delete those areas within 300 ft. not visible from roads or Watercourses when such requirements are not necessary to reduce fire hazards pursuant to § 917.2(b), to maintain soil fertility, to reduce erosion and to improve visual appearance.

(b) Burning: A determined effort shall be made to protect the surface organic horizon of the soil during the cause of any permitted Broadcast Burning operations.

(c) Snags: All snags within the WLPZ and within 100 feet (30.48 m) of meadow edges shall be left standing with the following exceptions:

(1) When felling is required for fire or safety reasons, as specified by the Rules or CAL OSHA regulations, or when necessary in sanitation-salvage operations.

(2) When a snag of commercial value is marked for felling by an RPF or supervised designee after an initial preharvest inspection and consultation with CDFW and the Timber Owner.

961.6 Hazard Reduction [C.C. Special Treatment Area]

There shall be no Broadcast Burning within Coastal Commission Special Treatment Areas. Piles surrounded by a firebreak may be burned, provided the burning is confined to the individual pile, and is in a location and conducted in a manner that will not damage the residual trees or reproduction. An exception may be approved by the Director when a prescribed burning plan is submitted as part of the plan which explains and justifies Broadcast Burning in the Coastal Commission Special Treatment Areas.

921.7 Watercourse and Lake Protection [C.C. Special Treatment]

Watercourse and lakeside vegetation shall be protected and remain standing to the degree necessary to protect scenic and natural qualities and protect the beneficial uses of water. In addition to the requirements of 14 CCR 916 through 916.9, Coastal Commission Special Treatment Area Watercourse and Lake Protection Zones adjacent to clearcuts or rehabilitation cutting shall be at least 150 feet on each side of Class I or II waters.

961.7 Watercourse and Lake Protection [Southern, Special Treatment Area]

Watercourse and lakeside vegetation shall be protected and remain standing to the degree necessary to protect scenic and natural qualities and protect the beneficial uses of water. In addition to the requirements of 14 CCR 956 through 956.8 the following standards shall apply in the Coastal Commission Special Treatment Areas. The Watercourse and Lake Protection Zone shall be 150 feet on each side of Class I Watercourses and lakes, and 100 feet on each side of Class II Watercourses.

921.8 Buffer Zones Within the Coastal Zone [Coastal Zone]

CALIFORNIA FOREST PRACTICE RULES

The following additional Rules shall apply to Buffer Zones within Coastal Scenic View Corridors and adjacent to publicly owned preserves and recreation areas as defined and/or designated by the Coastal Commission on July 5, 1977.

The Buffer Zone adjacent to designated Coastal highways shall be a 200 ft. (60.96 m) wide band running parallel to the first line of trees nearest the road on appropriate side(s) of the road as designated. In no place shall the Buffer Zone extend more than 350 feet (106.68 m) from the shoulder of the road. The Buffer Zone also shall include those forested areas within the Coastal Zone within 200 ft. (60.96 m) of a publicly owned preserves and recreation areas including national, state, regional, county, and municipal parks. Said distances shall be measured along the surface of the ground.

(a) The clear-cutting or rehabilitation silvicultural method is prohibited within the designated Buffer Zones, and a well distributed stand of trees shall be left within said Buffer Zones upon completion of Timber Operations, except under exceptional circumstances. Such exceptions shall be explained and justified in the plan and found in conformance by the Director when the proposed exceptions conform to the goals outlined in 14 CCR 921.

(b) Logging Roads, tractor roads, and skid trails and Landings shall be screened from direct view to the extent feasible by leaving trees and vegetation between the disturbed area and public areas where the disturbance would be visible to substantial numbers of viewers.

961.8 Buffer Zones Within the Coastal Zone [CZ, Southern]

A 200 feet (60.96 m) Buffer Zone shall be established adjacent to the boundaries of all publicly owned preserves and recreation areas within the Coastal Zone where the following restrictions shall apply:

(a) The use of the clear-cut silvicultural method is prohibited.

(b) A well distributed stand of trees shall be left within the Buffer Zone. The leave tree requirements of the commercial thinning or selection method shall be met or exceeded immediately following completion of Timber Operations.

(c) Roads, Landing, and cuts and fills shall be screened from direct view by leaving screen trees and other vegetation between the disturbed areas and public areas utilized by substantial numbers of viewers.

921.9 Alternatives [Coast, CZ]

The RPF may propose alternative to the requirements of this article on a site specific basis. The RPF must explain and justify the proposed alternative in the THP. Alternative measures stated in the plan shall be so written as to provide clear, enforceable standards for the guidance of the Timber Operator. The Director may approve such alternative provided the alternative practice will achieve equal protection for each of the goals of Section 921 and protection at least equal to that which would result from using measures stated in Section 921.1-921.8. The Director shall not accept for inclusion in a THP any alternative practice as described in this section where two or more agencies listed in 4582.6 of the PRC and 14 CCR 1037.3 have submitted written comments which lead to the Director's conclusion that the proposed alternative will not meet the intent of the Act and Rules and the agencies participated in the review of the plan, including any on-the-ground inspection.

CALIFORNIA FOREST PRACTICE RULES

Article 12. [Article 11. Northern] Logging Roads, Landings, and Logging Road Watercourse Crossings

923, 943, 963 Intent for Logging Roads, Landings, and Watercourse Crossings. [All Districts]

(a) All Logging Roads, Landings, and Logging Road Watercourse crossings in the logging area shall be planned, constructed, Reconstructed, used, maintained, removed, abandoned, and deactivated in a manner that:

- (1) Is consistent with long-term enhancement and maintenance of the forest resource.
- (2) Accommodates appropriate Yarding systems.
- (3) Is economically feasible.

(b) Such planning, construction, reconstruction, use, maintenance, removal, Abandonment, and deactivation shall occur in a manner that considers safety and avoids or substantially lessens significant adverse Impacts to, among other things:

- (1) Fish and wildlife habitat and listed species of fish and wildlife.
- (2) Water quality and the beneficial uses of water.
- (3) Soil resources.
- (4) Significant archeological and historical sites.
- (5) Air quality.
- (6) Visual resources.
- (7) Fire hazard.

(c) The RPF may propose exceptions to the Rules of this Article if explained and justified in the Plan and found by the Director not to result in a significant adverse Impact on the environment.

(d) Exceptions may also be provided through application of Fish and Game Code Section 1600 et seq. and shall be made an enforceable part of the Plan in accordance with 14 CCR §§ 1039, 1040, 1090.14, 1092.26, or 1092.27, 1094.23, or 1094.24, as appropriate.

(e) For watersheds with listed anadromous salmonids and for planning watersheds immediately upstream of, and contiguous to, any watershed with listed anadromous salmonids all Logging Roads, Landings, and Logging Road Watercourse crossings shall be planned, designed, constructed and Reconstructed, used, maintained, abandoned, deactivated, and removed in accordance with 14 CCR § 916.9, subsections (a) and (c) [936.9 (a) and (c), 956.9 (a) and (c)].

(f) The provisions of Article 12 [Article 11 for Northern District] that apply in watersheds with listed anadromous salmonids and in planning watersheds immediately upstream of, and contiguous to, any watershed with listed anadromous salmonids shall not apply to a plan that is subject to:

- (1) A valid incidental take permit issued by CDFW pursuant to Section 2081(b) of the Fish and Game Code that addresses anadromous salmonid protection; or
- (2) A federal incidental take statement or incidental take permit that addresses anadromous salmonid protection, for which a consistency determination has been made pursuant to Section 2080.1 of the Fish and Game Code; or
- (3) A valid natural community conservation plan that addresses anadromous salmonid protection approved by CDFW under Section 2835 of the Fish and Game Code; or
- (4) A valid Habitat Conservation Plan (HCP) that addresses anadromous salmonid protection, approved under Section 10 of the federal Endangered Species Act of 1973; or
- (5) Project revisions, guidelines, or take avoidance measures pursuant to a memorandum of understanding or a planning agreement entered into between the plan submitter and CDFW in preparation of obtaining a natural community conservation plan that addresses anadromous salmonid protection.

923.1, 943.1, 963.1 Planning for Logging Roads and Landings. [All Districts]

Logging Roads and Landings shall be planned and located within the context of a systematic layout pattern that considers 14 CCR § 923(b), uses existing Logging Roads and Landings where feasible and appropriate, and provides access for fire and resource protection activities.

(a) Logging Roads and Landings shall be planned and located to minimize the following:

- (1) Duplicative roads and total road mileage.
- (2) The number of Logging Road Watercourse crossings.

CALIFORNIA FOREST PRACTICE RULES

(3) Construction and reconstruction near Watercourses, lakes, marshes, and Wet Meadows, and Other Wet Areas.

(4) Construction and reconstruction across steep areas that lead without flattening to Class I, II, III, or IV Watercourses and lakes.

(5) Construction and reconstruction on unstable areas or in connected headwall swales.

(6) Construction and reconstruction near nesting sites of rare, threatened, or endangered bird species.

(7) Construction and reconstruction near populations of rare, threatened, or endangered plants.

(8) Ground disturbance and the size of cuts and fills.

(9) The potential for affecting surface hydrology, including, but not limited to, concentrating or diverting runoff or draining the Logging Road or Landing surface directly into a Watercourse or lake.

(10) Maintenance needs while being compatible with the Logging Road classification and long-term road usage.

(b) No Logging Roads or Landings shall be planned for construction (i) within 150 feet of the Class I Watercourse transition line, (ii) within 100 feet of the Class II Watercourse Transition Line on slopes greater than 30%, (iii) within Class I, II, III, or IV Watercourses or lakes, (iv) within a WLPZ, or (v) in marshes, or Wet Meadows and Other Wet Areas, except as follows:

(1) At existing Logging Road Watercourse crossings.

(2) At Logging Road Watercourse crossings to be constructed or Reconstructed that are approved as part of the Fish and Game Code process (F&GC § 1600 et seq.).

(3) At Logging Road Watercourse crossings of Class III Watercourses that are dry at the time of use.

(c) No Logging Roads or Landings shall be planned for reconstruction (i) within Class I, II, III, or IV Watercourses or lakes, (ii) within a WLPZ, or (iii) in marshes, or Wet Meadows and Other Wet Areas, except as follows:

(1) At existing Logging Road Watercourse crossings.

(2) At Logging Road Watercourse crossings to be constructed or Reconstructed that are approved as part of the Fish and Game Code process (F&GC § 1600 et seq.).

(3) At Logging Road Watercourse crossings of Class III Watercourses that are dry at the time of use.

(d) Logging Roads and Landings shall be planned and located to avoid unstable areas and connected headwall swales. The Director may approve an exception if those areas are unavoidable and site-specific measures to minimize slope instability due to Logging Road or Landing construction or reconstruction are described and justified in the plan.

(e) As part of the planning and use of Logging Roads, Landings, and Watercourse crossings in the logging area, the RPF or supervised designee shall: (i) locate and map significant existing and potential erosion sites and (ii) specify feasible treatments to mitigate significant adverse Impacts from the road or Landing.

(1) The RPF shall evaluate all Logging Roads and Landings in the logging area, including appurtenant roads, for evidence of significant existing and potential erosion sites.

(2) For significant existing and potential erosion sites identified pursuant to 14 CCR § 923.1[943.1, 963.1], subsection (e)(1), the RPF shall consider the following key factors as part of developing necessary treatments:

(A) Type of road (permanent, seasonal, or temporary road), road location, expected log truck haul routes, and traffic use (e.g., volume and season) of each road segment during the life of the plan.

(B) Age of road and the history of sediment delivery from existing roads.

(C) Beneficial uses of the Watercourse or lake and sensitive conditions potentially affected by the road including, but not limited to, Watercourse classification and presence of listed anadromous salmonids.

(D) The hillslope grade, road grade of crossing approaches and the gradient of the Stream channel.

(E) The erodibility of hillslope material exposed by the road.

(F) The length of hydrologic connectivity of a road segment, the physical properties of

CALIFORNIA FOREST PRACTICE RULES

the connected segment and the presence or absence of an effective sediment filter strip.

(G) Site-specific information regarding the condition of and location of all existing or potential sediment sources including, but not limited to: Watercourse crossings, road approaches, ditch relief culverts, road surfaces, road cuts, road fills, inboard ditches, through-cuts, and Landings.

(3) The RPF shall submit a list of the significant existing and potential erosion sites identified pursuant to 14 CCR § 923.1[943.1, 963.1], subsection (e)(1), which have feasible treatments with the plan. This list shall include the following information:

(A) A map showing the location(s) of significant existing and potential erosion site(s) with a unique identifier for each site.

(B) Brief description of present condition of the mapped significant existing or potential erosion site.

(C) Brief description of proposed treatments for the mapped significant existing or potential erosion site.

(D) Items (B) and (C) above can be provided in tabular form as part of the plan.

(4) The RPF shall disclose and map the significant existing and potential erosion sites identified pursuant to 14 CCR § 923.1[943.1, 963.1], subsection (e)(1), for which no feasible treatment measures exist.

(5) Where feasible treatments for significant existing or potential erosion sites are proposed, the RPF shall describe in the plan a logical order of treatment.

(f) When selecting feasible alternatives (see 14 CCR §§ 897 and 898) during the planning phase of Logging Roads and Landings, the RPF shall consider the location and planned use of Logging Roads and Landings and whether such Logging Roads and Landings will be abandoned or deactivated.

(g) In watersheds with listed anadromous salmonids and in planning watersheds immediately upstream of, and contiguous to, any watershed with listed anadromous salmonids, where Logging Road or Landing construction or reconstruction is proposed, the plan shall identify:

(1) How the proposed operations will fit into the systematic layout pattern.

(2) What, if any, offsetting mitigation measures, including, but not limited to, Abandonment of Logging Roads and Landings, are needed to minimize potential adverse Impacts to watersheds from the road system.

(h) In watersheds with listed anadromous salmonids, no Logging Roads or Landings shall be planned for construction or reconstruction in the CMZ or Core Zone of a Class I Watercourse except those listed in 14 CCR § 916.9(e)(1)(A)-(E) [936.9(e)(1)(A)-(E), 956.9(e)(1)(A)-(E)] or pursuant to 14 CCR § 916.9(v) [936.9(v), 956.9(v)], or within 150 feet of a Class I Watercourse transition line.

(i) In watersheds with listed anadromous salmonids within the Inner Zone A and B of flood prone areas of Class I Watercourses, the following Preferred Management Practices should be considered for inclusion in the plan by the RPF and by the Director:

(1) Constructed and Reconstructed Logging Roads and Landings should not be planned for location within these zones.

(2) When feasible, planned use of existing Logging Roads and Landings should be minimized in the flood prone area.

(3) Exceptions include the use of roads and Landings to accomplish actions to improve salmonid habitat conditions stated in 14 CCR § 916.9(f)(3)(E)1. [936.9(f)(3)(E)1., 956.9(f)(3)(E)1.].

923.2, 943.2, 963.2 Design and Location of Logging Roads and Landings. [All Districts]

Constructed and Reconstructed Logging Roads and Landings shall be designed and located in accordance with their proposed use, maintenance requirements, and the approved plan.

(a) All Logging Roads and Landings shall:

(1) Avoid or mitigate potential Impacts to public safety.

(2) Avoid unstable areas and connected headwall swales to the extent feasible and minimize activities that adversely affect them.

(3) Minimize the size of cuts and fills to the extent feasible.

(4) Be outsloped where feasible and drained with waterbreaks and/or rolling dips in conformance with other applicable Forest Practice Rules.

(5) Be hydrologically disconnected from Watercourses and lakes to the extent feasible to

CALIFORNIA FOREST PRACTICE RULES

minimize sediment delivery from road runoff to a Watercourse, and reduce the potential for hydrologic changes that alter the magnitude and frequency of runoff delivery to a Watercourse. Guidance on methods for hydrologic disconnection may be found in “Board of Forestry Technical Rule Addendum Number 5: Guidance on Hydrologic Disconnection, Road Drainage, Minimization of Diversion Potential, and High Risk Crossings” (1st Edition, revised 04/21/15), hereby incorporated by reference.

(6) Include adequate drainage structures and facilities necessary to avoid concentrating and diverting runoff, to minimize erosion of roadbeds, Landing surfaces, drainage ditches, sidecast and fills, to minimize the potential for soil erosion and sediment transport, and to prevent significant sediment discharge. Guidance on methods for conformance with this rule section may be found in “Board of Forestry Technical Rule Addendum Number 5: Guidance on Hydrologic Disconnection, Road Drainage, Minimization of Diversion Potential, and High Risk Crossings” (1st Edition, revised 04/21/15), hereby incorporated by reference.

(7) Avoid crossing, or locations on, 100 feet or more of lineal distance over any slopes greater than 65 percent or within 100 feet of the boundary of a WLPZ on slopes greater than 50 percent that drain toward the zoned Watercourse or lake. Where Logging Road or Landing construction or reconstruction is proposed in these areas, specific measures to minimize movement of soil and the discharge of concentrated surface runoff shall be incorporated in the plan. The Director may waive inclusion of such measures where the RPF can show that slope depressions, drainage ways, and other natural retention and detention features are sufficient to control overland transport of eroded material.

(b) The Director may require removal of deposits of excess material if the deposits are in a position to adversely affect the beneficial uses of water.

(c) Excess material excavated during Logging Road and Landing construction shall not be transported to locations where it may result in significant sediment discharge.

(d) In addition to the requirements of subsection (a) above, all Logging Roads to be constructed or to be Reconstructed shall:

(1) Be no wider than a single lane compatible with the largest type of equipment specified for use on the Logging Road, with adequate turnouts provided as required for safety, except where wider road dimensions are required by existing contracts with a federal agency.

(2) Avoid grades greater than 20% or grades greater than 15% that extend greater than 500 continuous feet. Exceptions may be approved where there is no other feasible access for harvesting of timber or where use of a gradient greater than 20% will serve to reduce soil disturbance.

(e) In addition to the requirements of subsection (a) above, all Landings to be constructed or to be Reconstructed shall:

(1) Be consistent with the Yarding and loading system to be used.

(2) Be no larger than one-half acre.

(3) Avoid construction on slopes greater than 40 percent where the Landing will exceed one-quarter acre in size.

923.3, 943.3, 963.3. Mapping and Identification of Logging Roads and Landings. [All Districts]

The following mapping and identification standards shall apply to Logging Roads and Landings:

(a) For Logging Road- and Landing-related mapping requirements refer to 14 CCR §§ 1034(x)(4)(A)-(E) and (5)(A)-(G), 1090.5(w)(4)(A)-(L) and (5)-(6), 1090.5(gg), 1090.7(n)(4)-(7), and 1092.09(1)(5)(A)(1.-5.) and (6)(A)-(G), 1094.6(e)(4)-(5), (11) and (15) - (16) and 1094.8(u)(4)-(7) and (13)-(14).

(b) The RPF shall identify in the field, for use by the LTO, all Logging Roads and Landings to be constructed or to be Reconstructed:

(1) Across slopes greater than sixty-five (65) percent for one hundred (100) lineal feet or more.

(2) Across slopes greater than fifty (50) percent for one hundred (100) lineal feet or more within one hundred (100) feet of the boundary of a WLPZ that drains toward the zoned Watercourse or lake.

(c) The location of all Logging Roads to be constructed or to be Reconstructed shall be flagged or otherwise identified on the ground prior to the pre-harvest inspection. Exceptions may be explained and justified in the plan and agreed to by the Director if flagging is unnecessary as a substantial aid to examining: (1) compatibility between Logging Road location and Yarding and silvicultural systems, or (2) possible significant adverse effects of Logging Road location on the factors listed under 14 CCR § 923(b) [943(b),

CALIFORNIA FOREST PRACTICE RULES

963(b)].

923.4, 943.4, 963.4. Construction and Reconstruction of Logging Roads and Landings. [All Districts]

Logging Roads and Landings shall be constructed or Reconstructed in accordance with the approved Plan and the following requirements. If a change in designation of Logging Road classification is made after the Plan is approved, the change shall be reported in accordance with 14 CCR §§ 1039, 1040, 1090.14, 1092.26, 092.27, 1094.23 or 1094.24 as appropriate.

(a) Logging Roads and Landings shall be hydrologically disconnected from Watercourses and lakes to the extent feasible to minimize sediment delivery from road runoff to a Watercourse, and reduce the potential for hydrologic changes that alter the magnitude and frequency of runoff delivery to a Watercourse. Guidance on methods for hydrologic disconnection may be found in “Board of Forestry Technical Rule Addendum Number 5: Guidance on Hydrologic Disconnection, Road Drainage, Minimization of Diversion Potential, and High Risk Crossings” (1st Edition, revised 04/21/15), hereby incorporated by reference.

(b) No Logging Roads or Landings shall be constructed (i) within 150 feet of the Class I Watercourse transition line, (ii) within 100 feet of the Class II Watercourse Transition Line on slopes greater than 30%, (iii) within Class I, II, III, or IV Watercourses or lakes, (iv) within a WLPZ, or (v) in marshes, Wet Meadows, and Other Wet Areas, except as follows:

- (1) At existing Logging Road Watercourse crossings.
- (2) At Logging Road Watercourse crossings to be constructed or Reconstructed that are approved as part of the Fish and Game Code process (F&GC § 1600 et seq.)
- (3) At Logging Road Watercourse crossings of Class III Watercourses that are dry at the time of use.

(c) No Logging Roads or Landings shall be Reconstructed (i) within Class I, II, III, or IV Watercourses or lakes, (ii) within a WLPZ, or (iii) in marshes, and Wet Meadows and Other Wet Areas, except as follows:

- (1) At existing Logging Road Watercourse crossings.
- (2) At Logging Road Watercourse crossings to be constructed or Reconstructed that are approved as part of the Fish and Game Code process (F&GC § 1600 et seq.)
- (3) At Logging Road Watercourse crossings of Class III Watercourses that are dry at the time of use.

(d) Logging Roads and Landings shall not be constructed or Reconstructed across unstable areas or connected headwall swales except as specified in the Plan.

(e) Logging Roads and Landings shall not be constructed with overhanging banks.

(f) Any tree over 12 inches d.b.h. with more than 25 percent of the root surface exposed by Logging Road or Landing construction shall be felled concurrently with the Timber Operations.

(g) On slopes greater than 40 percent, the organic layer of the soil shall be removed prior to fill placement.

(h) Waste organic material, such as uprooted stumps, cull logs, accumulations of limbs and branches, and unmerchantable trees, shall not be buried in Logging Road or Landing fills. Wood debris or cull logs and chunks may be placed and stabilized at the toe of fill to restrain excavated soil from moving downslope.

(i) Slash and other debris from road construction shall not be bunched against residual trees, which are required for silvicultural or wildlife purposes, nor shall it be placed in locations where it could be discharged into Class I or II Watercourses or lakes.

(j) Where constructed fills will exceed three feet in vertical thickness, fill slopes shall be inclined no greater than 65 percent.

(k) Logging Roads or Landings shall not be constructed or Reconstructed under saturated soil conditions that may produce significant sediment discharge, except that construction may occur on isolated wet spots arising from localized ground water such as springs, provided measures are taken to prevent significant sediment discharge.

(l) Construction or reconstruction of Logging Roads or Landings shall not take place during the winter period unless the approved plan incorporates a complete winter period operating plan pursuant to 14 CCR § 914.7 [934.7, 954.7] that specifically addresses such Logging Road or Landing construction or reconstruction.

(m) On slopes greater than 50 percent for greater than 100 lineal feet, fills greater than four feet in vertical height at the outside shoulder of the Logging Road or Landing shall be:

CALIFORNIA FOREST PRACTICE RULES

(1) Constructed on a bench that is excavated at the proposed toe of the fill and is wide enough to compact the first lift.

(2) Compacted in approximately one-foot lifts from the toe to the finished grade or retained by an engineered structure.

(n) Logging Roads and Landings approved for construction or reconstruction across 100 feet or more of lineal distance on any slope greater than 65 percent or within 100 feet of the boundary of a WLPZ on slopes greater than 50 percent that drain toward the zoned Watercourse or lake shall be constructed to the specific construction techniques or measures as described in the plan.

(o) Fills shall not be constructed on slopes greater than 65 percent.

(p) On slopes greater than 65 percent, sidecast from Logging Road and Landing construction shall be minimized to the degree feasible.

(q) Excess material transported from Logging Road or Landing construction or reconstruction shall be deposited and stabilized in a manner and in areas that avoid potential adverse Impacts to locations that could deliver significant sediment discharge.

(r) In watersheds with listed anadromous salmonids, no Logging Roads or Landings shall be constructed or Reconstructed within the CMZ or Core Zone of a Class I Watercourse except for those listed in 14 CCR § 916.9 [936.9, 956.9], subsections (e)(1)(A)-(F), or pursuant to 14 CCR § 916.9 [936.9, 956.9], subsection (v).

(s) In watersheds with listed anadromous salmonids and in planning watersheds immediately upstream of, and contiguous to, any watershed with listed anadromous salmonids, the following shall apply:

(1) On slopes greater than 50 percent that have access to a Watercourse or lake:

(A) Specific provisions for the protection of salmonid habitat shall be identified and described for all Logging Road construction.

(B) Where cutbank stability is not an issue, Logging Roads may be constructed as a full-benched cut (no fill). Spoils not utilized in Logging Road construction shall be disposed of in stable areas with less than 30 percent slope outside of any WLPZ, EEZ, or ELZ designated for Watercourse or lake protection. The Director, with concurrence from other responsible agencies, may waive inclusion of these measures where the RPF can show that slope depressions and other natural retention and detention features are sufficient to control overland transport of eroded material.

(C) Logging Roads may be constructed with balanced cuts and fills:

1. If properly engineered, or,

2. If fills are removed and the slopes recontoured prior to the winter period.

(2) During the extended wet weather period, no Timber Operations shall take place unless the approved plan incorporates a complete winter period operating plan pursuant to 14 CCR § 914.7(b) [934.7(b), 954.7(b)]. The winter period operating plan shall specifically address, where applicable, proposed Logging Road and Landing construction, and reconstruction.

923.5, 943.5, 963.5. Erosion Control for Logging Roads and Landings. [All Districts]

The following erosion control standards shall apply to Logging Roads and Landings:

(a) All Logging Road and Landing surfaces shall be adequately drained through the use of Logging Road and Landing surface shaping in combination with the installation of drainage structures or facilities and shall be hydrologically disconnected from Watercourses and lakes to the extent feasible. Guidance on methods for hydrologic disconnection may be found in “Board of Forestry Technical Rule Addendum Number 5: Guidance on Hydrologic Disconnection, Road Drainage, Minimization of Diversion Potential, and High Risk Crossings” (1st Edition, revised 04/21/15), hereby incorporated by reference.

(b) Drainage facilities and structures shall be installed along all Logging Roads and all Landings that are used for Timber Operations in sufficient number to minimize soil erosion and sediment transport and to prevent significant sediment discharge.

(c) Ditch drains, associated necessary protective structures, and other features associated with the ditch drain shall:

(1) Be adequately sized to convey runoff.

(2) Minimize erosion of Logging Road and Landing surfaces.

(3) Avoid discharge onto unprotected fill.

CALIFORNIA FOREST PRACTICE RULES

- (4)** Discharge to erosion resistant material.
- (5)** Minimize potential adverse Impacts to slope stability.

(d) Waterbreaks and rolling dips installed across Logging Roads and Landings shall be of sufficient size and number and be located to avoid collecting and discharging concentrated runoff onto fills, erodible soils, unstable areas, and connected headwall swales.

(e) Where Logging Roads or Landings do not have permanent and adequate drainage, and where waterbreaks are to be used to control surface runoff, the waterbreaks shall be cut diagonally a minimum of six inches into the firm roadbed and shall have a continuous firm embankment of at least six inches in height immediately adjacent to the lower edge of the waterbreak cut. On Logging Roads that have firmly compacted surfaces, waterbreaks may be installed by hand methods and need not provide the additional six-inch embankment provided the waterbreak ditch is constructed so that it is at least six inches deep and six inches wide on the bottom and provided there is ample evidence based on slope, material, amount of rainfall, and period of use that the waterbreaks so constructed will be effective in diverting water flow from the Logging Road surface without the embankment.

(f) Distances between waterbreaks shall not exceed the following standards and consider erosion hazard rating and road gradient:

MAXIMUM DISTANCE BETWEEN WATERBREAKS			
Estimated Hazard Rating	Logging Road		Gradient in Percent
	10 or less	11-25	>25
	Feet	Feet	Feet
Extreme	100	75	50
High	150	100	75
Moderate	200	150	100
Low	300	200	150

(g) Where outsloping and rolling dips are used to control surface runoff, the dip in the Logging Road grade shall be sufficient to capture runoff from the Logging Road surface. The steepness of cross-slope gradient in conjunction with the Logging Road or Landing gradient and the estimated soil erosion hazard rating shall be used to determine the rolling dip spacing in order to minimize soil erosion and sediment transport and to prevent significant sediment discharge. Guidance on rolling dip spacing may be found in “Board of Forestry Technical Rule Addendum Number 5: Guidance on Hydrologic Disconnection, Road Drainage, Minimization of Diversion Potential, and High Risk Crossings” (1st Edition, revised 04/21/15), hereby incorporated by reference.

(h) Drainage facilities and structures shall discharge into vegetation, woody debris, or rock wherever possible. Where erosion-resistant material is not present, Slash, rock, or other energy dissipating material shall be installed below the drainage facility or drainage structure outlet as necessary to minimize soil erosion and sediment transport and to prevent significant sediment discharge. Guidance on energy dissipaters for drainage structures may be found in “Board of Forestry Technical Rule Addendum Number 5: Guidance on Hydrologic Disconnection, Road Drainage, Minimization of Diversion Potential, and High Risk Crossings” (1st Edition, revised 04/21/15), hereby incorporated by reference.

(i) Where Logging Road and Landing surfaces, road approaches, inside ditches and drainage structures cannot be hydrologically disconnected, and where there is existing or the potential for significant sediment discharge, necessary and feasible treatments to prevent the discharge shall be described in the plan.

(j) All Logging Roads and Landings used for Timber Operations shall have adequate drainage upon completion of use for the year or by October 15, whichever is earlier. An exception is that drainage facilities and drainage structures do not need to be constructed on Logging Roads and Landings in use during the extended wet weather period provided that all such drainage facilities and drainage structures are installed prior to the start of rain that generates overland flow.

(k) Where Logging Road or Landing construction or reconstruction takes place during the extended wet weather period, drainage facilities and drainage structures shall be installed concurrent with construction or reconstruction operations.

CALIFORNIA FOREST PRACTICE RULES

(l) Bare soil on Logging Road or Landing cuts, fills, transported spoils, or sidecast that is created or exposed by Timber Operations shall be stabilized to the extent necessary to minimize soil erosion and sediment transport and to prevent significant sediment discharge. Sites to be stabilized include, but are not limited to:

- (1)** Sidecast or fill exceeding 20 feet in slope distance from the outside edge of a Logging Road or a Landing that has access to a Watercourse or lake.
- (2)** Cut and fills associated with approaches to Logging Road Watercourse crossings of Class I or II waters or Class III waters where an ELZ, EEZ, or a WLPZ is required.
- (3)** Bare areas exceeding 800 continuous square feet within a WLPZ.

(m) Soil stabilization measures shall be described in the plan pursuant to 14 CCR § 923.5(l) [943.5(l), 963.5(l)], and may include, but are not limited to, removal, armoring with rip-rap, replanting, mulching, seeding, installing commercial erosion control devices to manufacturer's specifications, or chemical stabilizers.

(n) Where the natural ability of ground cover within a WLPZ is inadequate to protect the beneficial uses of water by minimizing soil erosion or by filtering sediments, the plan shall specify protection measures to retain and improve the natural ability of the ground cover to filter sediment and minimize soil erosion.

(o) Soil stabilization treatments shall be in place upon completion of operations for the year of use or prior to the extended wet weather period, whichever comes first. An exception is that bare areas created during the extended wet weather period shall be treated prior to the start of rain that generates overland flow, or within 10 days of the creation of the bare area(s), whichever is sooner, or as agreed to by the Director.

(p) Overhanging or unstable concentrations of Slash, woody debris or soil along the downslope edge or face of Landings shall be removed or stabilized when it is located on slopes greater than 65 percent, within 100 feet of the boundary of a WLPZ on slopes greater than 50 percent that drain toward the zoned Watercourse or lake, or when it may result in significant sediment discharge. Removed materials shall not be placed at disposal sites that could result in a significant sediment discharge.

(q) In watersheds with listed anadromous salmonids and in planning watersheds immediately upstream of, and contiguous to, any watershed with listed anadromous salmonids, the following shall apply:

- (1)** Constructed and Reconstructed Logging Roads shall be outslowed where feasible and drained with waterbreaks or rolling dips.
- (2)** In addition to the provisions listed under 14 CCR § 923.2(d)(2) [943.2(d)(2), 963.2(d)(2)], all permanent and seasonal Logging Roads with a grade of 15 percent or greater that extend 500 continuous feet or more shall have specific erosion control measures stated in the plan.
- (3)** Within the WLPZ, and within any ELZ or EEZ designated for Watercourse or lake protection, treatments to stabilize soils, minimize soil erosion, and prevent significant sediment discharge shall be described in the plan as follows:

(A) In addition to the requirements of subsections (l)-(o), soil stabilization is required for the following areas:

1. Areas exceeding 100 continuous square feet where Timber Operations have exposed bare soil, and
2. Disturbed Logging Road and Landing cut banks and fills, and
3. Any other area of disturbed soil that threatens to cause significant sediment discharge.

(B) Where straw mulch is used, the minimum straw coverage shall be 90 percent, and any treated area that has been reused or has less than 90 percent surface cover shall be treated again by the end of Timber Operations.

(C) Where Slash mulch is applied, a minimum of 75% of the area shall be covered by Slash in contact with the ground.

(D) For areas disturbed outside of the extended wet weather period, treatment shall be completed prior to the start of any rain that causes overland flow across or along the disturbed surface that could result in significant sediment discharge.

(E) For areas disturbed during the extended wet weather period, treatment shall be completed prior to any day for which a chance of rain of 30 percent or greater is forecast by the National Weather Service or within 10 days of disturbance, whichever is earlier.

CALIFORNIA FOREST PRACTICE RULES

(F) Where the natural ability of ground cover is inadequate to protect the beneficial uses of water by minimizing soil erosion or by filtering sediments within any ELZ or EEZ designated for Watercourse or lake protection, the plan shall specify protection measures to retain and improve the natural ability of the ground cover to filter sediment and minimize soil erosion.

923.6, 943.6, 963.6. Use of Logging Roads and Landings. [All Districts]

The following use standards shall apply to Logging Roads and Landings:

- (a)** Logging Roads and Landings shall be used in a manner that is consistent with their design and construction specifications.
- (b)** Logging Roads and Landings shall not be used during any time of the year when operations may result in significant sediment discharge to Watercourse or lakes, except in emergencies to protect the road, to reduce erosion, to protect water quality, or in response to public safety needs.
- (c)** During the extended wet weather period, log hauling or other heavy equipment uses shall be limited to Logging Roads and Landings that exhibit a stable operating surface in conformance with (b) above. Routine use of Logging Roads and Landings shall not occur when equipment cannot operate under its own power.
- (d)** When burning permits are required pursuant to PRC § 4423, Logging Roads and Landings that are in use shall be kept in passable condition for fire trucks.
- (e)** Roadside berms that impede Logging Road drainage, concentrate Logging Road surface flow, or lead to hydrologic connection shall be removed or breached before the beginning of the winter period, with the exception of berms needed for erosion control.
- (f)** Temporary roads shall be blocked or otherwise closed to standard production four-wheel drive highway vehicles prior to the winter period, or upon completion of use as specified in an approved winter period operating plan pursuant to 14 CCR § 914.7(b) [934.7(b), 954.7(b)].
- (g)** Logging Roads and Landings used for log hauling or other heavy equipment uses during the winter period shall occur on a stable operating surface and, where necessary, be surfaced with rock to a depth and quantity sufficient to maintain such a surface. Use is prohibited on roads that are not hydrologically disconnected and exhibit saturated soil conditions. Exceptions may be proposed by the RPF when locations are disclosed and justified in the THP, consistent with 14 CCR § 923(c). Exceptions must be approved by the Director.
- (h)** In watersheds with listed anadromous salmonids and in planning watersheds immediately upstream of, and contiguous to, any watershed with listed anadromous salmonids, the following shall apply:
 - (1)** Existing Logging Roads or Landings shall not be used within the CMZ of a Class I Watercourse except as listed in 14 CCR § 916.9 [936.9, 956.9] subsection (e)(1)(A)-(F) or pursuant to 14 CCR § 916.9(v) [936.9(v), 956.9(v)].
 - (2)** When feasible, minimize use of existing Logging Roads and Landings located within Inner Zones A and B of flood prone areas. Exceptions include the use of roads and Landings to accomplish actions to improve salmonid habitat conditions stated in 14 CCR § 916.9(f)(3)(E)1. [936.9(f)(3)(E)1., 956.9(f)(3)(E)1.].
 - (3)** Log hauling on Logging Roads and Landings shall be limited to those which are hydrologically disconnected from Watercourses to the extent feasible, and exhibit a stable operating surface in conformance with (b) above. Exceptions may be proposed by the RPF when locations are disclosed and justified in the THP, consistent with 14 CCR § 923(c). Exceptions must be approved by the Director.
 - (4)** Concurrent with use for log hauling, all road approaches to Logging Road Watercourse crossings shall be treated for erosion control as needed to minimize soil erosion and sediment transport and to prevent significant sediment discharge to Watercourses or lakes.
 - (5)** Concurrent with use for log hauling, all traveled surfaces of Logging Roads in a WLPZ, and ELZ or EEZ designated for Watercourse or lake protection, shall be treated for erosion control as needed to minimize soil erosion and sediment transport and to prevent significant sediment discharge to Watercourses or lakes.
 - (6)** No Timber Operations shall take place during the extended wet weather period unless the approved plan incorporates a complete winter period operating plan pursuant to 14 CCR § 914.7(b) [934.7(b), 954.7(b)] that specifically addresses, where applicable, proposed Logging Road or Landing use.

CALIFORNIA FOREST PRACTICE RULES

923.7, 943.7, 963.7. Maintenance and Monitoring of Logging Roads and Landings. [All Districts]

The following maintenance and monitoring standards shall apply to Logging Roads and Landings:

(a) Logging Road and Landing surfaces shall be monitored and maintained during Timber Operations and throughout the prescribed maintenance period to ensure hydrologic disconnection from Watercourses and lakes to the extent feasible, minimize soil erosion and sediment transport, and to prevent significant sediment discharge.

(b) Logging Roads that are used in connection with stocking activities shall be maintained throughout such use, even if this extends beyond the prescribed maintenance period.

(c) During Timber Operations, road running surfaces in the logging area shall be treated as necessary to prevent excessive loss of road surface materials by methods including, but not limited to, rocking, watering, paving, chemically treating, or installing commercial erosion control devices to manufacturer's specifications.

(d) Grading of Logging Roads or Landings to obtain a drier running surface more than one time before reincorporation of any resulting berms back into the road surface is prohibited.

(e) Drainage facilities and drainage structures, including associated necessary protective structures, shall be maintained to allow free flow of water, and minimize soil erosion and slope instability. Drainage facilities and structures shall be repaired, replaced, or installed as needed to protect the quality and beneficial uses of water.

(f) Soil stabilization treatments on Logging Road or Landing cuts, fills, and sidecast shall be maintained as needed to reduce the potential for slope instability, minimize soil erosion and sediment transport, and to prevent significant sediment discharge.

(g) Heavy equipment shall not be used in a WLPZ for maintenance during wet weather, except in emergencies to protect the road, to reduce erosion, to protect water quality, or in response to public safety needs.

(h) Where there is evidence of significant sediment discharge along a Logging Road or Landing used for Timber Operations, additional measures shall be implemented to minimize soil erosion and sediment transport, and to prevent significant sediment discharge.

(i) The prescribed maintenance period for erosion controls on Logging Roads and associated Landings and drainage structures, including appurtenant, abandoned, and deactivated Logging Roads and Landings, shall be at least one year. The Director may prescribe a maintenance period extending up to three years in accordance with 14 CCR § 1050.

(j) In watersheds with listed anadromous salmonids and in planning watersheds immediately upstream of, and contiguous to, any watershed with listed anadromous salmonids, the prescribed maintenance period for deactivated or abandoned roads shall be one year unless otherwise prescribed by the Director pursuant to 14 CCR § 1050. The prescribed maintenance period for Logging Roads and associated Landings, including appurtenant roads, shall be three years.

(k) All Logging Roads, including abandoned, deactivated, and appurtenant roads, Landings, and associated drainage structures used for Timber Operations shall be monitored as needed to comply with 14 CCR § 1050. Monitoring inspections shall be conducted, when access is feasible during the prescribed maintenance period, a sufficient number of times during the extended wet weather period, particularly after large winter storm events and at least once annually, to evaluate the function of drainage facilities and structures. The Department shall also conduct monitoring inspections at least once during the prescribed maintenance period to assess Logging Road and Landing conditions.

(1) Inspections shall include checking drainage facilities and structures for evidence of downcutting, plugging, overtopping, loss of function, and sediment delivery to Class I, II, or III Watercourses and lakes. If evidence of sediment delivery or potential sediment delivery is present, and the implementation of feasible corrective measures could reduce the potential for significant sediment discharge, such additional measures shall be implemented when feasible.

(2) Inspections conducted pursuant to California Regional Water Quality Control Board requirements may be used to satisfy the inspection requirements of this section.

(l) In watersheds with listed anadromous salmonids, water drafting for Timber Operations shall:

(1) Comply with Fish and Game Code Section 1600, et seq. Timber Operations conducted under a Fish and Game Code Section 1600 Master Agreement for Timber Operations that includes water

CALIFORNIA FOREST PRACTICE RULES

drafting may provide proof of such coverage for compliance with 14 CCR § 923.7(l).

- (2) Describe the water drafting site conditions and proposed water drafting activity in the plan, including:
- (A) A general description of the conditions and proposed water drafting;
 - (B) The Watercourse classification;
 - (C) The drafting parameters including the months the site is proposed for use; estimated total volume needed per day; estimated maximum instantaneous drafting rate and filling time; and disclosure of other water drafting activities in the same watershed;
 - (D) The estimated drainage area (acres) above the point of diversion;
 - (E) The estimated unimpeded streamflow, pumping rate, and drafting duration;
 - (F) A discussion of the effects on aquatic habitat downstream from the drafting site(s) of single pumping operations, or multiple pumping operations at the same location, and at other locations in the same watershed;
 - (G) A discussion of proposed alternatives and measures to prevent adverse effects to fish and wildlife resources, such as reducing hose diameter; using gravity-fed tanks instead of truck pumping; reducing the instantaneous or daily intake at one location; describing allowances for recharge time; using other dust palliatives; and drafting water at alternative sites; and
 - (H) The methods that will be used to measure source streamflow prior to the water drafting operation and the conditions that will trigger streamflow to be measured during the operation.
- (3) All water drafting for Timber Operations are subject to each requirement below unless the Department of Fish and Wildlife modifies the requirement in the Lake or Streambed Alteration agreement that authorized the drafting operation, or unless otherwise specified below:
- (A) All intakes shall be screened to prevent impingement of juvenile fish against the screen. The following requirements apply to screens and water drafting on Class I waters:
 - 1. Openings in perforated plate or woven wire mesh screens shall not exceed 3/32 inches (2.38 millimeters). Slot openings in wedge wire screens shall not exceed 1/16 inches (1.75 millimeters).
 - 2. The screen surface shall have at least 2.5 square feet of openings submerged in water.
 - 3. The drafting operator shall regularly inspect, clean, and maintain screens to ensure proper operation whenever water is drafted.
 - 4. The approach velocity (water moving through the screen) shall not exceed 0.3 feet/second.
 - 5. The diversion rate shall not exceed 350 gallons per minute.
 - (B) Approaches and associated drainage features to drafting locations within a WLPZ or Channel Zone shall be surfaced with rock or other suitable material to minimize generation of sediment.
 - (C) Barriers to sediment transport, such as straw wattles, logs, straw bales or sediment fences, shall be installed outside the normal high water mark to prevent sediment delivery to the Watercourse and limit truck encroachment.
 - (D) Water drafting trucks parked on streambeds, floodplains, or within a WLPZ shall use drip pans or other devices such as adsorbent or absorbent blankets, sheet barriers or other materials as needed to prevent soil and water contamination from motor oil or hydraulic fluid leaks.
 - (E) Bypass flows for Class I Watercourses shall be provided in volume sufficient to avoid dewatering the Watercourse and maintain aquatic life downstream, and shall conform to the following standard:
 - 1. Bypass flows in the source Stream during drafting shall be at least 2 cubic feet per second.
 - 2. Diversion rate shall not exceed 10 percent of the surface flow.
 - 3. Pool volume reduction shall not exceed 10 percent.
 - (F) The drafting operator shall keep a log that records, for each time water is drafted: the date, total pumping time, pump rate, starting time, ending time, and volume diverted. Logs shall be filed with the Department of Forestry and Fire Protection at the end of seasonal operations and maintained with the plan record. This requirement may be modified in the approved plan that covers the water drafting, but

CALIFORNIA FOREST PRACTICE RULES

only with concurrence from the Department of Fish and Wildlife.

(G) Before commencing any water drafting operation, the RPF and the drafting operator shall conduct a pre-operations field review to discuss the water drafting measures in the plan and/or Lake or Streambed Alteration Agreement.

923.8, 943.8, 963.8. Abandonment and Deactivation of Logging Roads and Landings. [All Districts]

All Logging Roads and Landings that are proposed to be removed from the Permanent Road Network shall be abandoned. All temporary Logging Roads and Landings that are to remain a part of the Permanent Road Network shall be deactivated annually prior to the winter period or upon completion of Timber Operations as specified in an approved winter period operating plan pursuant to 14 CCR § 914.7(b) [934.7(b), 954.7(b)]. Other Logging Roads and Landings proposed to be deactivated shall comply with the standards specified in this section. Where Abandonment or deactivation is required or proposed, specific measures to prevent significant sediment discharge that apply the following general requirements shall be described in the plan:

(a) All abandoned and deactivated Logging Roads and Landings shall be left in a condition that provides for long-term, maintenance-free function of drainage and erosion controls.

(b) Soil exposed by Abandonment or deactivation operations shall be removed or stabilized as needed to minimize soil erosion and sediment transport.

(c) Logging Road Watercourse crossings, other drainage structures, and associated fills shall be removed and stabilized in accordance with 14 CCR § 923.9 [943.9, 963.9], subsections (p)(1)-(4).

(d) Logging Roads to be abandoned or deactivated shall be blocked prior to the winter period, or upon completion of Timber Operations as specified in an approved winter period operating plan pursuant to 14 CCR § 914.7(b) [934.7(b), 954.7(b)], so that standard production four wheel-drive highway vehicles cannot pass the point of closure at the time of Abandonment or deactivation. If the Logging Road is to be abandoned, then the blockage design shall be described in the plan.

923.9, 943.9, 963.9. Watercourse Crossings. [All Districts]

Watercourse crossing drainage structures on Logging Roads shall be planned, constructed, Reconstructed, and maintained or removed according to the standards provided in this rule section.

(a) The planning for and use of Logging Road Watercourse crossings shall include the evaluation and documentation of significant existing and potential erosion sites consistent with 14 CCR § 923.1(e) [943.1(e), 963.1(e)].

(b) The number of crossings shall be kept to a feasible minimum. Existing Logging Road Watercourse crossing locations shall be utilized where feasible and appropriate.

(c) All new drainage structures and facilities on Watercourses that support fish or listed aquatic species shall allow for unrestricted passage of all life stages that may be present, and allow for the natural movement of bedload to form a continuous bed through the crossing. Such structures and facilities shall be fully described in the plan in sufficient clarity and detail to allow evaluation by the review team and the public, provide direction to the LTO for implementation, and provide enforceable standards for the inspector.

(d) In watersheds with listed anadromous salmonids, a description of all existing permanent Class I Watercourse crossings shall be provided, where fish are always or seasonally present or where fish passage is restorable. Where it is determined that current crossing conditions may be adversely affecting fish passage at any life stage, the RPF shall disclose such conditions in the plan and propose measures, if feasible, to address these conditions subject to the Director's review and determination.

(e) The location of all new permanent constructed and Reconstructed, and temporary Logging Road Watercourse crossings, including those crossings to be abandoned or deactivated, shall be shown on a map. If the structure is a culvert intended for permanent use, the minimum diameter of the culvert and the method(s) used to determine the culvert diameter shall be specified in the plan.

(1) The location of all Logging Road Watercourse crossings to be constructed or Reconstructed shall be flagged or otherwise identified on the ground prior to the pre-harvest inspection, if necessary, or prior to Logging Road Watercourse crossing construction or reconstruction. Exceptions may be explained and justified in the plan and agreed to by the Director if flagging is unnecessary as a substantial aid to examining possible significant adverse effects of the crossing location on the factors listed under 14 CCR § 923(b) [943(b), 963(b)].

CALIFORNIA FOREST PRACTICE RULES

(f) All permanent Watercourse crossings that are constructed or Reconstructed shall accommodate the estimated 100-year flood flow, including debris and sediment loads.

(g) All culverts used for new and replacement Logging Road Watercourse crossings shall be installed at or as close as practical and feasible to the natural Watercourse grade. Culverts shall be installed in alignment with the Watercourse channel to the extent feasible, and of the appropriate length to prevent fill erosion.

(h) Logging Road Watercourse crossings shall not discharge water onto erodible fill or other erodible material without the installation of energy dissipaters and other necessary protective structures.

(i) Fills for constructed and Reconstructed Logging Road Watercourse crossings shall be thoroughly compacted in approximately one-foot lifts during installation. The face of crossing fills shall be no greater than 65 percent (1.5:1, horizontal to vertical). Excavated material and cut banks resulting from construction or reconstruction which has access to a Watercourse shall be sloped back from the channel to prevent slumping, to minimize soil erosion, and to prevent significant sediment discharge.

(j) Critical dips shall be incorporated into the construction or reconstruction of Logging Road Watercourse crossings utilizing culverts, except where diversion of overflow is addressed by other methods stated in the plan.

(k) Watercourse crossings and associated fills and approaches shall be constructed and maintained to prevent diversion of Stream overflow down the road, and to minimize fill erosion should the drainage structure become obstructed. Methods to mitigate or address diversion of Stream overflow at Logging Road Watercourse crossings shall be stated in the plan.

(l) Any necessary protective structures associated with Logging Road Watercourse crossings such as wing walls, rock armored headwalls, and downspouts shall be adequately sized to transmit runoff, minimize erosion of crossing fills, and prevent significant sediment discharge. Rock used to stabilize the outlets of crossings shall be adequately sized to resist mobilization, with the range of required rock dimensions described in the plan.

(m) The following drainage standards shall apply to Logging Road Watercourse crossings:

(1) Adequate surface drainage at Logging Road Watercourse crossings shall be provided through the use of Logging Road surface shaping in combination with the installation of drainage facilities, ditch drains, or other necessary protective structures to hydrologically disconnect the road from the crossing to the extent feasible.

(2) Consistent with 14 CCR § 923.5(a)-(i) [943.5(a)-(i), 963.5(a)-(i)], drainage facilities and ditch drains shall be installed adjacent to Logging Road Watercourse crossings, as needed, to hydrologically disconnect to the extent feasible the Logging Road approach from the crossing, to minimize soil erosion and sediment transport, and to prevent significant sediment discharge during and upon completion of Timber Operations. Guidance on hydrologic disconnection may be found in “Board of Forestry Technical Rule Addendum Number 5: Guidance on Hydrologic Disconnection, Road Drainage, Minimization of Diversion Potential, and High Risk Crossings” (1st Edition, revised 04/21/15), hereby incorporated by reference.

(3) Drainage structures and facilities installed adjacent to Logging Road Watercourse crossings shall be located to avoid discharging concentrated runoff onto fills, erodible soils, unstable areas, and connected headwall swales to the extent feasible.

(n) Where a significant volume of sediment is stored upstream from a Logging Road Watercourse crossing that is proposed to be Reconstructed or removed, the stored sediment shall be removed or stabilized, to the extent feasible, as described in the plan and in conformance with the conditions of required CDFW 1600 agreements, where applicable.

(o) Where crossing fills over culverts are large, or where Logging Road Watercourse crossing drainage structures and erosion control features historically have a high failure rate, such drainage structures and erosion control features shall be oversized, designed for low maintenance, reinforced, or removed before the completion of Timber Operations or as specified in the Plan. Guidance on reducing the potential for failure at high risk Watercourse crossings may be found in “Board of Forestry Technical Rule Addendum Number 5: Guidance on Hydrologic Disconnection, Road Drainage, Minimization of Diversion Potential, and High Risk Crossings” (1st Edition, revised 04/21/15), hereby incorporated by reference.

(p) All Logging Road Watercourse crossings that are proposed by the plan submitter to be removed, including temporary crossings and those along abandoned or deactivated roads, shall be removed as described in the plan and shall apply the following standards:

CALIFORNIA FOREST PRACTICE RULES

(1) Fills shall be excavated to form a channel that is as close as feasible to the natural Watercourse grade and orientation, and that is wider than the natural channel as observed upstream and downstream of the Logging Road Watercourse crossing to be removed.

(2) The excavated material and any resulting cut bank shall be no greater than 65 percent (1.5:1, horizontal to vertical) from the outside edge of the constructed channel to prevent slumping, to minimize soil erosion and sediment transport, and to prevent significant sediment discharge. Exposed soil located between the Watercourse crossing and the nearest adjacent drainage facility or hydrologic divide, whichever is closer, including cut banks and excavated material, shall be stabilized by seeding, mulching, rock armoring, replanting, or other suitable treatment to prevent soil erosion and significant sediment discharge.

(3) Where it is not feasible to remove a Logging Road Watercourse crossing or its associated fill to the above standards, the plan shall identify how soil erosion and significant sediment discharge will be prevented.

(4) All Logging Road Watercourse crossings proposed for removal shall be removed upon completion of use, prior to the winter period or as specified in the applicable CDFW 1600 agreement, whichever is earlier, or as otherwise specified in the plan.

(q) Logging Road Watercourse crossings shall not be constructed or Reconstructed under saturated soil conditions or when such activities could result in significant sediment discharge.

(r) Temporary Logging Road Watercourse crossings shall be removed and stabilized prior to the winter period or as specified in the plan.

(s) In watersheds with listed anadromous salmonids and in planning watersheds immediately upstream of, and contiguous to, any watershed with listed anadromous salmonids, where construction or reconstruction is proposed during the extended wet weather period, no Timber Operations shall take place unless the approved plan incorporates a complete winter period operating plan pursuant to 14 CCR § 914.7(b) [934.7(b), 954.7(b)] that specifically addresses such construction or reconstruction.

(t) The following stabilization standards shall apply to Logging Road Watercourse crossings:

(1) Soil stabilization measures shall be described in the plan and may include, but are not limited to, removal, armoring with rip-rap, replanting, mulching, seeding, installing commercial erosion control devices to manufacturer's specifications, or chemical stabilizers.

(2) Bare soil on fills or sidecast associated with Logging Road Watercourse crossings that are created or exposed by Timber Operations shall be stabilized to the extent necessary to minimize soil erosion and sediment transport and to prevent significant sediment discharge. Erosion control measures for the traveled surface of roads and Landing surfaces are specified in 14 CCR §§ 923.5 [943.5, 963.5] and 923.7 [943.7, 963.7]. Sites to be stabilized include, but are not limited to, sidecast or fill exceeding 20 feet in slope distance from the outside edge of the road surface at the Logging Road Watercourse crossing.

(3) Soil stabilization treatments shall be in place upon completion of operations for the year of use or prior to the extended wet weather period, whichever comes first. An exception is that bare areas created during the extended wet weather period shall be treated prior to the start of rain that generates overland flow, or within 10 days of the creation of the bare area(s), whichever is sooner, or as agreed to by the Director.

(4) In watersheds with listed anadromous salmonids and in planning watersheds immediately upstream of, and contiguous to, any watershed with listed anadromous salmonids, treatments to stabilize soils, minimize soil erosion, and prevent significant sediment discharge within the WLPZ and within any ELZ or EEZ designated for Watercourse or lake protection shall be described in the plan as follows:

(A) In addition to the requirements of 14 CCR § 923.9(p)(1)-(3) [943.9(p)(1)-(3), 963.9(p)(1)-(3)], soil stabilization is required for the following:

1. Areas exceeding 100 continuous square feet where Timber Operations have exposed bare soil.
2. Disturbed Logging Road Watercourse crossing cut banks and fills.
3. Any other area of disturbed soil that threatens to cause significant sediment discharge.

(B) Where straw mulch is used, the minimum straw coverage shall be 90 percent, and any treated area that has been reused or has less than 90 percent surface cover shall be treated again by the end of Timber Operations.

CALIFORNIA FOREST PRACTICE RULES

(C) Where Slash mulch is applied, Slash coverage in contact with the ground surface shall be a minimum of 75 percent.

(D) For areas disturbed outside the extended wet weather period, treatment shall be completed prior to the start of any rain that causes overland flow across or along the disturbed surface that could result in significant sediment discharge.

(E) For areas disturbed during the extended wet weather period, treatment shall be completed prior to any day for which a chance of rain of 30 percent or greater is forecast by the National Weather Service or within 10 days of disturbance, whichever is earlier.

(u) Logging Road Watercourse crossings shall be monitored and maintained during Timber Operations and throughout the prescribed maintenance period as needed, to comply with 14 CCR § 1050. The prescribed maintenance period is specified in 14 CCR § 923.7(i)-(j) [943.7(i)-(j), 963.7(i)-(j)]. Monitoring inspections shall be conducted, when access is feasible during the prescribed maintenance period, a sufficient number of times during the extended wet weather period, particularly after large winter storm events and at least once annually, to evaluate Watercourse crossing function. The Department shall also conduct monitoring inspections at least once during the prescribed maintenance period to assess Watercourse crossing conditions.

(1) Inspections shall include checking Watercourse crossings for evidence of downcutting, plugging, overtopping, loss of function, and sediment delivery to Class I, II, or III Watercourses and lakes. If evidence of sediment delivery or potential sediment delivery is present, and the implementation of feasible corrective measures could reduce the potential for significant sediment discharge, such additional measures shall be implemented when feasible.

(2) Inspections conducted pursuant to California Regional Water Quality Control Board requirements may be used to satisfy the inspection requirements of this section.

(v) Logging Road Watercourse crossings shall be maintained as designed, constructed, and Reconstructed during Timber Operations and throughout the prescribed maintenance period. Crossings used in connection with stocking activities shall be maintained throughout such use, even if this extends beyond the prescribed maintenance period.

923.9.1, 943.9.1, 963.9.1. Licensed Timber Operator Responsibility for Roads and Landings [All Districts].

The licensed Timber Operator who is responsible for the implementation or execution of the plan shall not be responsible for the construction and maintenance of roads and Landings, unless the licensed Timber Operator is employed for that purpose.

BOARD OF FORESTRY TECHNICAL RULE ADDENDUM NO. 5: GUIDANCE ON HYDROLOGIC DISCONNECTION, ROAD DRAINAGE, MINIMIZATION OF DIVERSION POTENTIAL, AND HIGH RISK CROSSINGS (1st EDITION, revised 10/27/14)

Purpose

The purpose of this technical rule addendum is to provide guidance to Registered Professional Foresters (RPFs), Licensed Timber Operators (LTOs), Timberland Owners, and agency personnel on hydrologic disconnection of road segments and Logging Road drainage, as required by the Forest Practice Rules pursuant to 14 CCR § 923 et seq. [943 et seq., 963 et seq.]. Logging Roads cannot be completely disconnected from Watercourses in all locations. This addendum provides assistance in understanding where disconnection is necessary and where site-specific field observations indicate that key areas and problem indicators combine to result in significant existing or potential erosion sites. The information contained herein is designed to be integrated with site-specific evaluation of Logging Road conditions in the field.

Part I of this addendum presents an introduction to the concept of hydrologic disconnection, a method to evaluate existing hydrologic connectivity, and treatment measures available to achieve hydrologic disconnection. Part II contains guidance on the appropriate location of drainage facilities and structures, installation of energy dissipaters, road surface outsloping, and placement of rolling dips. Part III describes diversion potential at Watercourse crossings and the importance of critical dip installation. Part IV describes crossings with higher risk of failure and potential approaches that can be used to reduce the risk of catastrophic failure. Part V concludes with a table and several figures that illustrate the concepts discussed in

CALIFORNIA FOREST PRACTICE RULES

the text of the addendum.

I. Hydrologic Disconnection

As defined in 14 CCR § 895.1, hydrologic disconnection means the removal of direct routes of drainage or overland flow of road runoff to a Watercourse or lake. The goal of hydrologic disconnection is to minimize sediment delivery and hydrologic change derived from road runoff being routed to a Watercourse (Refer to Figure 1). Hydrologic disconnection is achieved by creating a road surface and drainage configuration that directs water to discharge from the road in a location where it is unlikely to directly flow into a Watercourse. Hydrologic disconnection can be accomplished by directing road runoff onto effective filter strips. Filter strips should have high infiltration capacity and dense vegetation and/or obstructions (e.g., woody debris, Slash) to dissipate energy, facilitate percolation, and resist or prevent erosion and channelization. Hydrologic connectivity increases the potential for the road segment to deliver road-derived sediment and road chemicals, including spills, to a Watercourse. When roads are connected to Watercourses, this effectively increases the drainage density of the watershed, producing hydrologic changes that can alter the magnitude and frequency of runoff delivery to Watercourses. The proportion of road prisms that are hydrologically connected is strongly controlled by road location, road design, road maintenance, local topography, geology, and factors that control the amount of road runoff (e.g., the amount of annual precipitation).

Hydrologically connected roads can deliver water and sediment via inside ditches that drain to a Watercourse crossing; by a connected road drainage structure or facility (i.e., ditch drain culvert, rolling dip, waterbreak, or lead-off inside ditch that delivers runoff to a Watercourse channel); or by direct runoff from the road running surface to a Watercourse at road crossings (Refer to Figure 1). **In the western U.S., road-Watercourse crossings account for the majority of the connected road length**, followed by gullies formed by concentrated runoff at drainage structure or facility outlets. Evidence of connection below a road drainage structure or facility is provided by: (1) indication of surface flow between the drainage structure outlet and a defined channel or a flood prone area; (2) a channel that extends from a road drainage structure outlet to the high water line of a defined channel or a flood prone area; (3) a sediment deposit that reaches the high water line of a defined channel or a flood prone area; (4) observation of turbid water reaching the Watercourse during runoff events; or (5) indications of channel widening and/or incision below a drainage structure resulting from increases in flow.

Primary mechanisms for decreasing hydrologic connectivity are: (1) installation of a “disconnecting” drainage facility or structure close to the Watercourse crossing; (2) increasing the frequency of ditch drain (relief) culvert spacing for roads with inside ditches; (3) converting crowned or insloped roads with inside ditches to outsloped roads with rolling dips; (4) removing or breaching outside berms on crowned or outsloped roads to facilitate effective drainage; (5) applying treatments to dissipate energy, disperse flows, and minimize erosion at road drainage outlets not connected to Watercourses; and (6) avoiding concentration of flows onto unstable areas. In particular, the distance between a Watercourse crossing and the first upslope adequately functioning and sized road drainage facility or structure is of high importance because this distance has a large influence on the volume of water and sediment delivered to a Watercourse.

Not all road segments are hydrologically connected and complete hydrologic disconnection is not possible for most roads. For example, insloped road segments with an inside ditch will generally include a segment that is connected between the Watercourse and first road drainage facility or structure located up-grade from the Watercourse crossing (Refer to Figure 2). The likelihood of connectivity generally decreases rapidly as the distance between the road and the Watercourse increases. Low delivery potential roads also include road segments on flat terrain that do not intersect Watercourse channels. For all existing road segments where hydrologic connection may be present, 14 CCR § 923.1(e) [943.1(e), 963.1(e)] requires that an evaluation be conducted to identify which segments need to be disconnected and how the disconnection will occur.

A. Key Areas to Evaluate for Hydrologic Connectivity

When evaluating the hydrologic connectivity of Logging Roads, particular attention should be devoted to

CALIFORNIA FOREST PRACTICE RULES

identifying road segments with a high number of Watercourse crossings and those located close to Watercourses (e.g., <200 feet). Key areas to consider in this context include, but are not limited to:

- Road segments with road drainage structure or facility outlets near Watercourses.
- Insloped or crowned road segments with inside ditches.
- Crowned or outsloped road segments with outside berms.
- Steep road or ditch grades (e.g., > 7 percent).
- Roads on steep hillslope gradients (e.g., > 40 percent).
- Roads located on lower hillslope positions (as opposed to mid-slope and upper hillslope positions).
- Throughout and incised road segments that are difficult to adequately drain.
- Areas with relatively high hillslope instability (e.g., Franciscan mélange terrain).
- Areas with high precipitation amounts and intensity, and/or high levels of snowmelt runoff (e.g., transient and seasonal rain-on-snow zone).
- Road segments with surfaces prone to erosion (e.g., non-cohesive soils such as decomposed granitic soils) and/or significant rutting from intensive use.
- Road segments with wet weather use.
- Areas with little surface roughness or vegetative cover (e.g., areas recently burned), or compacted soils with low infiltration capacities.
- Unsurfaced roads that are graded on a regular basis.
- Inside ditches that are graded on a regular basis.
- Roads with high traffic volumes (e.g., primary roads in a road network, as opposed to secondary, low-use roads).
- Roads with maintenance issues (e.g., road segments with damaged or plugged drainage structures) and/or limitations regarding ownership or control (e.g., public roads, private non-appurtenant roads, roads with unauthorized use).

B. Indicators of Significant Existing or Potential Problems

Indicators of significant existing or potential problems with the existing road drainage conditions include, but are not limited to:

- Evidence of direct sediment entry into a Watercourse or a flood prone area from road surfaces or drainage structures and facilities (e.g., ponded sediment, sediment deposits, delivery of turbid runoff from drainage structures during rainfall events).
- Ditch scour or downcutting resulting from excessively long undrained ditches with infrequent ditch drain (relief) culverts or other outlet structures or facilities. This condition can also result from design inadequacies (e.g., spacing not altered for steep ditch gradient), inadequate erosion prevention practices (e.g., lack of armoring), or ditches located in areas of erodible soils.
- Gullies or other evidence of erosion on road surfaces or below the outlets of road drainage facilities or structures, including ditch drain (relief) culverts, with transport or a high likelihood of transport to a Watercourse.

Additionally, if a road and/or ditch runoff is hydrologically connected to a Watercourse, the following factors elevate the risk of sediment delivery to a Watercourse:

- Existing or high potential for cutbank sloughing or erosion into inside ditches.
- Native-surfaced road exhibiting erosion.
- Native-surfaced road composed of erodible soil types (e.g., granitic soils).
- Rilled, gullied, or rutted road approaches to crossings.
- Existing ditch drain (relief) culverts or other road drainage structures with significant plugging from sediment and/or small woody debris.
- Existing ditch drain (relief) culverts or other road drainage structures with decreased capacity due to

CALIFORNIA FOREST PRACTICE RULES

- damage or impairment (e.g., crushed or bent inlets, flattened dips due to road grading).
- Decreased structural integrity of ditch drain (relief) culverts, waterbreaks, or other road drainage structures (e.g., excessive culvert corrosion, breached waterbreaks, or rutted road segments).

C. Design and Treatment Measures to Achieve Hydrologic Disconnection

Treatment measures for existing Logging Roads are necessary where site-specific field observations indicate that key areas and problem indicators combine to result in significant existing or potential erosion sites. Proposed and Reconstructed Roads should be designed to achieve hydrologic disconnection to the extent feasible. Additional restrictions and requirements specified under 14 CCR § 923.4(a) [943.4(a), 963.4(a)] apply for new or Reconstructed roads, while 14 CCR §§ 923.5(a) [943.5(a), 963.5(a)], and 923.6(g) and (h)(3) [943.6(g) and (h)(3), 963.6(g) and (h)(3)] apply to existing roads.

Measures to hydrologically disconnect Logging Road segments include, but are not limited to:

- Installation of a road drainage facility or structure as close as possible to the Watercourse crossing. Typically, this distance is 30 to 100 feet above the crossing (Refer to Figure 2), but may be up to 200 feet or more based on road drainage design and site-specific conditions. For example, the distance from the Watercourse crossing to the road drainage facility or structure might be based on the location of where the buffering capacity of the filter strip is the greatest (i.e., densest vegetation and ground cover). Note that this spacing may be closer than the maximum distance specified under 14 CCR § 923.5(f) [943.5(f), 963.5(f)], or as needed for conformance with 14 CCR § 923.5(g) [943.5(g), 963.5(g)]. Depending on the road drainage design, the road drainage facility or structure can be a ditch drain (relief) culvert, rolling dip, waterbreak, or other effective facility or structure. Surface drainage designs or facilities that concentrate runoff (e.g., crowned or insloped road surfaces) require more buffering distance between the drainage outlet and the Watercourse than those that disperse runoff (e.g., outsloped road surfaces).
- Installation of additional road drainage facilities or structures above (upgrade of) the closest road drainage facility or structure to the Watercourse crossing that are appropriately sized and located in conformance with 14 CCR § 923.5(b) and (c) [943.5(b) and (c), 963.5(b) and (c)]. Maximum waterbreak spacing for roads is specified under 14 CCR § 923.5(f) [943.5(f), 963.5(f)]. Appropriate spacing for rolling dips is considered in Section II.C. of this Technical Rule Addendum.
- Installation of ditch drains that are sufficiently spaced to: minimize ditch scour, prevent exceedance of ditch drain hydraulic capacity, and minimize erosion at drain outlets. Local experience, knowledge and site-specific conditions (e.g., hydrology, soil and geologic material present) should be considered by the RPF in the location and spacing of ditch drains. Spacing of ditch drains should be adjusted in response to: (1) poor filtering capacity or potentially unstable areas at the outlet (additional factors are listed in the following section), and (2) proximity to a Watercourse. Near a Watercourse, the ditch drain spacing should be closer so that smaller amounts of flow are routed down the ditchline, thus providing an added factor of safety for high flow conditions and potential failure of drainage facilities. An example of ditch drain (relief) spacing guidelines is displayed in Table 1 (see Section IV V of this addendum). In the preparation of THPs, NTMPs, and PTHPs, RPFs may develop and use other spacing guidelines that better match the field conditions where their plans are proposed. For example, the RPF can observe the length of road necessary to initiate significant fill erosion and use these observations to adjust spacing guidelines to local conditions.
- In general, if ditch drain (relief) culverts are used, they are recommended to be at least 18 inches in diameter to lower the potential for plugging from soil and small woody debris.
- Elevation of the crossing slightly above the road grade to ensure that the crossing (e.g., bridges or relatively flat road approaches) does not serve as the low point for road surface runoff (Refer to

CALIFORNIA FOREST PRACTICE RULES

Figures 2 and 7). Where applicable, this does not alleviate the necessity for installation of a critical dip to mitigate diversion potential.

- Installation of outside berms to decrease hydrologic connectivity where they direct flow to a more suitable discharge area.

Many road segments will have a small portion of their length still connected, even following implementation of 14 CCR §§ 923.2(a)(5) [943.2(a)(5), 963.2(a)(5)], 923.5(a) [943.5(a), 963.5(a)], and 923.6(g) and (h)(3) [943.6(g) and (h)(3), 963.6(g) and (h)(3)]. Additionally, treatment of road approaches for connected road segments next to Watercourses may be necessary pursuant to 14 CCR § 923.5(i) [943.5(i), 963.5(i)].

II. Road Drainage, Energy Dissipation, Outsloping and Rolling Dips

A. Location of Drainage Facilities and Structures

In addition to drainage structures and facilities being located: (1) to disconnect road drainage upslope of Watercourses, and (2) at a sufficient interval (spacing) to avoid volume concentrations and associated erosion, as discussed above, there are additional factors that should be considered prior to placing drainage structures and facilities in the field. To assist in identifying sites best suited for a drainage structure or facility, the following criteria should be considered. These criteria should be evaluated and appropriately weighted based on site-specific conditions, so that the effectiveness of the drainage structure or facility is maximized and potential problems are avoided or minimized. RPFs should maintain or restore natural drainage patterns as much as possible, while considering the factors listed below. Drainage structures and facilities should be placed:

- To avoid the concentration of flow onto unstable or potentially unstable areas, such as known active landslides, hummocky ground, concave headwalls, or steep fillslopes.
- To discharge onto divergent (convex) to planar slopes where possible, to allow for better dispersion and infiltration (Refer to Figure 3).
- Before hydrologic divides to prevent water from one hydrologic basin mixing with, and potentially impacting, another hydrologic basin not conditioned to receiving the additional flows.
- Above breaks in the road grade that transition from low-gradient to high-gradient to remove the water off of the road before it gains velocity and erosive power on the downslope steep road segment.
- To drain localized or emergent groundwater, springs, and wet areas present in the road prism.

B. Installation of Energy Dissipaters for Drainage Structures and Facilities

Where the natural topography, soil surface texture, and vegetation is inadequate to dissipate the energy of flowing water, energy dissipaters (e.g., Slash, rock armor, flow diverters, downspouts, etc.) should be placed at outfalls of drainage structures and facilities to disperse flows and promote infiltration, consistent with the requirements stated in 14 CCR § 923.5(h) [943.5(h), 963.5(h)]. The use and selection of an appropriate energy dissipater should be based on field conditions and is a function of flow, erosion characteristics of the soils, slope gradient, slope roughness and cover, and distance to a receiving Watercourse. Effective energy dissipaters commonly used in the forest setting, include, but are not limited to:

- Dense vegetative ground cover.
- Wood Slash that is “packed” into place with heavy equipment (ideally) or by hand.
- Pit-run rock. Generally composed of competent local rock that has a range of rock sizes and is of sufficient size to resist movement from road runoff.
- Properly located, sized, and maintained stilling basins.

C. Logging Road Outsloping and Installation of Rolling Dips

CALIFORNIA FOREST PRACTICE RULES

Outsloped roads are built with a slight angle of the road surface towards the outside edge (Refer to Figure 4). This configuration allows road surface runoff to drain in a dispersed manner over the fillslope onto undisturbed forest soils. As defined in 14 CCR § 895.1, outsloping means shaping the road surface to drain toward the outside edge of the Logging Road or Landing.

Rolling dips are typically constructed on outsloped roads to ensure adequate drainage of the road surface. As defined in 14 CCR § 895.1, a rolling dip means a drainage facility that is constructed to remain effective while allowing passage of motor vehicles at reduced road speeds.

An outsloped road's running surface is considered hydrologically disconnected as long as runoff is effectively transported across rather than down the road surface, outside berms do not restrict runoff, and the road prism does not encroach upon the Watercourse. Rolling dips should be installed on outsloped roads to ensure that surface flow is routed off the road surface in situations where outsloping alone may not be effective to prevent concentrating flow or eroding the fill (Refer to Figure 5). Outsloped roads with rolling dips are typically not appropriate for roads with a gradient in excess of ten percent (10%) because of the steepness of the dip approach grades that would be required and the added difficulty to effectively drain the road surface. The maximum amount of outsloping achievable depends on the type of traffic that will use the road (e.g., lowboys, log trucks, pickup trucks) and the road surfacing. Outsloped roads are not appropriate in all situations due to safety concerns, timing of use, or expected traffic (e.g., winter use in snow zones). The spacing of rolling dips must be in conformance with 14 CCR § 923.5(g) [943.5(g), 963.5(g)]. As with ditch drain (relief) culvert location, the location of rolling dips is to be modified based on the site buffering capacity at proposed installation locations and avoidance of concentrated flow onto unstable areas. Spacing of rolling dips is a function of: (1) road grade, soil erodibility, and road surface area draining to the dip, and (2) proximity to a Watercourse. Near a Watercourse, the rolling dip spacing should be closer so that smaller amounts of flow are routed towards each dip, thus providing an added factor of safety for high flow conditions and potential failure of drainage facilities. Local experience and knowledge of soil and geologic material present should be considered by the RPF in the location and spacing of rolling dips. An example of general rolling dip spacing guidelines is displayed in Table 1. In the preparation of THPs, NTMPs, and PTHPs, RPFs may develop and use other spacing guidelines that better match the field conditions where their plans are proposed.

III. Diversion Potential at Watercourse Crossings and Critical Dip Installation

Diversion potential at Watercourse crossings is typically associated with large storm events, and can be a significant source of erosion and sediment. Watercourse crossings have diversion potential if overflow at a plugged culvert inlet diverts the Watercourse down the road rather than over the crossing and back into the natural Watercourse channel. Diverted flows can create excessive erosion where the flows erode non-channeled surfaces and where they exceed the channel capacity of non-original channels. Diversion potential exists on roads that have a continuous climbing grade across the crossing or where the road slopes downward away from the crossing in at least one direction (Refer to Figure 6). Forest Practice Rules 14 CCR § 923.9(k) [943.9(k), 963.9(k)] requires diversion potential on constructed (new) and existing Logging Roads to be addressed; similar requirements have existed since 1990. As specified in 14 CCR § 923.9(j) [943.9(j), 963.9(j)], critical dips are incorporated into the construction or reconstruction of Logging Road Watercourse crossings utilizing culverts, except where diversion of overflow is addressed by other methods stated in the plan. The critical dip should be constructed at the point where the potential for erosion and the loss of fill is minimized (Refer to Figure 7).

IV. Crossings with Higher Risk of Failure and Higher Risk to the Environment

Some Watercourse crossings have a higher relative risk of failure due to the landscape in which they are installed (e.g., areas prone to debris flows or landsliding); or due to seasonal lack of access or remoteness, both of which limit effective emergency maintenance. Additionally, crossings that employ larger than typical fills to achieve running surface elevations often present a higher risk to the environment if they fail due to the large volumes of fill that could be introduced to downstream Watercourses. In these cases, it is recommended and/or required (Forest Practice Rule 14 CCR § 923.9(o) [943.9(o), 953.9(o)]) that such

CALIFORNIA FOREST PRACTICE RULES

crossings be oversized, designed for low maintenance, reinforced, or removed before the completion of Timber Operations. As discussed in *Designing Watercourse Crossings for 100-year Flood Flows, Wood and Sediment* (Cafferata et al., 2004), where temporary crossings are not used, rock ford or rock armored fill crossings are often a better alternative to culverts on small to medium sized Watercourses in areas where winter maintenance is difficult or debris flows are more likely; the same holds true in areas prone to earthflows or other types of landsliding. Overall, fords (including native surface, rock, armored fill, and vented) are more apt to effectively transport flows, sediment, and debris in unstable landscapes and areas with poor access for emergency monitoring and repairs than culvert crossings. Where culverts are used, and fills are large, Cafferata recommends that the diameter of the culvert be increased by 6 inches for every 5 feet of fill above the culvert on the discharge side of the crossing. The additional culvert diameter reduces the risk of failure by allowing more room for transport of flow, sediment and debris, and is relatively inexpensive compared to the cost of replacement of a failed crossing. Crossings may also be reinforced by utilizing large rock designed to resist movement during high flows to line fill faces and by incorporating large critical dips to allow flow passage if the culvert becomes plugged. Temporary crossings typically provide the least environmental risk since flow is unimpeded after the crossings are removed.

V. Table and Figures

The following table and figures are provided as examples to illustrate design concepts. These are not intended to serve as default performance standards.

Table 1. An example of ditch-relief culvert and rolling dip spacing guidelines is found in the University of California's Publication 8262, *Rural Roads: A Construction and Maintenance Guide for California Landowners* (Kocher et al. 2006, adopted from Keller and Sherar 2003). Note that spacing of rolling dips and ditch relief culverts should be a function of proximity to a Watercourse, with closer spacing near the channel.

Road Grade (percent)	Soil Erodibility	
	Low to Non-erosive soils	Erosive soils
0-3%	400'	250'
4-6%	300'	160'
7-9%	250'	130'
10-12%	200'	115'
12+	160'	100'

- Note:** (1) **Low Erosion Soils** = Coarse Rocky Soils, Gravel, and Some Clay
 (2) **High Erosion Soils** = Fine, Friable Soils, Silt, Fine Sands

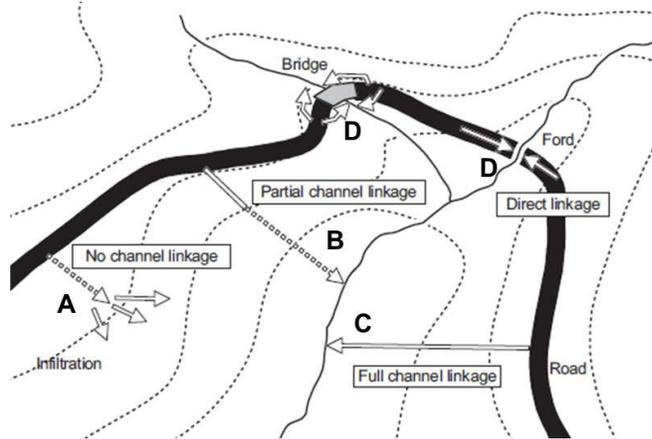
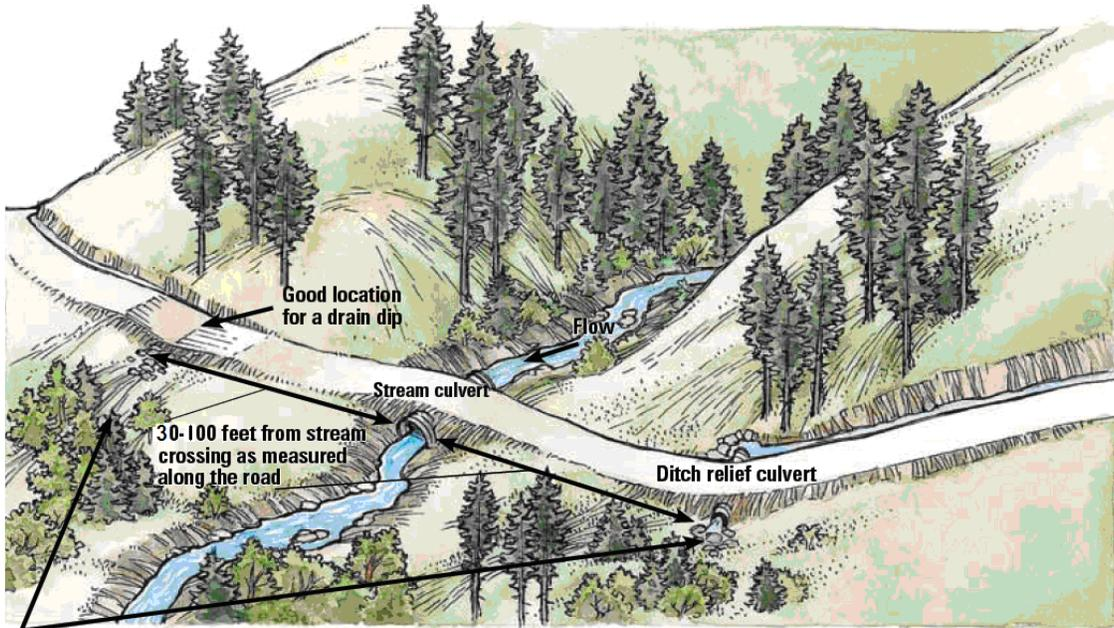

Figure 1. The range of hydrologic connectivity (i.e., linkage) for a road. Ideally, road runoff is drained to an effective filter strip where runoff and sediment is dispersed onto the forest floor (A). Roads can be partially connected when a portion of runoff and sediment reaches the Watercourse (B). Full hydrologic connectivity can occur when road runoff initiates channels or gullies (C), or is drained directly into Watercourses at road crossings (D). Figure adapted from Croke and Hairsine, 2006.



Ditch drainage should be directed into vegetation and undisturbed soil filter, and not allowed to continue flowing down the ditch and into the stream.

Figure 2. Diagram showing implementation of road drainage disconnection facilities/structures to limit sediment delivery into a Watercourse. Note the absence of an apparent critical dip at the crossing. (modified from Oregon Forest Resources Institute 2011, 2nd Ed., used with permission).

CALIFORNIA FOREST PRACTICE RULES

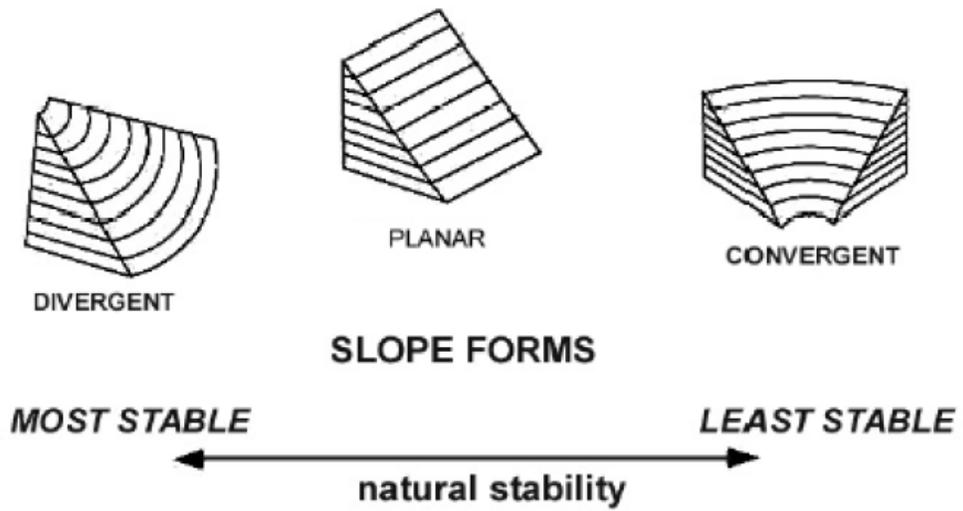

Figure 3. Three major slope forms; water should be discharged onto divergent (convex) to planar slopes where possible (from WFPB 2004).

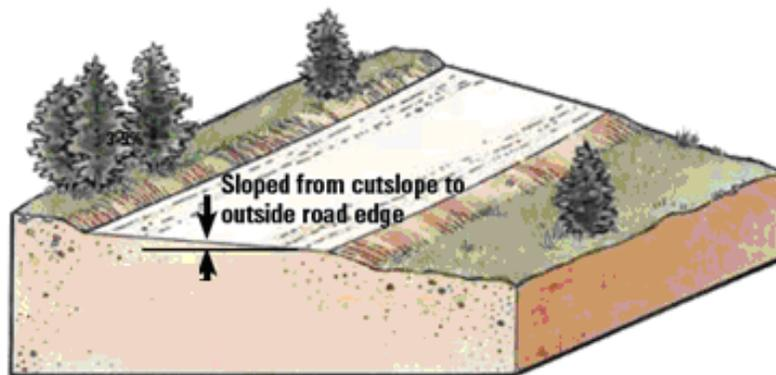

Figure 4. Diagram displaying a typical outsloped road (modified from Oregon Forest Resources Institute 2011, 2nd Ed., used with permission).

CALIFORNIA FOREST PRACTICE RULES

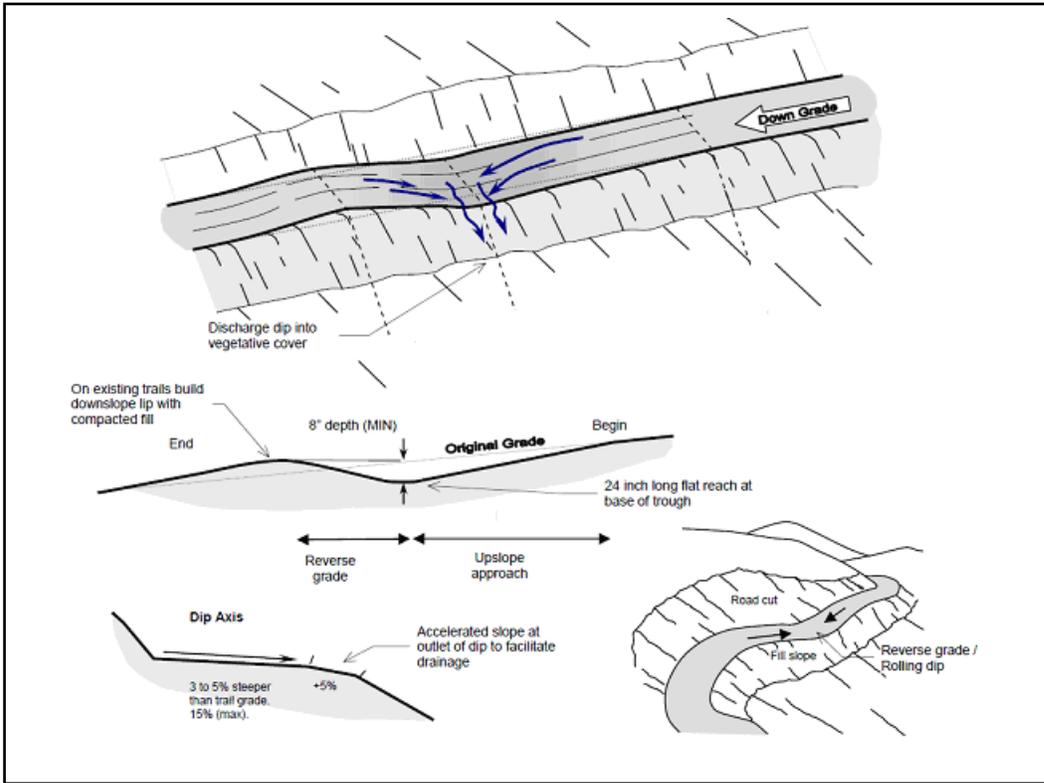

Figure 5. Example of rolling dip specifications (modified diagram provided by Tim Best, CEG).

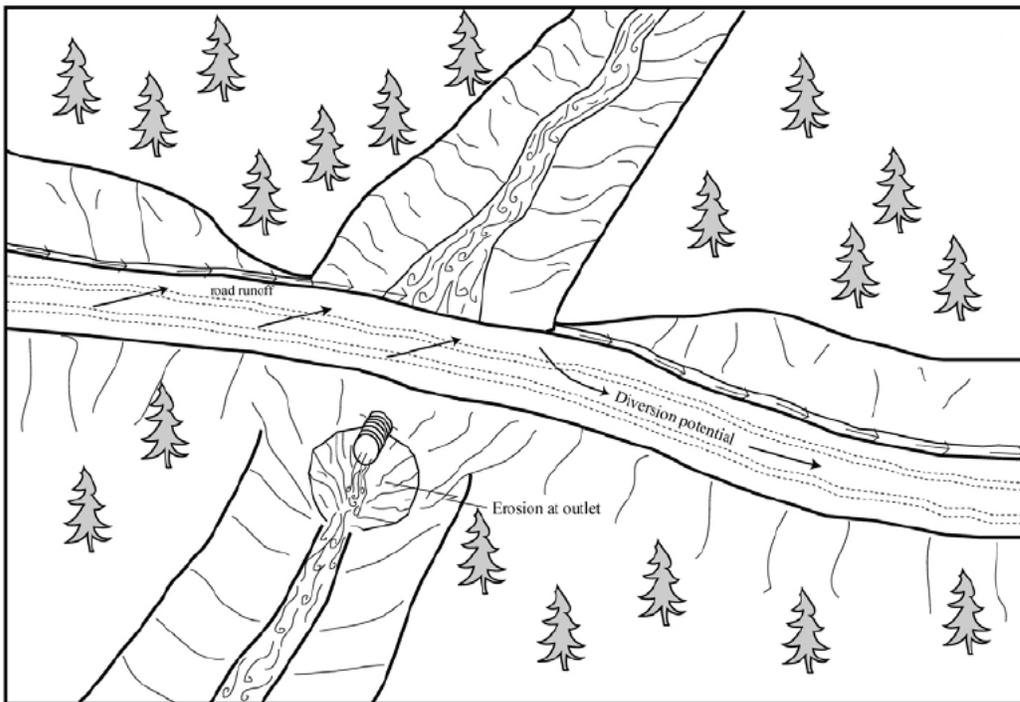

Figure 6. Diagram illustrating diversion potential at a Watercourse crossing (from DFG 2006).

CALIFORNIA FOREST PRACTICE RULES

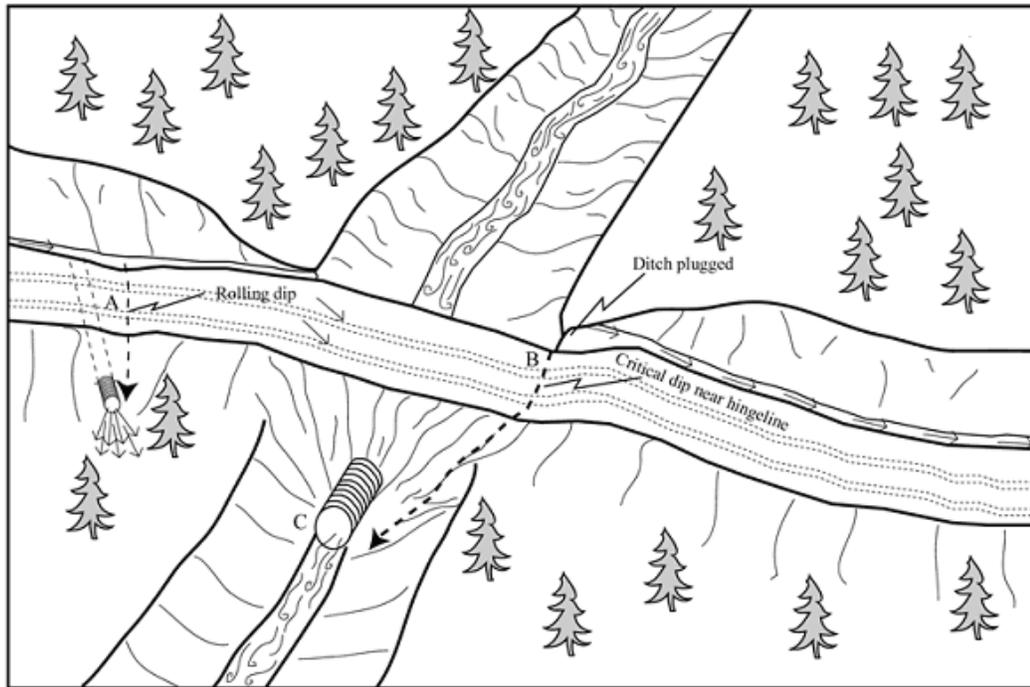

Figure 7. Illustration of a critical dip installed at a Watercourse crossing to remove diversion potential (from DFG 2006). The critical dip should be constructed at the point where the potential for erosion and the loss of fill is minimized.

Article 13 County Rules

924 County Rules Within the Southern Subdistrict of the Coast Forest District [Coast, SSD]

In lieu of 14 CCR 1032.7 subsections (c), (e), (f), (g), and (h)(1) and 1037, the Rules contained in 924.1 through 924.5 shall apply in any county for which Rules have been adopted pursuant to PRC 4516.5.

924.1 Plan Submittal and Notice of Intent [Coast, SSD]

(a) The plan submitter shall prepare and submit to the Director, with the plan, a Notice of Intent to Harvest Timber as described in 14 CCR 1032.7(d).

(b) The plan submitters shall furnish to the Department at the time of submission of the plan the names and addresses of an property owners within 300 ft. of the exterior boundaries of assessor's parcels upon which a plan has been submitted, and the names and addresses of property owners with property fronting or bordering that portion of the haul route lying between the plan area and the nearest public road. The list shall be compiled from the latest equalized assessment roll of the county or a list provided by a title insurance company.

(1) The plan submitter shall submit business size envelopes stamped with first class postage properly addressed to the property owners identified in (b). These will be used by the Department for mailing the Notice of Filing.

(c) The plan submitter shall mail copies of the Notice of Intent to all names in (b) prior to plan submission. At the time of plan submission, the plan submitter shall certify in writing that this procedure has been followed.

(d) For plan amendments, the submitter of the amendment shall certify in writing at the time the amendment is submitted that copies of a new Notice of Intent have been mailed to:

(1) All property owners not previously noticed under subsection (b) who, because of the plan amendment, would be required to receive the notice provided for in subsection (b).

(2) All property owners previously noticed under subsection (b) when there is a change in silvicultural method.

CALIFORNIA FOREST PRACTICE RULES

924.2 Plan Filing [Coast, SSD]

A plan found by the Director to be accurate, complete and in proper order shall be filed on the 10th day following the date of its receipt by the Department. When the Director finds a plan inaccurate, incomplete, or otherwise not in proper order, the plan shall be returned to the submitter with written specifications of the deficiencies.

924.3 Preharvest Inspection [Coast, SSD]

On or before the date the plan is filed, the Director shall determine if a preharvest inspection is necessary. A preharvest inspection shall be conducted on all plans for which a public hearing is to be held.

924.4 Notice of Filing [Coast, SSD]

In addition to those items required by 14 CCR 1037.1, the following shall apply:

(a) The Notice of Filing shall contain:

(1) The date, time and location of the public hearing, when applicable.

(2) The Director shall include the date, time and location of the review team meeting if it is known.

(b) Within two working days of the date the plan is filed, the Director shall send copies of the Notice of Filing to:

(1) All property owners listed in 14 CCR 924.1(b).

(2) A newspaper of general distribution in the area.

924.5 Agency and Public Review [Coast, SSD]

In addition to the requirements of 14 CCR 1037.3, the following shall apply: The Director shall send a copy of the filed plan to any local public water agency that makes written request for it and the appropriate local school district.

CALIFORNIA FOREST PRACTICE RULES

COUNTY RULES, COAST DISTRICT

925 Santa Clara County Rules [Santa Clara County]

In addition to forest practice Rules applying in the Coast Forest District and Southern Subdistrict of the Coast Forest District, Rules contained in 925.1 to 925.10 shall apply within the boundaries of Santa Clara County. These Rules are for all of Santa Clara County, including that portion in the Southern Forest District. Where the general Rules conflict with Santa Clara County Rules, the Santa Clara County Rules shall apply.

925.1 Winter Period [Santa Clara County]

The winter period for Santa Clara County shall be October 15 through April 15.

925.2 Plan Submittal and Notice of Intent [Santa Clara County]

14 CCR 1032.7 subsections (c), (e), (f), (g), and (h)(1), shall not apply in Santa Clara County. In lieu of those subsections, the following shall apply:

(a) The plan submitter shall prepare and submit to the Director, with the plan, a Notice of Intent to Harvest Timber as described in 14 CCR 1032.7(d).

(b) The plan submitter shall furnish to the Department at the time of submission of the plan the names and addresses of all property owners within 300 ft. of the exterior boundaries of assessor's parcels upon which a plan has been submitted, and the names and addresses of property owners with property fronting or bordering that portion of the haul route lying between the plan area and the nearest public road. The list shall be compiled from the latest equalized assessment roll of the county or a list provided by a title insurance company.

(c) The plan submitter shall mail copies of the Notice of Intent to any names in (b) prior to plan submission. At the time of plan submission, the plan submitter shall certify in writing that this procedure has been followed.

(d) For plan amendments, the submitter of the amendment shall certify in writing at the time the amendment is submitted that copies of a new Notice of Intent have been mailed to:

(1) All property owners not previously noticed under subsection (b) who, because of the plan amendment, would be required to receive the notice provided for in subsection (b).

(2) All property owners previously noticed under subsection (b) when there is a change in silvicultural method.

925.3 Plan Distribution [Santa Clara County]

Within two working days of the date of the receipt of the plan, the Director shall transmit copies of the plan to:

(a) The local school district within which the plan is located.

(b) The Santa Clara Valley Water District.

925.4 Contents of the Plan [Santa Clara County]

14 CCR 1034, subsection (g) and that portion of (x) pertaining to map size shall not apply in Santa Clara County (all of subsections (x)(1) through (x)(14) shall apply.). In lieu of those subsections, the following shall apply:

(a) A description of the plan area within which Timber Operations are to be conducted. The description shall include the following:

(1) U.S. Geological Survey (USGS) Quadrangle name(s) and date(s),

(2) township, range, and section number(s),

(3) county name(s),

(4) CALWATER 2.2 planning watershed number(s),

(5) approximate acreage, and

(6) assessor's parcel number(s) for the assessor's parcels within which a plan is submitted.

(b) The estimated number of logging truck loads to be removed and the approximate number of daily trips.

(c) The following information shall be clearly provided on a reproducible 1" = 500' topographic map

CALIFORNIA FOREST PRACTICE RULES

showing 40 ft. contour intervals, provided such maps are available from the county at nominal cost. Additional maps may be required to show specific details, and may be planimetric. Color coding shall not be used. A legend shall be included indicating the meaning of the symbols used. See district Rules for the appropriate minimum mapping acreages.

(1) The location of scenic roads as designated by the County General Plan or in another document officially adopted by the county.

(2) Location of all structures (including mobile homes or trailers) currently maintained for human habitation within 200 ft. as measured along the surface of the ground from the boundary of the plan area.

(d) On Timber Operations requiring submission of a plan, all routes to be used for removing forest products from the plan area to the mill or county line shall be shown on a road map submitted with the plan. A proposed change in the use of public roads that are part of the haul route shall be presumed to be a substantial deviation unless the plan submitter requests that the proposed change be considered a minor deviation in accordance with the procedures set forth in 14 CCR 1036 and 1040 and the Director so determines. The Director shall consult with County Transportation Agency before giving approval.

(e) A statement shall be prepared indicating the proposed type, quantity, purpose and method of application of any chemicals listed as restricted by the State Department of Food and Agriculture that are to be used.

925.5 Tractor Yarding [Santa Clara County]

In addition to 14 CCR 914.2, the following shall apply in Santa Clara County. Prior to submittal of a plan, the location of proposed constructed tractor roads on slopes over 50% shall be intervisibly flagged on the ground.

925.6 Flagging [Santa Clara County]

In addition to other flagging requirements in Subchapter 3 of Title 14 CCR, the Director, where necessary to protect adjoining properties, may require flagging of approximate property lines on the site where any truck road, tractor road or harvest area is proposed within 100 ft. of a property line.

925.7 Log Hauling [Santa Clara County]

(a) Log hauling on public roads is not permitted on Saturdays, Sundays, or on those days which are nationally designated legal holidays, except that such operations shall be permitted to occur on Columbus Day.

(b) Log hauling on public roads may be restricted or not permitted by the Director during commute hours or during school busing hours in order to prevent a serious hazard to traffic flow and safety or to prevent hazardous conditions that would endanger school children.

(c) During log hauling on public roads, the Timber Operator may be required by the Director to post special traffic signs and/or flagmen where determined to be necessary to prevent a hazard to traffic.

(d) Any new access for the use of logging trucks to Highway 17 shall not be constructed until the Director has received approval for such construction from the State Department of Transportation and has consulted with the County Transportation Agency. A request for newly constructed access must be accompanied by evidence that such access will not adversely impact traffic flow and safety on the highway.

925.8 Public Road Buffer Zone [Santa Clara County]

All Logging Roads, tractor roads, and Landings located within 200 ft. as measured along the surface of the ground from the edge of the traveled surface of a public road, shall be screened from direct public view to the extent feasible by leaving trees and vegetation between disturbed areas and public road. If trees are to be harvested in this Buffer Zone, the proposed harvesting shall be identified in the plan and the trees to be cut or left shall be marked before the preharvest inspection, if such an inspection is to be made.

925.9 Public Road Protection [Santa Clara County]

All proposed construction activities for Logging Roads and associated drainage structures, tractor roads, or other activities involving significant earth movement within 200 ft. of a public road shall be described in the plan. The construction of Logging Roads and associated drainage structures, tractor roads, or other activities

CALIFORNIA FOREST PRACTICE RULES

involving significant earth movement within 200 feet of a public road is prohibited if the Director has determined that the activities will significantly increase the maintenance costs of the public road or result in damage to the public road which will significantly restrict the use of the public road.

925.10 Hours of Work [Santa Clara County]

Within 300 ft. of any occupied dwelling, the operation of power equipment except licensed highway vehicles, shall be restricted to the hours between 7:00 a.m. and 7:00 p.m., and shall be prohibited on Saturdays, Sundays and nationally designated legal holidays, except that such operations shall be permitted to occur on Columbus Day. An exception to this rule may be granted by the Director where he/she has found that no disturbance will result to the occupants of the dwelling from the use of such equipment.

925.11 Performance Bonding [Santa Clara County]

When hauling logs pursuant to a THP, the LTO shall provide for the repair of any damage to a county road that is willfully or negligently caused by the LTO's log hauling operations, and shall provide for the repair of any damage caused by the LTO's log hauling operations to appurtenant structures, including, but not limited to, guard rails, signs, traffic signals, culverts, curbs and similar facilities. If necessary to ensure compliance with this section, the county may request, and the Department, upon such request, may require the Timber Operator or responsible party to post adequate financial security to restore paved or unpaved county roads and appurtenant structures which are damaged by log hauling operations. The request for posting of financial security shall be made to the Department during the THP review procedure and no later than five days before the Director's decision date. The Timber Operator or responsible party shall post a certificate of deposit, certificate of insurance or performance bond, or other financial security in favor of the Department in a reasonable amount set by the Director, not to exceed \$5,000 per mile of county road used or \$50,000, whichever is less and subject to provisions of Div. 3, Part I, Chapter 1, Article 8, Sec. 11110 through 11113 of the Gov. C. Such cash deposit or other acceptable financial security shall cover a period not to exceed the effective period of the plan.

When a form of financial security is required, logging trucks shall not use the county roads until the required security is posted with the Department. The Director shall release the bond or equivalent to the principal of the security upon completion of log hauling operations and compliance with the requirements of this section. If and when repairs are necessary, the Director shall request the operator to provide for making the repairs. If the repairs are not made the Department may take corrective action and may order the bond, or equivalent, forfeited in an amount not to exceed actual damage. When a bond or equivalent has been posted, the Department shall provide the county with a copy of the Work Completion Report. The county shall advise the Department in writing within 30 days of its receipt of notification of completion of hauling operations or the Work Completion Report if damage has occurred repairs need to be made. If the county fails to notify the Director within 30 days, the bond of surety shall be released.

926 Santa Cruz County Rules [Santa Cruz County]

In addition to forest practice Rules applying in the Coast Forest District and Southern Subdistrict of the Coast Forest District, Rules contained in 926.1. through 926.19 shall apply within the boundaries of Santa Cruz County. Where the general Rules conflict with Santa Cruz County Rules, the Santa Cruz County Rules shall apply.

926.1 Registered Professional Forester (RPF) Advice [Santa Cruz County]

The provisions of 14 CCR § 913.8(a)(2)(E) shall apply when Timber Operations are conducted in accordance with 14 CCR § 926.25.

926.2 Field Review and Timber Operator Certification [Santa Cruz County]

Subsequent to plan approval, but prior to commencement of Timber Operations, the RPF responsible for preparing the plan, the RPF who will advise the Timber Operator during Timber Operations (if different), and the Timber Operator shall meet in the field to review the specifics of the plan. The Director may attend and participate in such meeting, and shall be given advance notice of the meeting by the plan submitter. After such meeting and prior to commencement of Timber Operations, or upon the filing of any subsequent

CALIFORNIA FOREST PRACTICE RULES

major amendment to the plan, the licensed Timber Operator shall execute and file with the Department a written certification that such Timber Operator or a supervised designee familiar with on-site conditions actively participated in a field review, is familiar with all state and local Rules applicable to the proposed timber operation including without limitation the requirements of Section 1035.2 and 1035.3, understands the plan or such major amendment and each of the conditions that have been placed upon the plan or such major amendment by the Department as part of the review process, and is familiar with, and acknowledges the responsibility to communicate this information to those persons hired to carry out the proposed timber operation under his/her direction. The term "supervised designee" means any representative whose activities are controlled by the LTO in the same manner that an RPF would control the activities of a "supervised designee" as defined in 14 CCR 895.1.

926.3 Plan Submittal and Notice of Intent [Santa Cruz County]

14 CCR 1032.7, subsections (c), (e), (f), and (g), shall not apply in Santa Cruz County. In lieu of those subsections, the following shall apply:

(a) The plan submitter shall prepare and submit to the Director, with the plan, a Notice of Intent to Harvest Timber as described in 14 CCR 1032.7(d) which shall additionally include the following:

(1) A statement that the approximate property lines have been flagged for review where truck roads, tractor roads or harvest areas are within 100 feet of the property line.

(2) In the event helicopter Yarding is proposed, the Notice of Intent will include a map that clearly identifies the areas within the proposed timber harvest plan area that are proposed for helicopter operations, including helicopter log Landing and service area sites and a statement about the approximate duration of helicopter Yarding activities.

(b) The plan submitter shall furnish to the Department at the time of submission of the Plan, the names and addresses of all property owners within 300 ft. of the exterior boundaries of assessor's parcels upon which a plan has been submitted, the names and addresses of property owners with property fronting or bordering that portion of the haul route lying between the plan area and the nearest public road, and the addresses of all private road association members. "Private road association" as used in this section and all other Rules specific to Santa Cruz County shall mean those road associations appearing on a list maintained by the County and provided to the Director which are either a County Service Area which maintains any private road or any other private road association that has recorded by-laws or other organizing instruments recorded in the official records of Santa Cruz County from which it can be ascertained the assessor parcel numbers of the properties owned by the members. If helicopter Yarding is proposed, the list shall also include the names and addresses of property owners with property located within three thousand (3,000) feet of any location in the proposed timber harvest area in which logs are to be picked up, carried, or landed, or helicopters are to use for servicing. It is the intent of the notice provisions of this paragraph to direct the notice to both owners and residents of properties lying within the 3,000 foot notice area; accordingly if any property owner to be noticed by mail on a proposed helicopter Yarding has a mailing address located outside of the three thousand foot notice area and such property owner's property within such area has a street address within such area, the list shall also contain the street address of the property within the three thousand (3,000) foot radius, and shall list the addressee at such property as "Occupant." The list shall be compiled from the latest equalized assessment roll of the county or a list provided by a title insurance company. Any list prepared for noticing an operation with helicopter Yarding shall be deemed accurate provided that it contains accurate information regarding at least 95% of the property owners and situs addresses entitled to notice under these Rules based upon the County Tax Assessor's records.

(c) The plan submitter shall mail copies of the Notice of Intent to all property owners and members of those private road associations on the list provided by the County identified pursuant to (b) at least 10 days prior to plan submission and at this time shall post a copy of the Notice of Intent including a map as described in 14 CCR 1032.7 (d)(8) at a conspicuous location on the private road where a majority of the road association members can view the notice and, if helicopter Yarding is proposed, at a minimum of one conspicuous location every half mile on all public roads within a 2 mile radius of the proposed area of operations. The posted Notice of Intent shall be on colored paper or identified with colored flagging so as to be easily visible to the public. The plan submitter shall further mail the Notice of Intent to:

(1) All members of the Board of Supervisors in whose district any timber operation is proposed;

CALIFORNIA FOREST PRACTICE RULES

(2) The local school district;

(3) Any local publicly-owned water district or community water system which maintains any water production or water storage facility downstream from any location within which any timber operation is proposed. At the time of plan submission, the plan submitter shall certify to the Director in writing that this procedure has been followed.

(d) The plan submitter shall have the Notice of Intent published in a newspaper of general circulation in the area, concurrently with the submission of the plan to the Director. Proof of publication of notice shall be provided to the Director prior to his/her determination made pursuant to 14 CCR § 1037.4.

(e) For plan amendments, the submitter of the amendment shall certify in writing at the time the amendment is submitted that copies of a new Notice of Intent have been mailed to:

(1) All property owners not previously noticed under subsection (b) who, because of the plan amendment, would be required to receive the notice provided in subsection (b).

(2) All property owners previously noticed under subsection (b) when there is a change in silvicultural method.

(f) The plan submitter shall include with the mailed Notice of Intent sent to the persons identified above, other than members of the Board of Supervisors, local school district or publicly-owned water district or community water systems, any available printed general informational material that has been jointly approved by the County of Santa Cruz and the Department, describing the review process and the rights of adjacent landowners and other neighbors under applicable Rules, ordinances or statutes.

(g) The RPF shall simultaneously file with the Department any notice of deviation given to the plan submitter or landowner required under Public Resources Code section 4583.2.

(h) In the event the Director shall approve a timber harvest plan which provides in whole or in part for helicopter Yarding and where such harvest operations are not commenced within the same harvest season in which the plan is approved, the plan submitter shall, not less than 14 days prior to the estimated commencement of helicopter operations and not more than 28 days prior to the estimated commencement of such operations:

(1) Mail a notice to all persons previously notified of the Notice of Intent of the original application or any amendment under (b) above, providing notice of the fact that the helicopter Yarding was approved, containing a map showing the location of the harvest areas, Landing area, and service area approved in the Plan, the hours of operation, the estimated starting date of helicopter Yarding activities, the estimated completion date, and any conditions placed on the helicopter Yarding activity by the Director as part of the approval; and

(2) Post a copy of the notice at a minimum of one conspicuous location every half mile on all public roads within a 2 mile radius of the proposed area of operations. The posted notice shall be on colored paper or identified with colored flagging so as to be easily visible to the public.

(3) The plan submitter shall further mail the notice to those persons identified in 14 CCR 926.3(c)(1) and (2).

(4) Prior to commencement of helicopter operations, the plan submitter shall certify to the Director in writing that these procedures have been followed.

926.4 Preharvest Inspection Report [Santa Cruz County]

Following any preharvest inspection, the Forest Practice Officer who conducted the inspection shall make a written report on the plan, indicating whether the plan, as proposed, conforms to the requirements of the Forest Practice Act and Board Rules, and further stating whether the feasibility analysis required by 14 CCR 898 has properly responded to the issues identified in that section. A copy of this Preharvest Inspection Report shall be provided to review team members and advisors, and shall be made available for public information as a public record.

926.5 Additional Information After Preharvest Inspection [Santa Cruz County]

When the Director determines, based upon field inspection of the plan area, that additional information is necessary in order that the Review Team may conduct the review prescribed by 14 CCR 1037.5(b), the RPF who prepared the plan shall be responsible for supplying such additional information. Additional information shall be limited to information regarding those items specified in 14 CCR 1034, Contents of

CALIFORNIA FOREST PRACTICE RULES

Plan.

926.6 Public Water Agency Representative [Santa Cruz County]

In the case of any timber operation proposed to be carried out in an area which serves as a watershed for any publicly-owned water purveyor, the Director shall request a representative of such water purveyor to assist the Department as an advisor in the review process, pursuant to the provisions of 14 CCR 1037.5; such water purveyor representative shall be permitted to participate in all review team meetings.

926.7 Review Team Field Review [Santa Cruz County]

Any review team member may, on request, accompany the Department as an advisor to the Department, on any field review the Department conducts prior to approval of the plan. A member of the review team shall have five working days following the date of the review team meeting in which to file any notice of non-concurrence provided for in 14 CCR 1037.5(e).

When a proposed timber harvest area is adjacent to a residential neighborhood; when the only access to the proposed timber harvest area is through neighboring property; or when multi-owner private road(s) are to be used for hauling; the residents of the adjacent neighborhood or the owners of the private road(s) may designate one person as their representative to attend the pre-harvest inspection and all Review Team field inspections and meetings that are scheduled. The Director and plan submitter shall be provided with written notice of the designated representative's name, address and telephone number. Such person may only enter the property of the landowner where the harvest is proposed with the consent of the landowner. Such person shall be entitled to receive advance notice of the time and place of the pre-harvest inspection and Review Team field reviews, may make inquiries of the review team members, but shall not be a member of the Review Team.

926.8 Fuelwood Operations [Santa Cruz County]

Notwithstanding 14 CCR 1038(b), the harvest of fuelwood in operations where more than three (3) acres are proposed to be harvested, shall be carried out in accordance with the provisions of 14 CCR 1038-1038.1. In addition, for purposes of 14 CCR 1038, minimum Impact means:

- (a) No new road construction;
- (b) No road reconstruction that involves substantial change in the original Road Prism;
- (c) No Timber Operations on slopes in excess of sixty (60) percent;
- (d) No Timber Operations in Special Treatment Areas;
- (e) No Timber Operations within Watercourse and Lake Protection Zones;
- (f) No Timber Operations on Unstable Soils;
- (g) No Timber Operations within five hundred (500) feet on an Active Nesting site of rare or endangered bird Species;
- (h) No Timber Operations on areas with high or extreme Erosion Hazard Rating;
- (i) The Harvest Area must be immediately stocked; and
- (j) Timber Operations are limited to forty-five (45) days unless an approved plan is obtained.

Fuelwood operations that cannot be harvested pursuant to 14 CCR 1038 and 1038.1 will require a plan pursuant to 14 CCR 913.8(a)(2).

926.9 Hours of Work [Santa Cruz County]

(a) Except as provided in paragraph (b) below, the operation of chainsaws and other power-driven equipment shall be restricted to the hours between 7:00 a.m. and 7:00 p.m., and shall be prohibited on Saturdays, Sundays, and nationally designated legal holidays, except that such operations shall be permitted to occur on Columbus Day. An exception to this rule may be granted by the Director where s/he has found that no disturbance will result from the use of such equipment.

(b) Within 300 feet of any occupied legal dwelling, the operation of chain saws and all other power equipment, except licensed highway vehicles, shall be restricted to the hours between 8:00 a.m. and 6:00 p.m., and shall be prohibited on Saturdays, Sundays, and nationally designated legal holidays. The

CALIFORNIA FOREST PRACTICE RULES

Director may grant an exception to allow operations between 7:00 a.m. and 7:00 p.m. within 300 feet of residences if a determination of no disturbance can be made based upon the occupant(s) agreement to a written request submitted by the RPF to the Director before plan approval.

(c) When it is anticipated that there will be staging of licensed vehicles outside the plan submitter's property between the hours of 9:00 p.m. and 7:00 a.m., the RPF shall provide an operating plan which reduces noise impacts to nearby residences.

926.10 Log Hauling [Santa Cruz County]

(a) Log hauling on Public Roads is not permitted on Saturdays, Sundays, or on those days which are nationally designated legal holidays, except that such operations shall be permitted to occur on Columbus Day.

(b) Log hauling on Public Roads, or private roads may be restricted or not permitted by the Director during commute hours or during school busing hours when necessary to prevent a serious hazard to traffic flow and safety or to prevent hazardous conditions that would endanger public safety.

(c) During log hauling on Public Roads, or on private roads the Timber Operator may be required by the Director to post special traffic signs and/or flagpersons where determined to be necessary to prevent a hazard to traffic.

926.11 Flagging of Property Lines [Santa Cruz County]

The RPF or his/her supervised designee shall, prior to plan submission to the Department, flag the approximate property lines of the Timberland Owner's parcel on the site where any truck road, tractor road or harvest area is proposed within 100 feet of a property line.

926.12 Soil [Santa Cruz County]

The process of constructing or reconstructing truck roads, tractor roads, tractor trails, and Landings shall not cause soil to be deposited on property owned by others, except with the consent of the property owner.

926.13 Performance Bonding [Santa Cruz County]

When hauling logs pursuant to a THP, the LTO shall provide for the repair of any damage to a county road that is willfully or negligently caused by the LTO's log hauling operations, or to a private road that is caused by the LTO's log hauling operations, and shall provide for the repair of any damage caused by the LTO's log hauling operations to appurtenant structures including, but not limited to, guard rails, signs, traffic signals, culverts, curbs and similar facilities. If necessary to ensure compliance with this section, the county, owner(s)/easement holder(s) of private road or private road association may request, and the Department, upon such request, may require the Timber Operator or responsible party to post adequate financial security to restore paved or unpaved county or private roads and appurtenant structures which are damaged by log hauling operations. The request for posting of financial security shall be made to the Department during the THP review procedure and no later than five days before the Director's decision date. The Timber Operator or responsible party shall post a certificate of deposit, certificate of insurance or performance bond, or other financial security in favor of the Department in a reasonable amount set by the Director, not to exceed \$5,000 per mile of road used or \$50,000, whichever is less and subject to provisions of Division 3, Part I, Chapter 1, Article 8, Sections 11110 through 11113 of the Government Code. Such cash deposit or other acceptable financial security shall cover a period not to exceed the effective period of the plan. When a form of financial security is required, logging trucks shall not use the roads until the required security is posted with the Department. The Director shall release the bond or equivalent to the principal of the security upon completion of log hauling operations and compliance with the requirements of this section. If and when repairs are necessary, the Director shall request the operator to provide for making the repairs. If the repairs are not made, the Department may take corrective action and may order the bond, or equivalent, forfeited in an amount not to exceed actual damage. When a bond or equivalent has been posted, the Department shall provide the county with a copy of the Work Completion Report. The county shall advise the Department in writing within 30 days of its receipt of notification of completion of hauling operations or the Work Completion Report if damage has occurred, repairs need to be made. If the county fails to notify the Director within 30 days, the bond or surety shall be released.

CALIFORNIA FOREST PRACTICE RULES

926.14 Biotic Resources [Santa Cruz County]

In addition to the requirements of 14 CCR 1034(w), the plan shall identify local unique plant and animal species as identified in the Santa Cruz County General Plan.

926.15 Road Construction [Santa Cruz County]

Whenever new road construction is proposed and the plan submitter owns or controls any property contiguous to the parcel or parcels on which Timber Operations are proposed, and such contiguous property contains Timberland, the RPF shall include a map and explanation of how the new road is integrated into the existing or proposed truck road and associated transportation system for all the contiguous property owned or controlled by the plan submitter on which Timberland is found. Such proposed integrated truck road and associated transportation system shall be reviewed in connection with review of the proposed plan, and the plan shall be modified, if necessary, to assure that the approved plan will be compatible and consistent with Timber Operations on the contiguous property.

926.16 Flagging [Santa Cruz County]

The location of proposed truck roads, constructed tractor roads, Landings, and Watercourse crossings shall be designated on the plan map and shall be located in the field with flagging. Such flagging shall occur prior to the preharvest inspection if one is to be conducted. Flagging for truck roads and constructed tractor roads will be intervisible along the proposed alignments.

926.17 Abandonment of Roads and Landings [Santa Cruz County]

When an existing truck road, tractor road, or Landing is located in an area in which it could not be newly constructed in conformance with these Rules, then, where feasible, such road or Landing shall be abandoned, stabilized, revegetated, and restricted from vehicular use, unless the use of such road or Landing would produce less environmental Impact than the use of a new road or Landing constructed in accordance with these Rules.

926.18 Winter Period [Santa Cruz County]

The winter period for Santa Cruz County shall be October 15 through April 15.

926.19 Erosion Control Maintenance [Santa Cruz County]

The plan submitter shall maintain all drainage structures, drainage facilities and gating or other devices to prevent access required by these Rules in effective working condition throughout one winter period after completion of Timber Operations unless other stricter measures are required under the Forest Practice Rules. Skid trails, Landings and work areas shall be reseeded, mulched or protected by compacting Slash and debris from harvest operation. The Director may require further measures to prevent unnecessary damage to road surfaces from unauthorized use and to protect the quality and beneficial uses of water. The County representative responsible for review of timber harvests shall receive advanced notice and may attend the work completion inspection with the Department to review erosion control measures. A work completion report may not be filed until this requirement has been met.

926.23 Contents of Plan [Santa Cruz County]

In addition to 14 CCR 1034 the following shall apply in Santa Cruz County:

- (a) When log hauling is proposed over non-appurtenant private roads, the RPF shall provide:
 - (1) Information substantiating the Timber Owner's legal right to access or use said private road(s).
 - (2) A statement as to the estimated number of total logging truck loads to be removed and the approximate number of haul days and location of proposed logging truck staging areas.
 - (3) A statement as to how obligations to maintain the road shall be satisfied commensurate with use.
 - (4) Specific measures which provide for the safe use of the road, such as flag persons, signage, pilot cars and hours of restriction.
 - (5) Videotape, photograph or other means of documentation for noting the existing conditions of the road.

CALIFORNIA FOREST PRACTICE RULES

(b) The RPF shall provide a map showing the location of the flagged property boundaries along with any documentation that substantiates the property line.

(c) The description of the plan area shall include the County Assessor Parcel Number(s) for those parcel(s) within which Timber Operations are to be conducted.

(d) The RPF shall include within the notice to the landowner section of the plan the following statement: "Section 16.22.030 of the County Code states that any road or bridge constructed pursuant to a Timber Harvest Permit [*sic: Plan*] issued by the State of California, if used to serve purposes other than forest management activities shall be considered new and shall be subject to all County design standards and applicable policies including County grading and bridge permits."

926.25 Special Harvesting Methods [Santa Cruz County]

In addition to 14 CCR 913.8 subsection (a)(1), the harvesting limitation, re-entry period and leave tree standards shall be modified as follows:

(a) The cutting standards are as follows:

(1) For areas where the proposed harvest rate is fifty-one to sixty (51-60) percent of the trees greater than eighteen (18) inches d.b.h., the minimum re-entry period shall be fourteen (14) years.

(2) For areas where the proposed harvest is fifty (50) percent or less of the trees greater than eighteen (18) inches d.b.h., a ten (10) year re-entry period shall apply.

(3) Regardless of re-entry period, no more than forty (40) percent of the trees greater than fourteen (14) inches and less than eighteen (18) inches d.b.h. shall be harvested.

927 Marin County Rules [Marin County]

In addition to forest practice Rules applying in the Coast Forest District and Southern subdistrict of the Coast Forest District, Rules contained in 927.1 through 927.17 shall apply within the boundaries of Marin County. Where the general Rules conflict with Marin County Rules, the Marin County Rules shall apply.

927.1 Winter Period [Marin County]

The winter period for Marin County shall be October 1 through April 15.

927.2 Contents of Plan [Marin County]

All of subsections (x)(1) through (x)(14) of 14 CCR 1034 shall apply in Marin County. Subsection (g) and that portion of (x) pertaining to map size shall not apply and in lieu of those subsections, the following shall apply:

(a) A description of the plan area within which Timber Operations are to be conducted. The description shall include the following:

(1) U.S. Geological Survey (USGS) Quadrangle name(s) and date(s),

(2) township, range, and section number(s),

(3) county name(s),

(4) CALWATER 2.2 planning watershed number(s),

(5) approximate acreage, and

(6) assessor's parcel number(s) for the assessor's parcels within which a plan is submitted.

(b) The estimated number of logging truck loads to be removed and the approximate number of daily trips.

(c) The following information shall be clearly provided on a reproducible 1"=500' topographic map showing 40 ft. contour intervals, provided such maps are available from the county at nominal cost. (Nominal cost for the purposes of this subsection shall not exceed \$10.) If this map is not available, the map requirement in 14 CCR 1034(x) shall apply. Additional maps may be required to show specific details, and may be planimetric. Color coding shall not be used. A legend shall be included indicating the meaning of the symbols used. See district Rules for the appropriate minimum mapping acreage.

(1) Location of Marin County Recreation Corridor (CRC), scenic corridors, conservation zones, as identified in the Marin Countywide Plan of April, 1982 and s designated by the County General Plan of 1982 or in any other document officially adopted by the county.

(2) Location of all structures (including mobile homes or trailers) currently maintained for human

CALIFORNIA FOREST PRACTICE RULES

habitation within 200 ft. as measured along the surface of the ground from the boundary of the plan area.

(d) On Timber Operations requiring submission of a plan, all routes to be used for removing forest products from the plan area to the mill or county line shall be shown on a road map submitted with the plan. A proposed change in the use of public roads that are part of the haul route shall be presumed to be a substantial deviation unless the plan submitter requests that the proposed change be considered a minor deviation in accordance with the procedure set forth in 14 CCR 1036 and 1040 and the Director so determines. The Director shall consult with County Transportation District before giving approval. The plan shall identify the location of schools along the haul route and shall specify their hours of operation.

(e) Plan maps must show the location of and identify the following: all log Landings proposed to be used, and all main tractor roads on slopes over 50%, all Logging Roads, all Watercourses, lakes, and marshes and boundaries of the CRC within or contiguous to the plan area.

(f) A statement shall be prepared indicting the proposed type, quantity, purpose and method of application of any chemicals listed as restricted by the State Department of Food and Agriculture that are to be used.

(g) The plan shall include a brief statement describing any additional proposed uses for the land in addition to timber harvesting (e.g., a residential or commercial development) for a period of five years.

(h) Whenever new road construction is proposed and the plan submitter owns or controls any property contiguous to the parcel or parcels on which Timber Operations are proposed, and such contiguous property contains Timberland, the RPF shall include a map and explanation of how the new road is integrated into the existing or proposed truck road and associated transportation system, for all the contiguous property owned or controlled by the plan submitter on which Timberland is found. Such proposed integrated truck road and associated transportation system shall be reviewed in connection with review of the proposed plan, and the plan shall be modified, if necessary, to assure that the approved plan will be compatible and consistent with Timber Operations on the contiguous property.

(i) The THP shall include a plan for safe access to a public roadway from the site of operations. The plan submitter shall be required to consult with County officials in designing the access plan, and shall attach to the THP a County encroachment permit if one has been approved.

(j) The plan submitter shall identify any publicly owned water purveyor within the drainage and indicate on the plan whether a watershed protection agreement with any publicly owned water purveyor has been obtained for the proposed operation and append any such agreement to the plan. Any such agreement shall be appended for information purposes only. If no such agreement has been reached with the water purveyor, the plan submitter shall attach any previous correspondence to and from the water purveyor concerning the proposed timber operation.

(k) If a road or Landing to be constructed or improved as part of the proposed timber operation is planned to be used to serve or facilitate a residential or commercial development, the plan submitter shall obtain a grading permit from the county and attach any such permit to the plan, for information purposes only.

927.3 Tractor Yarding [Marin County]

In addition to 14 CCR 914.2, the following shall apply in Marin County: Prior to submittal of a plan, the approximate location of proposed constructed tractor roads on slopes over 50% shall be intervisibly flagged on the ground.

927.4 Flagging [Marin County]

In addition to flagging requirements in Subchapter 3 of Title 14 CCR, the Director, where necessary to protect adjoining properties, may require flagging of approximate property lines on the site where any truck road, tractor road or harvest area is proposed within 100 ft of a property line.

927.5 Log Hauling [Marin County]

(a) Log hauling on public roads is not permitted on Saturdays, Sundays, or on those days which are nationally designated holidays, except that such operations shall be permitted to occur on Columbus Day.

(b) Log hauling on public roads shall be restricted or not permitted by the Director during commute hours or during school busing hours if necessary to prevent a significant hazard to traffic flow and safety or to prevent hazardous conditions that would endanger public safety.

(c) During log hauling on public roads, the Timber Operator may be required by the Director to post

CALIFORNIA FOREST PRACTICE RULES

special traffic signs and/or flagpersons where determined to be necessary to prevent a hazard to traffic.

(d) Any new access for the use of logging trucks on Highway 1 shall not be constructed until the Director has received approval for such construction from the State Department of Transportation and has consulted with the County Transportation District. A request for newly constructed access must be accompanied by evidence that such access will not adversely affect traffic flow and safety on the highway.

(e) Where road width will not permit passage of a logging truck and another oncoming vehicle, and adequate turnouts are not present, the Director may require the use of pilot cars equipped with warning signs and flashing lights to guide logging trucks on public roads.

(f) Within 300 ft. of any occupied dwelling, the operation of power equipment, including chain saws, except licensed highway vehicles, shall be restricted to the hours between 7:00 a.m. and 7:00 p.m., and shall be prohibited on Saturdays, Sundays, and nationally designated legal holidays. Where, because of unusual ground condition or very close proximity of occupied dwellings or special circumstances related thereto, the Director determines that a need exists for further restrictions, he/she may increase the distance and may limit the hours to not less than 8:00 a.m. to 5:00 p.m. An exception to this rule may be granted by the Director where he/she has found that no disturbance will result to the occupants of the dwelling from the use of such equipment.

927.6 Public Road Buffer Zone [Marin County]

All Logging Roads, tractor roads, and Landings located within 200 ft., as measured along the surface of the ground from the edge of the traveled surface of a public road, shall be screened from direct public view to the extent feasible by leaving trees and vegetation between disturbed areas and public roads. If trees are to be harvested in this Buffer Zone, the proposed harvesting shall be identified in the plan and the trees to be cut or left shall be marked before the preharvest inspection, if such an inspection is to be made.

927.7 Timber Harvesting Plans [Marin County]

(a) An initial inspection of the area in which Timber Operations are to be conducted shall be made within 10 days from the date of filing of the plan, or such longer period as may be mutually agreed upon by the Director and the person submitting the plan. The RPF who prepared the plan shall attend the initial inspection.

(b) In the case of any timber operation proposed to be carried out in an area which serves as a watershed for any publicly owned water purveyor, the Director shall request a representative of such water purveyor to assist the Department as an advisor in the review process, pursuant to the provision of 14 CCR 1037.5; such water purveyor representative shall be permitted to participate in all review team meetings.

927.8 Exemptions from Timber Harvesting Plan Requirements [Marin County]

To ensure that the protection necessary to maintain the integrity of the resources of the County are achieved, the following requirements shall apply to the Timber Operations exempt from filing of THPs under 14 CCR 1038:

(a) The requirements of 14 CCR 927.7(a) and (b), and 927.2(c) and (e) shall apply with the following exceptions:

(1) Pursuant to PRC 4582.7, an initial inspection may not be required;

(2) A written plan is not required although a plan map must accompany the notice of Timber Operations. Harvesting of Christmas trees is exempt from timber marking requirements.

(b) The expected dates of commencement and completion shall be stated in the notice of Timber Operations.

(c) The Director shall acknowledge in writing and within 10 days, acceptance or rejection of the notice of Timber Operations. The Director shall consult with the Marin County Planning Director before acceptance. Timber Operations shall not commence until the Director's acceptance has been received by the person who filed the notice.

(d) Exempt operations shall be limited to the calendar year of acceptance.

(e) The requirements of PRC 4585, Completion Report, and PRC 4587, Stocking Reports, shall apply to exempt operations within the County.

CALIFORNIA FOREST PRACTICE RULES

927.9 Silvicultural Methods and Intermediate Treatments [Marin County]

The objective of this section is to prescribe silvicultural methods and treatments that will protect the long-term productivity of soils and Timberlands and protect the natural and scenic qualities of the County. The following silvicultural methods and treatments as prescribed below will be applied in the County. 14 CCR 913 through 913.6 defines these methods and treatments.

(a) Commercial Thinning Intermediate Treatment or the Selection Method: When the commercial thinning treatment or the selection silvicultural method is used, the following standards are required:

(1) Leave a well distributed timber stand after cutting and logging operations have been completed on the cut area. Leave at least forty (40) percent by number of those trees eighteen (18) inches or more d.b.h. which were present prior to commencement of current Timber Operations and at least fifty (50) percent by number of those over twelve (12) inches d.b.h. but less than eighteen (18) inches or more d.b.h. Leave trees eighteen (18) inches or more d.b.h. shall be Dominant or Co-dominant in crown class prior to timber harvesting or have crowns typical of such Dominant or Co-dominant trees. All leave trees shall be thrifty coniferous trees which are free from substantial damage caused by Timber Operations. No conifer tree shall be cut which is more than seventy-five (75) feet from the nearest leave tree twelve (12) inches d.b.h. or larger located within the logging area.

(2) Immediately following completion of Timber Operations, Stocking must meet or exceed Stocking Standards of 14 CCR § 913.8.

(3) A report of Stocking as described in PRC § 4587 shall be filed within six (6) months following completion of work as described in the Plan.

(b) Sanitation-Salvage Treatment: When the sanitation-salvage treatment is used, the following practices are required:

(1) Restrictions on time periods for subsequent Timber Operations shall not apply to the sanitation-salvage treatment.

(2) An effort shall be made to regenerate any cut area during the first planting season following log removal. Necessary site preparation, planting, or seeding shall be completed within the first planting season following logging, except where unusual or adverse weather conditions require extending site preparation and planting into the following planting season. Deficiencies in Stocking shall be corrected by planting annually at least three (3) times if necessary to meet the Stocking Standards in 14 CCR § 913.8.

(c) Clearcutting Method: The clearcutting method is not authorized for the County.

(d) Recutting of Logging Areas. Timber Operations for removal of trees may only be repeated on a Logging Area within less than ten (10) years after completion of a previous Timber Operation if minimum standards have been met, the reasons for the operation are justified and explained in the Plan, and the scenic and/or natural qualities of a stand would be enhanced by lighter or more frequent tree removal. In no instance shall Stocking be reduced below the standards provided in 14 CCR § 913.8 nor shall more than sixty (60) percent by numbers of those trees eighteen (18) inches and more d.b.h. and no more than fifty (50) percent by numbers of those trees over twelve (12) inches d.b.h. but less than eighteen (18) inches d.b.h. be removed within any one ten (10) year period.

(e) On Timber Operations in which cutting has occurred within ten (10) years preceding the current operations, stumps which are the result of cutting trees within the preceding ten (10) years shall be counted as trees cut during the current operation in determining percent of trees cut. Timber Operations conducted under the Sanitation-Salvage Treatment, and the harvesting of minor forest products and incidental vegetation are exempt from the above provision of this section.

927.10 Stocking Requirements [Marin County]

The Stocking Standards for understocked Timberlands and Substantially Damaged Timberlands as provided for by 14 CCR 1080 through 1081.1 and 1085 through 1085.6 are not applicable in the County.

927.11 Logging Practices [Marin County]

The following logging practices shall be adhered to:

(a) Roads: Rules contained in 14 CCR 923 through 923.2 shall be adhered to with the following special requirements:

(1) Roads shall be single lane, and generally the traveled surface shall be no more than 12 ft. in

CALIFORNIA FOREST PRACTICE RULES

width, except where alignment, safety, and equipment necessary to conduct the operation requires additional width. Deviations shall be explained and justified in the plan.

(2) Roads, Landings, cuts, and fills shall be screened from direct view to the extent feasible by leaving screen trees and other vegetation between the disturbed areas and public areas utilized by substantial numbers of viewers.

(b) Soil disturbance, other than that incidental to necessary road maintenance, whether with tractor or by cable means, shall not occur under excessively wet ground conditions that could result in substantial soil compaction and erosion.

(c) Notwithstanding the requirements of 14 CCR 1040, if in construction rock outcroppings, springs, and other physical factors require a change in roads, Landings, and tractor road locations, the location can be changed with the concurrence of the RPF, the operator, and the Director's representative, provided that such changes in location constitute minor deviations. The RPF shall provide written confirmation of such minor deviations which shall become a part of the plan. All changes in location constituting substantial deviations shall be submitted to the Director as amendments to the plan.

(d) Felling Practices: Up to 10% of the trees that are proposed for cutting may be substituted one for one with those proposed to be left uncut provided that the leave tree proportion, size class, distribution, and general forest appearance of the residual stand as approved in the preliminary field work is preserved. Justification for the substitution standard shall be based on unavoidable tree damage, safety factors, lean of trees, location of obstructions or roads or openings insufficient to accommodate felled trees.

(e) The process of constructing or reconstructing truck roads, tractor roads, and Landings shall not cause soil to be deposited on property owned by others, except with the consent of the property owner.

(f) The plan submitter shall maintain all drainage structures and drainage facilities required by these Rules in effective working condition throughout one winter period after completion of Timber Operations. A work completion report may not be filed until this requirement has been met.

927.12 Hazard Reduction [Marin County]

(a) Burning: Broadcast Burning shall be prohibited on lands harvested under the commercial thinning treatment and selection silvicultural methods in the County. Broadcast Burning may be allowed for Site Preparation purposes in accordance with 14 CCR § 917.4 on lands harvested under the sanitation-salvage treatment when a prescribed burning plan is submitted as part of the THP which explains and justifies Broadcast Burning in the County. An effort shall be made to protect the surface organic horizon of the soil during the course of any permitted Broadcast Burning operations.

(b) Snags: All snags within the WLPZ and within 100 ft. of meadow edges shall be left standing with the following exceptions:

(1) When felling is required for fire or safety reasons (CAL-OSHA CCR § 6259) or when necessary in sanitation-salvage operations.

(2) When a snag of commercial value is marked for felling by the RPF after an initial preharvest inspection and consultation with the CDFW and the Timber Owner.

927.13 Buffer Zones Within the CRC [Marin County]

The following additional Rules shall apply to Buffer Zones within Marin County Recreation Corridor:

The Buffer Zone adjacent to designated coastal highways shall be a 200 ft. wide band running parallel to the first line of trees nearest the road on appropriate side(s) of the road as designated. In no place shall the Buffer Zone extend more than 350 ft. from the shoulder of the road.

A Buffer Zone of 200 ft. shall also run adjacent to all publicly owned preserves and recreation areas including national, state, regional, county, and municipal parks. Said distance shall be measured along the surface of the ground.

Logging Roads, tractor roads, and skid trails and Landings shall be screened from direct view to the extent feasible by leaving trees and vegetation between the disturbed area and vista points that would attract viewers.

927.14 Notice of Intent and Filing [Marin County]

In addition to 14 CCR 924.1(b) and 924.4(b) the Notice of Intent and Filing of THP applications shall be

CALIFORNIA FOREST PRACTICE RULES

provided to the appropriate publicly owned water purveyor and to any school district or private school on the haul route excluding those portions of Highway 101.

927.15 Review Team Meetings [Marin County]

In addition to 14 CCR 1037.5, the following provisions shall govern public participation in the review of timber harvesting plans in Marin County:

(a) A written response by the Department and Fire Protection to issues raised that are pertinent to the THP in question shall be made available to the public before the final approval or disapproval of the THP. The issues raised must be received by the Department before the date for decision on the THP and may be either oral or written.

(b) Review team recommendations shall be made available at the CAL FIRE or county planning department office for public comment prior to the final decision.

(c) Any review team member and any qualified technical expert designated by a review team member may, on request, accompany the Department as an advisor to the Department, on any field review the Department conducts prior to approval of the plan.

927.16 Registered Professional Forester (RPF) Advice [Marin County]

The provisions of 14 CCR § 913.8(a)(2)(E) shall apply when Timber Operations are conducted in Marin County.

927.17 Decisions on Winter Operations [Marin County]

The Director may prohibit any activity in the winter period that presents an unacceptable risk of significant degradation to the soil and water resources.

928 San Mateo County Rules [San Mateo County]

In addition to forest practice Rules applying in the Coast Forest District and Southern subdistrict of the Coast Forest District, Rules contained in 928.1 through 928.8 shall apply within the boundaries of San Mateo County. Where the general Rules conflict with San Mateo County Rules, the San Mateo County Rules shall apply.

928.1 Definitions [San Mateo County]

The following definitions shall apply in San Mateo County:

(a) "Haul Route" means all routes to be used for removing forest products from the plan area to the mill or county line.

(b) "Encroachment" means any point at which logging trucks enter onto or exit from a public road, whether the encroachment is newly constructed or not.

928.2 Contents of Plan [San Mateo County]

In addition to 14 CCR 1034, the following shall apply:

(a) The estimated number of logging truck loads to be removed and the approximate number of daily trips.

(b) In addition to 14 CCR 1034(x), the following information shall be clearly provided on the map:

(1) The location of scenic roads as designated by the County General Plan or in any other document officially adopted by the county.

(2) Location of all structures (including mobile homes or trailers) currently maintained for human habitation within 200 ft. as measured along the surface of the ground from the boundary of the plan area.

(3) Location of existing and proposed firebreaks.

(c) On Timber Operations requiring submission of a plan, all routes and encroachments onto county roads to be used for removing forest products from the plan area to the mill or county line shall be shown on a road map submitted with the plan. The Director shall consult with the county Transportation Agency before giving approval.

CALIFORNIA FOREST PRACTICE RULES

928.3 Flagging [San Mateo County]

(a) In addition to 14 CCR 914.2, the following shall apply in San Mateo County:

Prior to submittal of a plan, the approximate location of proposed constructed tractor roads on slopes over 50% shall be intervisibly flagged on the ground.

(b) In addition to other flagging requirements in Subchapter 3 of Title 14 CCR, the Director, where necessary to protect adjoining properties, shall require flagging of approximate property lines on the site where any truck road, tractor road or harvest area is proposed within 100 ft. of a property line, unless explained and justified in the plan and approved by the Director.

928.4 Performance Bonding [San Mateo County]

When hauling logs pursuant to a THP, the LTO shall provide for the repair of any damage to a county road that is willfully or negligently caused by the LTO's log hauling operations, and shall provide for the repair of any damage caused by the LTO's log hauling operations to appurtenant structures, including, but not limited to, guard rails, signs, traffic signals, culverts, curbs and similar facilities. If necessary to ensure compliance with this section, the county may request, and the Department, upon such request, may require the Timber Operator or responsible party to post adequate financial security to restore paved or unpaved county roads and appurtenant structures which are damaged by log hauling operations. The request for posting of financial security shall be made to the Department during the THP review procedure and no later than five days before the Director's decision date. The Timber Operator or responsible party shall post a certificate of deposit, certificate of insurance or performance bond, or other financial security in favor of the Department in a reasonable amount set by the Director, not to exceed \$5,000 per mile of county road used or \$50,000, whichever is less and subject to provisions of Div. 3, Part I, Chapter 1, Article 8, Sec. 11110 through 11113 of the Gov. C. Such cash deposit or other acceptable financial security shall cover a period not to exceed the effective period of the plan.

When a form of financial security is required, logging trucks shall not use the county roads until the required security is posted with the Department. The Director shall release the bond or equivalent to the principal of the security upon completion of log hauling operations and compliance with the requirements of this section. If and when repairs are necessary, the Director shall request the operator to provide for making the repairs. If the repairs are not made the Department may take corrective action and may order the bond, or equivalent, forfeited in an amount not to exceed actual damage. When a bond or equivalent has been posted, the Department shall provide the county with a copy of the Work Completion Report. The county shall advise the Department in writing within 30 days of its receipt of notification of completion of hauling operations or the Work Completion Report if damage has occurred repairs need to be made. If the county fails to notify the Director within 30 days, the bond of surety shall be released.

928.5 Hours of Work [San Mateo County]

Within 300 feet of any occupied dwelling, the operation of power equipment, including chain saws, except licensed highway vehicles, shall be restricted to the hours between 7:00 a.m. and 7:00 p.m., and shall be prohibited on Saturdays, Sundays, and nationally designated legal holidays, except that such operations shall be permitted to occur on Columbus Day. Where, because of unusual ground conditions or very close proximity of occupied dwellings or special circumstances related thereto, the Director determines that a need exists for further restrictions, he/she may increase the distance and may limit the hours to not less than 8:00 a.m. to 5:00 p.m. An exception to this rule may be granted by the Director where he/she has found that no disturbance will result to the occupants of the dwelling from the use of such equipment.

928.6 Log Hauling [San Mateo County]

(a) Log hauling on Public Roads is not permitted on Saturdays, Sundays, or on those days which are nationally designated legal holidays, except that such operations shall be permitted to occur on Columbus Day.

(b) Log hauling on Public Roads may be restricted or not permitted by the Director during commute hours or during school busing hours in order to prevent a serious hazard to traffic flow and safety or to prevent hazardous conditions that would endanger public safety.

(c) During log hauling on Public Roads, the Timber Operator may be required by the Director to post

CALIFORNIA FOREST PRACTICE RULES

special traffic signs and/or flagpersons where determined to be necessary to prevent a hazard to traffic.

(d) Where road width will not permit passage of a logging truck and another oncoming vehicle, and adequate turnouts are not present, the Director may require the use of pilot cars equipped with warning signs and flashing lights to guide trucks on Public Roads.

928.7 Cutting Practices [San Mateo County]

(a) Prior to submission of the plan to the Director, all timber proposed for harvest shall be clearly marked with paint at points approximately 4 1/2 feet above the ground and at ground level, except where the Director believes that a sample marking of 20% of the area up to a maximum of five acres would be adequate for plan evaluation.

(b) Where a sample marking has been used, the balance of the timber to be cut, except for hardwoods, shall be marked under the direct supervision of the Forester (RPF) who prepared the plan prior to the time of cutting.

(c) Up to 10% of the trees that are proposed for cutting may be substituted one for one with those proposed to be left uncut provided that the leave tree proportion, size class, distribution and general forest appearance of the residual stand as approved in the preliminary field work is preserved.

Justification for the substitution standard shall be based on unavoidable tree damage, safety factors, lean of trees, location of obstructions or roads or openings insufficient to accommodate felled trees.

COUNTY RULES, NORTHERN DISTRICT

945 Lake County Rules [Lake County]

In addition to forest practice Rules applying in the Northern Forest District, these Rules shall apply within the areas of Lake County designated as Scenic Combining District except as provided by subsection (f) of Public Resources Code section 4516.5. Where the general Rules conflict with the Lake County Rules, the Lake County Rules shall apply.

945.1 Statement of Purpose [Lake County]

The purpose of these Rules is to:

(a) ensure that the visual and aesthetic sites identified within the Scenic Combining District are adequately identified and protected,

(b) provide direction to RPFs preparing Plans which, for the purposes of this section, include THPs, MTHPs, NTMPs, WFMPs, PTEIRs, Notices of Emergency Timber Operations, and any Exemptions Notices pursuant to 14 CCR §§ 1038 and 1104.1,

(c) provide direction to the Timber Operator conducting Timber Operations,

(d) provide direction to the Department in its review, approval, and inspection programs.

945.2 Definitions [Lake County]

"Scenic Combining District" means a zone of varying widths adjacent to county and state maintained roadways and certain state and county roads as adopted by county ordinance. The Scenic Combining District is administered by the Community Development Department of Lake County.

Scenic Combining District width is measured from the edge of the roadway and may extend on both sides of the road. The width of the Scenic Combining District is identified, mapped, and administered by the Community Development Department.

945.3 Timber Harvest Prescriptions [Lake County]

The following Rules shall be applied to all areas designated Scenic Combining District. Limited timber harvesting may be allowed within the Scenic Combining Districts using the following criteria:

(a) Selection. In the areas designated as Scenic Combining Districts, only the selection regeneration method and commercial thinning shall be used. The group selection method (14 CCR § 933.2(a)(2)(B)) shall not be used.

(1) A map that clearly defines the location and extent of the Scenic Combining District occurring on

CALIFORNIA FOREST PRACTICE RULES

the site to be harvested shall be submitted with the Plan.

(2) Trees to be harvested shall be marked by or under the supervision of an RPF. All trees to be harvested shall be marked within the Scenic Combining District prior to a preharvest inspection for evaluation.

(3) In all areas designated as Scenic Combining Districts, at least 75 square feet per acre of conifer basal area shall be retained.

(4) Post harvest stand stocking levels of conifers shall be stated in the Plan. The level of residual stocking shall be consistent with maximum sustained production for high quality timber products. In no case shall conifer stocking levels per acre be reduced below the following standards:

(A) Within the first 150 feet of the Scenic Combining District, at least 50% of the trees 18 to 24 inches dbh, and 50% of the trees 26 inches dbh and larger, shall be retained.

(B) Between 150 and 300 feet of the Scenic Combining District, at least 50% of the trees less than 18 inches dbh, 40% of the trees 18 - 24 inches dbh, and 33% of the trees 26 inches dbh and larger shall be retained.

(C) Between 300 feet and the outermost boundary of the Scenic Combining District, 75 square feet of Basal Area Per Acre shall be retained.

(b) Logging Roads, tractor roads, and Landings shall be screened from direct view to the extent feasible by leaving trees and vegetation between the disturbed areas and vista points that would attract viewers.

(c) Hardwoods shall be considered for the purposes of aesthetic enhancement and a minimum of 25% of the pre-harvest hardwood basal area shall be retained.

(d) A second harvest shall not be conducted sooner than ten years following completion of an initial harvest unless an emergency condition exists pursuant to 14 CCR § 1052 *et seq.* in the interim, or pursuant to a conversion exemption (14 CCR § 1104.1).

945.4 Hours of Operation [Lake County]

Within 300 feet of any occupied dwelling, the operation of power equipment, including chain saws, except licensed highway vehicles, shall be restricted to the hours between 7:00 a.m. and 7:00 p.m. and shall be prohibited on Saturdays, Sundays and nationally designated holidays, except that such operations shall be permitted to occur on Columbus Day. The Director may grant an exception to this rule where the Director has found that no disturbance will result to the occupants of the dwelling from the use of such equipment.

945.5 Exempt and Emergency Notice Operations [Lake County]

Timber Operations may be conducted within the Scenic Combining District in compliance with an Exemption pursuant to 14 CCR § 1038, an Exemption pursuant to 14 CCR § 1104.1, or an Emergency Notice pursuant to 14 CCR § 1052. Such operations, when feasible, shall be conducted in a manner consistent with the limitations described in 14 CCR §§ 945.3(a), subsections (1), (2), and (3); 945.3(b); 945.3(c); and 945.4.

COUNTY RULES, SOUTHERN DISTRICT

965 Monterey County Rules [Monterey County]

In addition to forest practice Rules applying in the Southern Forest District, Rules contained in Sections 965.1 through 965.10 shall apply within the boundaries of Monterey County. Where the Southern Forest District Rules conflict with Monterey County Rules, the Monterey County Rules will apply.

965.1 Haul Routes [Monterey County]

On Timber Operations requiring a plan all haul routes for removing forest products shall be shown on a road map and shall include routes from the harvest site to the mill or county line. Such map shall be submitted with the plan. A proposed change in the use of public roads that are part of the haul route shall be presumed to be a substantial deviation unless the plan submitter requests that the proposed change be considered a minor deviation in accordance with the procedures set forth in 14 CCR 1036 and 1040 and the Director so determines. The Director shall consult with the County Planning Department and Public Works Department before giving approval.

CALIFORNIA FOREST PRACTICE RULES

965.2 Hauling to the Nearest Public Road [Monterey County]

Those portions of offsite haul roads to be used in the conduct of the timber operation, from the area where timber harvesting is to occur to the nearest public road, shall be shown on the plan. In addition to the requirements to furnish a list of certain property owners pursuant to 14 CCR 1032.7 (e), the plan submitter shall furnish to the Department at the time of submission of the plan the names and addresses of property owners with property fronting or bordering that portion of the haul route lying between the plan area and the nearest public road. The Department shall give notice of public hearing if requested by the county to each of these owners and those individuals specified in 14 CCR 1037.1(b) and 1037.3.

965.3 Public Road Protection [Monterey County]

The construction of Logging Roads, tractor roads, or Landings within 100 feet of the edge of the traveled surface of a public road is prohibited except where:

- (a) Logging Roads are needed for access to the area to be harvested.
- (b) It is explained and justified in the plan where construction of these facilities in this area will result in better protection of scenic values or provide better erosion control in the conduct of the timber operation.

965.4 Log Hauling [Monterey County]

- (a) Log hauling on public roads is not permitted on Saturdays, Sundays, or on those days which are nationally designated legal holidays, except that such operations shall be permitted to occur on Columbus Day.
- (b) Log hauling on public roads may be restricted or not permitted by the Director during specified hours to prevent hazardous traffic conditions.

965.5 Winter Period [Monterey County]

The winter period for Monterey County shall be October 15 through April 15.

965.6 Big Sur Coast [Monterey County]

The following Rules shall apply to all THPs within the area covered by the Big Sur Coast Land Use Plan of September 13th, 1984 (Big Sur LUP).

- (a) West of Highway 1 or within the critical viewshed of Highway 1 as defined in the Big Sur LUP only the sanitation-salvage silvicultural method will be permitted.
- (b) Timber Operations outside the critical viewshed of Highway 1 shall be screened from direct public view to the extent feasible by leaving trees and other vegetation between disturbed areas and public roads.
- (c) New road construction is not permitted within the critical viewshed of Highway 1 unless a field review of the proposed road reveals no significant degradation of the critical viewshed. New road construction outside the critical viewshed shall be located to minimize the removal of native trees and shall not be allowed across slopes over 30% unless no feasible alternative exists for the proposed location, or the road better achieves the overall resource protection objectives.
- (d) All excess material resulting from new road construction shall be end hauled and deposited in an area where visual Impact will be minimized. Sidecasting of excess material is prohibited.
- (e) Within environmentally sensitive plant and wildlife habitats as described in the Big Sur LUP the Director shall require a field review by a qualified wildlife biologist prior to approval of the THP. If the field review identifies significant adverse effects to the habitat, the Director shall deny the THP unless measures sufficient to mitigate the adverse effects are included in the THP.
- (f) Within those drainages identified in the Big Sur LUP and designated by Monterey County as watershed resource study areas, the Director shall require a field review by a qualified hydrologist or erosion control specialist prior to approval of the THP. If the field review identifies significant adverse effects to the cumulative water demands of the watershed, the Director shall deny the THP unless measures sufficient to mitigate the adverse effects on water supply are included in the THP.
- (g) In addition to the requirements of 14 CCR 956 through 956.7, the minimum Watercourse and lake protection zone shall be 150 ft. on Class I and II waters unless a smaller zone can be explained and justified in the THP.

CALIFORNIA FOREST PRACTICE RULES

965.7 Public Water Agency Representative [Monterey County]

In the case of any timber operation proposed to be carried out in an area which serves as a watershed for any publicly owned water purveyor, the Director shall request a representative of such water purveyor to assist the Department as an advisor in the review process, pursuant to the provision of 14 CCR 1037.5; such water purveyor representative shall be permitted to participate in all review team meetings.

965.8 Performance Bonding [Monterey County]

When hauling logs pursuant to a THP, the LTO shall provide for the repair of any damage to a county road that is willfully or negligently caused by the LTO's log hauling operations, and shall provide for the repair of any damage caused by the LTO's log hauling operations to appurtenant structures, including, but not limited to, guard rails, signs, traffic signals, culverts, curbs and similar facilities. If necessary to ensure compliance with this section, the county may request, and the Department, upon such request, may require the Timber Operator or responsible party to post adequate financial security to restore paved or unpaved county roads and appurtenant structures which are damaged by log hauling operations. The request for posting of financial security shall be made to the Department during the THP review procedure and no later than five days before the Director's decision date. The Timber Operator or responsible party shall post a certificate of deposit, certificate of insurance or performance bond, or other financial security in favor of the Department in a reasonable amount set by the Director, not to exceed \$5,000 per mile of county road used or \$50,000, whichever is less and subject to provisions of Div. 3, Part I, Chapter 1, Article 8, Sec. 11110 through 11113 of the Gov. C. Such cash deposit or other acceptable financial security shall cover a period not to exceed the effective period of the plan.

When a form of financial security is required, logging trucks shall not use the county roads until the required security is posted with the Department. The Director shall release the bond or equivalent to the principal of the security upon completion of log hauling operations and compliance with the requirements of this section. If and when repairs are necessary, the Director shall request the operator to provide for making the repairs. If the repairs are not made the Department may take corrective action and may order the bond, or equivalent, forfeited in an amount not to exceed actual damage. When a bond or equivalent has been posted, the Department shall provide the county with a copy of the Work Completion Report. The county shall advise the Department in writing within 30 days of its receipt of notification of completion of hauling operations or the Work Completion Report if damage has occurred repairs need to be made. If the county fails to notify the Director within 30 days, the bond of surety shall be released.

965.9 Erosion Control Maintenance [Monterey County]

The plan submitter shall maintain all drainage structures and drainage facilities required by these Rules in effective working condition throughout one winter period after completion of Timber Operations. A work completion report may not be filed until this requirement has been met.

965.10 THP Description [Monterey County]

In addition to the requirements of 14 CCR 1034(g), the THP description shall include the assessor's parcel numbers of all parcels on which Timber Operations will be conducted.

Article 14 Archaeological and Historical Resource Protection [Article 12. Northern]

929, 949, 969 Statement of Purpose [All Districts]

The purpose of this article is to:

- (a) ensure that the significant archaeological and historical sites within the Site Survey Area are adequately identified and protected,
- (b) to provide direction to RPFs preparing THPs (which includes all forms of THPs including, but not limited to, Modified THPs and NTMPs, WFMPs, Program Timber Harvesting Plans (PTHPs)), Notice of Emergency Timber Operations (Emergency Notices), and any Exemption Notices pursuant to 14 CCR §§ 1038 and 1104.1,
- (c) provide direction to the Timber Operator conducting Timber Operations,

CALIFORNIA FOREST PRACTICE RULES

(d) provide direction to the Department in its review, approval and inspection programs.

929.1, 949.1, 969.1 Plan, and Emergency Notice Preparation [All Districts]

(a) Preparing a plan.

Prior to submitting a plan, the RPF, or the RPF's supervised designee:

(1) Shall conduct an archaeological records check at the appropriate Information Center. A previously-conducted archaeological records check for the property may be used to satisfy this requirement if it covers the entire area proposed for Timber Operations and if it meets the definition of "current archaeological records check" in 14 CCR § 895.1.

(2) Shall provide written notification to Native Americans of the preparation of a plan. The primary purpose for this notification is to provide Native Americans an opportunity to disclose the existence of any Native American archaeological or cultural sites that are potentially within or adjacent to the Site Survey Area, and the opportunity to comment on the plan. The RPF shall allow a minimum of 10 days for response to this notice before submitting the plan to the Director. The remainder of the 10-day waiting period is waived when all Native Americans required to be informed respond in less than 10 days. This notice shall contain the following attachments or items of information:

(A) A request for information concerning the potential existence of any Native American archaeological or cultural sites within the plan boundaries.

(B) Information concerning the location of the plan including:

1. A general location map that, at a minimum, shows the travel route from the nearest community or well-known landmark to the plan area.

2. A copied segment of the titled USGS (if available) or equivalent map(s) that displays the approximate boundary of the plan area, and includes a map legend and a scale.

3. A description of the plan location including the county, section, township, range, base and meridian, and the approximate direction and distance from the nearest community or well-known landmark.

(C) A statement that all replies, comments, questions, or other information submitted by Native Americans as a result of this notice be directed to the RPF. The name, address, and phone number of the RPF shall be provided.

(D) Information concerning the available time for response. Indicate that the RPF is requesting a response within ten days from the date of the notice so the information can be incorporated into the plan when initially submitted to the Director. Provide the estimated date the plan will be submitted to Director. Provide the following statement: "The earliest possible date the Director may approve the plan is 16 calendar days after it is submitted to Director, although typically, the plan is reviewed for at least 45 calendar days following plan submittal before the Director approves the plan."

(E) A statement that the Native American groups may participate in the plan review process by submitting written comments to the Director before close of public comment period.

(F) A statement that locations of sites disclosed will be kept confidential.

(G) A statement that a Confidential Archaeological Addendum (CAA) will be prepared for the plan and a copy of pertinent information contained within the CAA may, at the discretion of the Director, be obtained from the Director.

(3) Shall provide a professional archaeologist or a person with archaeological training (in accordance with 14 CCR §§ 929.4, 949.4, and 969.4) to conduct a field survey for archaeological and historical sites within the Site Survey Area. Previous archaeological surveys within the Site Survey Area may also be used to partially or entirely satisfy this requirement.

(4) Shall ensure that research is conducted prior to the field survey, including review of appropriate literature and contacting knowledgeable individual, concerning potential archaeological or historical sites occurring on the property.

(b) Provide Notification to Native Americans if a Native American Archaeological or Cultural Site is located within the plan.

On a plan that contains a Native American archaeological or cultural site as defined in 14 CCR § 895.1 the RPF or the RPF's supervised designee shall:

CALIFORNIA FOREST PRACTICE RULES

(1) provide a written notice to Native Americans informing them of the presence of Native American cultural resources within the Site Survey Area. This notification shall include:

(A) The RPF's name, address, and telephone number.

(B) The name, number, or other designator of the plan.

(C) A list of all known Native American archaeological or cultural sites located within the Site Survey Area, including a name, number or other designator and brief description of each site.

(D) A brief discussion of how each site shall be protected or avoided.

(E) The address and phone number of the appropriate CAL FIRE Review Team Office to contact as listed under 14 CCR § 1032, as well as a statement that written comments may be submitted to the Director for consideration prior to the close of public comment.

(F) The estimated earliest date the Director may approve the plan.

(2) submit a copy of all letters sent pursuant to 14 CCR § 929.1 [949.1, 969.1] (b)(1) to the Director. The Director shall allow a minimum of 15 days from the date of the notification letter for receipt of responses to notices sent pursuant to 14 CCR § 929.1 [949.1, 969.1] (b)(1) prior to the close of public comment.

(c) Submitting a Confidential Archaeological Addendum for a plan.

The RPF shall include the following information in a Confidential Archaeological Addendum with the proposed plan:

(1) Administrative Information which is not confidential and may be released to the public. This includes:

(A) The name, affiliation, address, and phone number of the archaeological surveyor.

(B) The name, affiliation, address, and phone number of the RPF, if different than the archaeological surveyor.

(C) The plan name ascribed by the RPF, plan number (if known), type, and approximate acreage.

(D) The county, legal description, and name of USGS 7.5' Quad(s) within which the project is located.

(E) The date the CAA was completed.

(F) The name of the author of the CAA.

(G) The signature of the RPF or archaeological surveyor.

(2) Archaeological Records Check Information. A copy of the records check and written reply (including mapped information) from the Information Center shall be attached, or a justification as to why that is not possible shall be included.

(A) If the records check request and written reply from the Information Center are attached, no additional information is required.

(B) If the records check request and written reply from the Information Center are not attached, the following information shall be included:

(1) Justification why records check request and written reply could not be attached.

(2) The date the records check was conducted at the Information Center.

(3) The Information Center File Number.

(4) Summary of records check results discussing whether or not archaeological or historical sites are known or suspected to exist within the Site Survey Area and whether or not the Site Survey Area has a previous archaeological investigation on record.

(3) Results of notification to Native Americans pursuant to 14 CCR § 929.1 [949.1, 969.1](a)(2)(B). This shall include:

(A) An example of a notification letter and project maps submitted to Native American contacts.

(B) Copies of any written responses received from Native American contacts.

(C) A list of the individuals or groups that were provided written notification and the date of the Native American Contact List being used.

(D) Date the notification was sent.

(E) Results of the information request, specifically addressing the results of information received from the NAHC, if those results have been received.

CALIFORNIA FOREST PRACTICE RULES

(4) Results of notification to Native Americans of the existence of a Native American archaeological or cultural site on the plan, if required, pursuant to 14 CCR § 929.1 [949.1, 969.1](b).

(5) A list of the research done prior to field survey. This list shall include literature reviewed and persons contacted in addition to the required archaeological records check with Information Center and Native Americans, and a summary of the results of this research.

(6) Information on the current or previous archaeological surveyor(s), which is not confidential. This shall include:

(A) the name of the current archaeological surveyors and an indication of whether or not the person either meets the specifications of a professional archaeologist as defined in 14 CCR § 895.1 or, meets the requirements specified in 14 CCR § 929.4 [949.4, 969.4].

(B) the name of any previous archaeological surveyors, if known.

(7) Description of archaeological survey methods and procedures including survey strategy, time spent conducting archaeological field survey, the date or dates the survey was conducted, survey coverage intensity, and ground visibility or other limitations.

(8) A list and description of all archaeological or historical sites identified within the Site Survey Area including information on the site(s) size, type, and condition. The designations used in this listing of sites found shall be consistently used throughout the CAA.

(9) An Archaeological Coverage Map or maps prepared in accordance with the specifications identified in the definition of an Archaeological Coverage Map in 14 CCR § 895.1.

(10) A preliminary determination of significance of identified archaeological and historical sites, if damaging effects from Timber Operations cannot be avoided. This determination shall be based upon the criteria for a significant archaeological or historical site listed in 14 CCR § 895.1.

(11) Description of any specific enforceable protection measures to be implemented both within the site boundaries and within 100 feet of the site boundaries.

(12) Information concerning the proposed on-site meeting between the RPF or supervised designee familiar with on-site conditions and the LTO to discuss protection of archaeological and historical resources, if required, pursuant to 14 CCR § 929.2 [949.2,969.2](b).

(13) Information concerning site recording requirements pursuant to 14 CCR § 929.1 [949.1,969.1](d) and (g).

(14) Other applicable information, if any, concerning the archaeological survey for this project.

(15) List of attachments to the CAA.

(d) Site Records.

Upon submission of a plan, the RPF or the RPF's supervised designee shall submit completed site records for each site proposed to be a significant archaeological or historical site in a manner consistent with the recording standards identified in the State Office of Historic Preservation's "Instructions For Recording Historical Resources" March, 1995, which is incorporated by reference.

(e) Emergency Notice of 3 Acres Or More.

(1) Prior to submitting an Emergency Notice of three acres or more, the RPF:

(A) Shall ensure that an archaeological field survey is, or has been previously conducted by a professional archaeologist or person with archaeological training (pursuant to 14 CCR § 929.4 [949.4, 969.4]) within the Site Survey Area.

(B) Shall provide written notification to Native Americans of the preparation of an Emergency Notice. The primary purpose for this notification is to provide Native Americans an opportunity to disclose the existence of any Native American archaeological or cultural sites that are potentially within or adjacent to the Site Survey Area, and the opportunity to comment on the Emergency Notice. The RPF shall allow a minimum of seven (7) days for response to this notice before submitting Emergency Notice(s) to the Director. The remainder of the seven (7) day waiting period is waived when all Native Americans required to be informed respond in less than seven (7) days. This notice shall contain the following attachments or items of information:

1. A request for information concerning the potential existence of any Native American archaeological or cultural sites within the Emergency Notice area identified by the RPF.

2. Information concerning the location of the Emergency Notice including:

a. A general location map that, at a minimum, shows the travel route from

CALIFORNIA FOREST PRACTICE RULES

the nearest community or well-known landmark to the Emergency Notice area.

b. A copied segment of the titled USGS (if available) or equivalent map(s) that displays the approximate boundary of the Emergency Notice area, and includes a map legend and a scale.

c. A description of the Emergency Notice location including the county, section, township, range, base and meridian, and the approximate direction and distance from the nearest community or well-known landmark.

3. A statement that all replies, comments, questions, or other information submitted by Native Americans as a result of this notice be directed to the RPF. The name, address, and phone number of the RPF shall be provided.

4. Information concerning the available time for response. Indicate that the RPF is requesting a response within seven (7) days from the date of the notice.

(2) Prior to submitting an Emergency Notice of three acres or more, the RPF or the RPF's supervised designee:

(A) Shall complete a current archaeological records check. This check may be conducted by telephone. If the Information Center is unable to provide the information within three business days following receipt of an RPF's request for an Emergency Notice records check, the records check requirement is waived.

(B) Shall submit a Confidential Archaeological Letter as defined in 14 CCR § 895.1.

(f) Emergency Notice of Less Than 3 Acres.

(1) Prior to submitting an Emergency Notice of less than three acres, the RPF or the RPF's supervised designee shall:

(A) Conduct an archaeological survey for said area to determine whether it contains any significant archaeological sites using the criteria for a significant archaeological or historical site defined in 14 CCR § 895.1.

(B) Send a copy of the Notice to Native Americans.

(2) An archaeological records check, Confidential Archaeological Addendum, or Confidential Archaeological Letter, is not required.

(3) No Timber Operations shall occur within the boundaries of any significant archaeological or historical sites as determined by the RPF or the RPF's supervised designee.

(g) Submitting Archaeological and Historical Information to Information Centers.

Within 30 days following the Director's approval of a plan or acceptance of an Emergency Notice of three acres or larger, the Director shall send to the appropriate Information Center of the California Historical Resource Information System the following information provided by the RPF:

(1) a complete Confidential Archaeological Addendum which includes all changes and additions required in the plan review process and which identifies the plan number, or, for Emergency Notices of three acres or larger, a Confidential Archaeological Letter.

(2) two copies each of any completed archaeological or historical site records for:

(A) archaeological sites determined to be significant, or

(B) sites that a person elects to record, but for which no determination of significance has been made.

The records shall be completed by a person who satisfies the requirements specified in 14 CCR §§ 929.4 [949.4, 969.4] in a manner consistent with the recording standards identified in the State Office of Historic Preservation's "Instructions For Recording Historical Resources" March, 1995, which is incorporated by reference.

(3) The RPF or supervised designee shall ensure that the site records are completed in the manner specified in subsection (2).

929.2, 949.2, 969.2 Protection Measures for Plans and Emergency Notices 3 Acres and Larger [All Districts]

(a) (1) The RPF shall describe in the separate Confidential Archaeological Addendum or Letter, measures to be taken to mitigate or avoid substantial adverse change to any known significant archaeological or historical sites.

CALIFORNIA FOREST PRACTICE RULES

(2) The RPF may propose, and the Director may agree to, site specific protection measures for any identified archaeological or historical site without evaluating the significance of the site. These proposed protection measures shall be designed to ensure protection of such archaeological and historical sites from damaging effects. Avoidance of activities which will cause damaging effects is a preferred protection measure.

(b) The RPF or supervised designee familiar with on-site conditions shall meet with the LTO prior to the start of Timber Operations at each archaeological or historical site that is described in the plan or notice that requires avoidance or other protection measures and do the following:

(1) show the LTO the location, extent and boundaries of each archaeological or historical site requiring protection,

(2) discuss with the LTO the protection measures,

(3) apprise the LTO of the confidentiality requirements for any information concerning the physical location of archaeological or historical sites.

(c) If the RPF or supervised designee is unable to perform the duties in 14 CCR § 929.2 [949.2, 969.2](b), the RPF shall:

(1) explain the reasons in the emergency notice, plan, or as a minor amendment to the plan,

(2) (A) meet with the plan submitter, Timberland Owner, or their authorized agent, and review in the field, the items described in 14 CCR § 929.2 [949.2, 969.2](b),

(B) if the plan submitter, Timberland Owner, or their authorized agent will not comply with the RPF's or RPF's supervised designee's request for a meeting, the RPF shall notify the Director.

(3) except for an emergency notice, notify the plan submitter in writing that it is the plan submitter's responsibility to transfer the information in 14 CCR § 929.2 [949.2, 969.2](b) to the LTO per 1035(h),

(4) notify the Director in writing.

(d) The LTO shall not conduct Timber Operations within the boundaries of any archaeological or historical site identified in the CAA unless such operations are described in the CAA and made part of the plan approved by the Director.

(e) In the event that the CAA authorizes limited Timber Operations within the boundaries of archaeological or historical sites identified in the plan, the LTO and the RPF, if so stated in the plan, shall be responsible for ensuring that specific protection measures and Timber Operations are conducted in the manner described in the CAA.

929.3, 949.3, 969.3 Post Review Site Discovery [All Districts]

If a person discovers a potentially significant archaeological or historical site after a plan, Emergency Notice, or Exemption is accepted by the Director, the following procedures apply:

(a) The person who made the discovery shall immediately notify the Director, LTO, RPF, or Timberland Owner of record.

(b) The person first notified in (a) shall immediately notify the remaining parties in (a).

(c) No Timber Operations shall occur within 100 feet of the identified boundaries of the new site until the plan submitter proposes, and the Director agrees to, protection measures pursuant to 14 CCR § 929.2 (949.2, 969.2).

(d) A minor deviation shall be filed to the plan. The minimum information provided shall include:

(1) A statement that the information is confidential.

(2) The mapped location of the site.

(3) A description of the site.

(4) Protection measures, and

(5) Site records, if site records are required pursuant to 14 CCR §§ 929.1(g)(2)(b) and 929.5 [949.5, 969.5].

(e) Upon receipt, the Director shall immediately provide the proposed minor deviation or portions of the minor deviation, to Native Americans when Native American archaeological or cultural sites are involved.

929.4, 949.4, 969.4 Archaeological Training Requirements [All Districts]

To meet the requirement of 14 CCR § 929.1 [949.1, 969.1], archaeological surveys of a plan, or Emergency Notice areas for archaeological or historical sites shall be conducted only by a professional archaeologist or a

CALIFORNIA FOREST PRACTICE RULES

person who has attended a training program approved by the Director within five years prior to submission of the plan, or Emergency Notice. The training program must meet the following standards:

(a) The course shall use education materials approved by the Director which address the current regulations and procedures for the identification, recordation, and protection of archaeological and historical resources during Timber Operations.

(b) The course may require that the applicant demonstrate, in the field, and in a final written examination, the ability to conduct a record search, perform field identification, complete an archaeological site record, and to identify appropriate mitigation and protection measures for archaeological or historical sites covered in the course.

(c) The Director shall issue a verification to all students that satisfactorily complete the training course.

(d) Following an individual's successful completion of an archaeological training course approved by the Director, he or she may enroll in a refresher training course, approved by the Director, to renew a 5-year archaeological training certification.

(e) The Director may conduct the archaeological training courses (in addition to or in-lieu of approving programs conducted by others) at least annually.

929.5, 949.5, 969.5 Site Recording [All Districts]

The Director shall ensure that all archaeological or historical sites determined to be significant and located within the Site Survey Area on plans, or Emergency Notices are recorded by the RPF or supervised designee in a manner consistent with the recording standards identified in the State Office of Historic Preservation's "Instructions For Recording Historical Resources" March, 1995, which is incorporated by reference.

929.6, 949.6, 969.6 Protection of Sites During Timber Operations [All Districts]

No person, except as otherwise permitted by law, who is involved in Timber Operations shall excavate, collect artifacts from, vandalize or loot archaeological or historical sites located within the THP, Emergency Notice or Exemption boundary.

929.7, 949.7, 969.7 Determination of Significance [All Districts]

(a) A determination of significance shall be made for an identified archaeological or historical site within the Site Survey Area on a THP, or Emergency Notice by a person who satisfies the requirements specified in 14 CCR § 929.4 [949.4, 969.4] if damaging effects from Timber Operations cannot be avoided.

(b) The determination of significance shall:

(1) Be based upon criteria defined for significant archaeological or historical sites in 14 CCR § 895.1

(2) Utilize any information provided by Native Americans, archaeological, historical or ethnographic data pertinent to the region and to the cultural resource, and the physical characteristics of the archaeological or historical site.

(c) If required by subsection (a), a preliminary determination of significance shall be made by the RPF or the RPF's supervised designee and provided in the Confidential Archaeological Addendum.

(d) Where the Director determines that Timber Operations may cause a substantial adverse change to a significant archaeological or historical site and the RPF and the Director cannot agree upon protection measures, a professional archaeologist provided by the THP submitter shall make a survey and prepare a report on the potentially affected site or sites and the potential Impacts of the proposed Timber Operations. The part of the report that relates to archaeological sites is confidential. This report, if it discusses Impacts on Native American archaeological sites, shall be provided by the Director to Native Americans and the NAHC. This report shall contain recommendations for mitigation, the elimination of Impacts, or for the reduction of Impacts to avoid or prevent substantial adverse change to significant archaeological or historical resources. The report shall meet the standards of the Preservation Planning Bulletin, Number 4, December 1989 (Office of Historic Preservation), entitled Archaeological Resource Management Reports (ARMR): Recommended Contents and Format.

The Director shall make the final determination of significance and substantial adverse change based on advice of a professional archaeologist.

CALIFORNIA FOREST PRACTICE RULES

SUBCHAPTER 7 ADMINISTRATION

Article 1 Timber Operator Licenses

1020 Board Authority Delegated

The State Board of Forestry and Fire Protection delegates its authority under Article 6 (commencing with Section 4571) of Chapter 8, Part 2, Division 4 of the PRC, to the Director.

1022 License

The license defined in PRC § 4524, is designated as either "Timber Operator License" (A) , "Limited Timber Operator License" (B), or "Restricted Timber Operator License" (C).

1022.1 Timber Operator License, Limited Timber Operator License, and Restricted Timber Operator License

(a) The Director may issue a License to engage in all Timber Operations. Said License type is designated as "Timber Operator License", or "(A)".

(b) The Director may also issue a license for commercial cutting and/or removal of minor forest products as here listed: Christmas trees, tanbark, fuelwood, root crown burls, posts and split products. Said license type is designated as "Limited Timber Operator License", or "(B)". The following Timber Operations are prohibited under a Limited Timber Operator License:

- (1) Construction or Reconstruction of Logging Roads or Landings
- (2) Abandonment or Deactivation of Logging Roads or Landings
- (3) Construction or Reconstruction of Logging or Tractor Road watercourse crossings
- (4) Timberland Conversion activities pursuant to Article 7 of this subchapter.

(c) The Director may issue a License to an Applicant who is either the sole proprietor of, principal owner of, or principal officer of, an entity that owns the land on which all Timber Operations under the License will be conducted, and the Applicant will supervise those Timber Operations. Proof of such interest shall be provided to the Director prior to the issuance of such a License. Said License type is designated as "Restricted Timber Operator License", or "(C)".

1022.2 License for Site Preparation

A Timber Operator's license is required for Mechanical Site Preparation activities undertaken before the stocking standards of the Act and Rules have been met in a logging area. Site Preparation activities involving Broadcast Burning are exempt from Timber Operator licensing requirements.

1022.3 License for Erosion Control Maintenance

A Timber Operator license is not required for the maintenance of erosion control structures following the completion of Timber Operations described in an approved work completion report for a THP.

1022.4. Licensed Timber Operator Responsibilities.

The person licensed pursuant to this Article, hereinafter referred to as Licensed Timber Operator or LTO, shall be responsible for the work of his or her employees, and all those who the LTO may hire as subcontractors, whether or not such subcontractors are licensed as Timber Operators, except in following case. In those cases where a subcontracting LTO is also listed as a responsible LTO on a timber harvesting plan or other harvest permitting document, such LTO shall be responsible for the work of their own employees and subcontractors, and shall be responsible for compliance with the Forest Practice Act, plan and Board Rules for the Timber Operations for which they are designated in the plan. All LTOs shall familiarize all employees and subcontractors with the intent and details of the operational protection measures of the plan, including amendments and minor or substantial deviations, or any other harvest permitting document or notice that apply to their work. The LTO shall ensure that such employees and subcontractors comply with all other provisions of the Act and Board Rules.

CALIFORNIA FOREST PRACTICE RULES

1022.5. Subcontractors to a Licensed Timber Operator

Except for those to whom PRC § 4576.1 applies, a Timber Operator license is not required of persons, such as timber fallers and independent log haulers, who subcontract with an LTO for specific services during the conduct of Timber Operations and for which the LTO is responsible.

1023 Issuance of License

Upon the Director's determination that an application is complete and accepted for filing, consistent with 14 CCR § 1024.3, and following receipt of payment of the prescribed license fee, the Director shall issue the license requested on the application per 14 CCR § 1025(a).

1023.1 Company, Corporation and Partnership Licenses

Each subsidiary of companies or corporations, and each division thereof that is a separate unit and separately managed, which conducts Timber Operations shall be individually licensed. Partnership consisting of individual licensees and operating as a co-partnership must obtain a license as a partnership. A license is not transferable.

1024 Application Form and Content

Application for a license, or renewal of license, in a form prescribed by the Director, shall contain, and is not limited to, the following information:

- (a) Specific type of license requested.
- (b) Name in which License is to be issued.
- (c) Name, mailing address and street address of applicant.
- (d) Satisfactory proof of identity.
- (e) Name and address of principal officer in California for service of documents.
- (f) Name, mailing address and telephone number of the Insurance Agent providing the Insurance Certificate when such certificate is required by PRC 4572.
- (g) If a corporation, name of state of incorporation, address of home office, is different from (c) above, address of California office, name and address of resident agent in California for service, and the name and address of the individual who will attend the Timber Operator education program for the corporation, if required.
- (h) If not a California corporation, or if an individual, firm, or partnership that has no office in California, name and address of a natural person that applicant designates as resident agent in California for service.
- (i) The application must contain a consent for the Director, and agents and employees thereof, to inspect Timber Operations of the applicant.
- (j) All Timber Operator License Applications shall have a Certificate of Completion from a Timber Operator education program approved by the Director attached to the application unless, the applicant has held a prior license.

1024.1 Timber Operator Education

The Director shall only approve Timber Operator education programs which meet the following standards:

- (a) The course shall use education materials approved by the Director. The Director shall only approve materials which address the contents of the Rules of the Board.
- (b) Certificate of Completion shall be given when an applicant successfully completes the Timber Operator education program. An applicant shall have successfully completed the Timber Operator education program if he/she has attended the entire program and has completed all training materials. The Director may conduct the Timber Operator education programs in addition to or in-lieu of approving programs conducted by others.

1024.2 Qualifying Experience

"Work experience", within the meaning of Public Resources Code section 4572(b)(2)(A), shall include, but not be limited to, such Timber Operations activities as felling, bucking and limbing of logs, cable

CALIFORNIA FOREST PRACTICE RULES

rigging, choker setting, heavy equipment operation, Yarding, loading and hauling of logs, Logging Road building and waterbreak installation, or on site assistance with any of these activities. General construction and reforestation work such as brush removal and tree planting are not qualifying experience. Direct supervision of Timber Operations shall meet the requirement for having experience in "two or more areas of employment".

1024.3 Application Processing

(a) The applicant shall be informed by the Department, in writing and postmarked, within 15 working days of receipt of the application, whether such application is complete and accepted for filing, or is deficient and what specific information is required.

(b) The applicant shall be informed of the Department's decision on licensure, in writing and postmarked, within 15 working days of filing a complete application.

(c) The actual minimum, median and maximum processing times for an application from the time of receipt of the application until the Department makes a final decision on the application are:

- (1) Minimum: 1 hour;
- (2) Median: 5 days;
- (3) Maximum: 168 days.

1024.4 Returned Checks

Any fee payment document which is returned unpaid for any reason from the institution upon which the document is drawn, shall render the application incomplete, and any license issued pursuant to that fee payment document shall be invalid at the end of 10 working days following written notice to the applicant. If payment by cash, cashier's check, or money order is received within the 10 day period, such license shall continue without interruption. If payment is not received within the 10 working day period, the license shall remain invalid and a new license shall be required.

1024.5 Insurance Maintenance

Licensees shall maintain in force an insurance policy, if required, as defined in subsection (c) of PRC 4572. Failure or refusal to do so shall render the application incomplete, and a license shall be invalid. If an Insurance Certificate showing insurance coverage is received by the Department demonstrating no lapse in insurance coverage, the license shall continue without interruption. If no such Insurance Certificate is received, the license shall remain invalid and a new license shall be required.

1024.6. Employee with Wages as Sole Compensation

(a) "Employee with wages as sole compensation" within the meaning of PRC § 4526.5 and 4528.5 shall be persons for whom all of the following characteristics are present:

- (1) Receive compensation from hourly wages paid at least twice during each calendar month pursuant to Labor Code § 204, or are salaried and paid at least monthly. ("Wages" does not include any "commission" or compensation calculated solely as a percentage of an employer's business, or contract revenue.)
- (2) The employer pays unemployment insurance premiums, deducts Federal and State income tax withholding, Social Security and Medicare deductions from each pay check, and is required by law to forward such withholdings to the appropriate government entity.
- (3) The employer covers such person with worker's compensation and any needed liability insurance.

1025. Fees for Licenses.

(a) The following annual License fees shall prevail:

- (1) "Timber Operator License", or "A"
New License \$75.00.
Renewal License \$50.00.
- (2) "Limited Timber Operator License", or "B"
New License \$35.00.

CALIFORNIA FOREST PRACTICE RULES

Renewal License \$25.00.

(3) “Restricted Timber Operator License”, or “C”

New License \$75.00.

Renewal License \$50.00.

1026 License Renewal

Licenses are good only for the calendar year(s) issued.

(a) **New licenses.** For a new license, a person shall submit the appropriate and complete application, insurance certificate, if needed, and fees. A new license shall be valid from the date of issuance to January 1st of odd-numbered years for odd-numbered licenses and January 1st of even-numbered years for even-numbered licenses. The fee for a newly issued license shall be based on a proration of the annual rate as provided in section 1025.

(b) **Renewals.** A completed application for renewal shall be submitted to the Director on alternating years with odd-numbered licenses expiring on January 1st of odd-numbered years and even-numbered licenses expiring on January 1st of even-numbered years. All licenses for which renewal applications, with the required fee, are not received by the Director, or postmarked, on or before December 1st shall expire on January 1st and a new license shall be required.

1027 License Denial

An application for a license or an application for renewal of a license may be denied by the Director upon a statement of issues in accordance with the procedures set forth in Chapter 5 (commencing with Section 11500) of Part 1, Division 3, Title 2 of the Government Code.

1027.1 Basis of Denial

The Director may deny issuance of any license either upon original application or upon application for renewal for any of the reasons set forth in PRC 4573. In addition, the Director may deny any application for renewal until any violations of the Rules and regulations of the Board and provisions of the Forest Practice Act by the applicant as exist on the date of submission of the renewal application, of which the applicant has been notified and given reasonable opportunity to correct, are corrected on such reasonable terms and conditions as the Director may require.

1027.2 Partnership and Corporation Denials

Licenses and renewals may be denied partnerships where one of the partners had uncorrected violations within 3 years of the application. If a corporation is owned or controlled by a person denied a license or a renewal, the corporation may be denied a license or a renewal pending satisfactory correction of the deficiencies and adherence to the Forest Practice Act and Rules, or removal of said person.

1027.3 Multiple licenses

Only one (1) license may be issued to any partnership, corporation, or individual business entity.

1029 License Availability.

The license, or copy of it, shall be available for inspection at the site of active Timber Operations.

1030 Licensee: Change of Address

a. The licensee shall:

1. Maintain a California mailing address to which official written communications from the Director shall be sent and received.

2. Provide such address on licensee's application.

3. Notify the Director at the Sacramento office in writing within 15 days of any change of address.

b. The Director shall maintain all names and mailing addresses in a registry to be used for service of documents pursuant to section 11505 of the Government Code.

CALIFORNIA FOREST PRACTICE RULES

Article 2 Timber Harvesting Plan

1032 Timber Harvesting Plan Filing Locations

The Timber Harvesting Plan for proposed Timber Operations required by PRC § 4581 shall be submitted in writing to the Director on a form that meets these regulations at the following CAL FIRE Review Team Offices as appropriate:

Review Team Office Location

Forest Practice Program Manager
California Department of Forestry
and Fire Protection
135 Ridgway Ave.
Santa Rosa, California 95401-4318
707-576-2959

Forest Practice Program Manager
California Department of Forestry
and Fire Protection
6105 Airport Road
Redding, California 96002
530-224-2445

Forest Practice Program Manager
California Department of Forestry
and Fire Protection
1234 E. Shaw Avenue
Fresno, California 93710
559-243-4100

Review Team Office Location

Environmental Coordinator
California Department of Forestry
and Fire Protection
P.O. Box 944246
Sacramento, California 94244-2460
Or
715 P Street
Sacramento, California 95814
916-902-5090

For Timber Operations In:

Alameda, Colusa, Contra Costa, Del Norte, Humboldt,
Lake, Marin, Mendocino, Napa, San Mateo, Santa Clara,
Santa Cruz, Solano, Sonoma, western Trinity, and Yolo
counties.

Butte, Glenn, Lassen, Modoc, Nevada, Placer, Plumas,
Shasta, Sierra, Siskiyou, Sutter, Tehama, eastern Trinity,
and Yuba counties.

Alpine, Amador, Calaveras, El Dorado, Fresno, Imperial,
Inyo, Kern, Los Angeles, Madera, Mariposa, Merced,
Mono, Monterey, Orange, Riverside, San Benito, San
Bernardino, San Diego, San Luis Obispo, Santa Barbara,
Stanislaus, Tuolumne, Tulare, and Ventura Counties.

For Timber Operations In:

All Counties for Timberland Conversion Applications,
Timberland Conversion Permit Application Fees, and
Conversion Plans.

1032.7 Plan Submittal and Notice of Intent

(a) A Plan shall be submitted by the person who owns, leases, contracts, or operates on Timberland to harvest timber for commercial purposes.

(b) Where the land or timber is owned or operated by parties other than the person executing the Plan the person submitting the Plan shall give prompt written notice of such Plan to those parties.

(c) The RPF preparing the Plan shall submit to the Director, with the Plan, a Notice of Intent to Harvest Timber (Notice of Intent) if:

(1) any proposed boundary lies within three-hundred (300) feet of any property not owned by the

CALIFORNIA FOREST PRACTICE RULES

Timberland Owner, or

(2) any Plan amendment that changes a Plan boundary so that the new boundary lies within three-hundred (300) feet of property not owned by the Timberland Owner, or

(3) any Plan amendment changes the silvicultural method if a Notice of Intent was required for the Plan by condition (1) or (2) above, or

(4) any overhead electrical power line, except a line from a transformer to a service panel, is present within the Plan area or within two-hundred (200) feet outside the Plan boundary, or

(5) any Plan amendment changes a Plan boundary so that any overhead electrical power line, except a line from a transformer to a service panel, is within the new boundary area or within two-hundred (200) feet outside the Plan boundary.

(d) A Notice of Intent shall include the following information:

(1) The names of the Timberland Owner, the RPF who prepared the Plan, and the Plan Submitter.

(2) The location of the Plan area by county, section, township, and range, and the approximate direction and distance to the Plan area from the nearest community or well-known landmark.

(3) The name of and distance from the nearest perennial Stream and major Watercourse flowing through or downstream from the Plan area.

(4) The acres proposed to be harvested.

(5) The Silvicultural Systems to be used, including Regeneration Methods, Intermediate Treatments, Special Prescriptions, and Alternative Prescriptions.

(6) The estimated earliest date that the Director may approve the Plan. This is fifteen (15) days from receipt of the Plan by the Department, except in counties for which Rules and regulations have been adopted pursuant to Sec. 4516.5 and 4516.8 of the PRC where the earliest date the Director may approve the Plan is forty-five (45) days after the receipt of the Plan by the Department.

(7) A statement that the public may review the Plan at the appropriate CAL FIRE Review Team Office and that a copy of the Plan may be obtained from the Department upon payment of the applicable charge.

(8) A map which provides the approximate boundary of the THP area, a map legend, and a scale. This map shall be posted with the Notice of Intent.

(9) A statement that questions or concerns regarding the specific Plan should be directed to the applicable CAL FIRE Review Team Office for public input incorporation into an Official Response Document.

(10) A statement of whether there is a known overhead electric power line within the proposed Plan area except a line from a transformer to a service panels.

(e) The RPF preparing the Plan shall furnish to the Department at the time of submission of the Plan, the names and mailing addresses of all property owners within three-hundred (300) feet of the Plan boundary. Either a list compiled from the latest equalized assessment roll or a list provided by a title company doing business in California compiled within sixty (60) days of submission of the Plan shall be deemed sufficient for compliance with the subsection.

(f) The RPF preparing the Plan shall furnish to the Department at the time of submission of the Plan, the names and mailing addresses of the utilities that operate overhead electrical power lines within the Plan boundary or within two-hundred (200) feet outside the Plan boundary. This information shall be obtained from the Utility Contact List.

(g) The Department shall mail copies of the Notice of Intent within two (2) working days of receipt of the Plan to all persons identified in (e) and (f) above.

(h) Prior to submission of the Plan, the person submitting the Plan shall post a copy of the Notice of Intent including a map as described in (d)(8) at a conspicuous location on the public road nearest the Plan. Said Notice of Intent shall be on colored paper or identified with colored flagging so as to be easily visible to the public.

1032.8 Notice of Intent-Distribution by Director

The Director shall distribute copies of each Notice of Intent within two working days of receipt to:

(a) The office of the County Clerk of the county in which operations are proposed for posting at the customary place for posting environmental affairs.

CALIFORNIA FOREST PRACTICE RULES

- (b) The local Ranger Unit headquarters for posting.
- (c) At such other locations as the Director may deem desirable and feasible to provide adequate public notice.

1032.9 Request for Notification of Timber Harvesting Plan Submission

- (a) Each applicable CAL FIRE Review Team Office shall maintain a list of plans submitted each day.
- (b) When any person requests notice of submissions of timber harvesting plans, the Director shall provide the person, free of charge, with a copy of the list of timber harvesting plans submitted on the date or dates requested. If no specific date is requested, a copy of the lists for the preceding week shall be provided.

1032.10 Request for Information on Domestic Water Supplies

The THP submitter shall provide notice by letter to all other landowners within 1,000 feet downstream of the THP boundary whose ownership adjoins or includes a Class I, II, or IV Watercourse(s) which receives surface drainage from the proposed Timber Operations. The notice shall request that the THP submitter be advised of surface domestic water use from the Watercourse, within the THP or within 1,000 feet downstream of the THP boundary. When required to notice by letter, publication shall also be given one time by the THP submitter in a newspaper of general circulation in the area affected by the proposed project. Such letter and publication shall notify the party of the proposed timber operation and describe its legal location and identify the name, if any, of the Watercourse it may effect. The letter and publication shall request a response by the property owner within ten days of the post-marked date on the letter or the date of publication as appropriate. The RPF may propose, with justification and explanation, an exemption to such notification requirements, and the Director may agree. Copies of either notice, proof of service and publication, and any responses shall be attached to the THP when submitted. If domestic use is noted, the plan shall contain mitigations necessary to protect domestic water use. The plan shall not be submitted until ten days after the above notification(s) have been done.

1033 Filing Date

The filing date is the date on which the plan is found by the Director to be accurate, complete, and in proper order.

1034 Contents of Plan

The plan shall serve two functions: to provide information the Director needs to determine whether the proposed timber operation conforms to the Rules of the Board; and to provide information and direction to Timber Operators so that they comply with the Rules of the Board. For the plan to serve these functions, it shall, as a minimum, contain the following information:

- (a) Name, address, and telephone number of the Timber Owner(s).
- (b) Name, address and telephone number of the Timberland Owner(s).
- (c) Name, address telephone number, and license number of the Timber Operator(s).
- (d) Name, address, and telephone number of a person to be contacted on the operation who will be responsible for the conduct of the timber operation. If unknown at the time of plan submission, it shall be provided prior to the start of Timber Operations.
- (e) Name, address, and telephone number of the plan submitter. If the submitter is not a person indicated in (a), (b), or (c) above, an explanation of his/her authority to submit the plan shall be provided.
- (f) Name, address, telephone number, and registration number of RPF who prepared the plan. The plan required for Timberland conversion does not have to be prepared by an RPF, [ref. PRC 4622].
- (g) A description of the plan area within which Timber Operations are to be conducted. The description shall include the following:
 - (1) U.S. Geological Survey (USGS) Quadrangle name(s) and date(s),
 - (2) township, range, and section number(s),
 - (3) county name(s),
 - (4) CALWATER 2.2 planning watershed number(s), and
 - (5) approximate acreage.
- (h) The forest district and subdistrict (if any) in which the timber operation is located.

CALIFORNIA FOREST PRACTICE RULES

- (i) Whether a Timberland conversion certificate is in effect, its date of expiration, and its identification number.
- (j) Whether a plan is on file with the Department for any part of the plan area for which a Report of Satisfactory Stocking has not been issued by the Department (show plan number).
- (k) Expected dates of commencement/completion of Timber Operations.
- (l) The types of forest products to be harvested and if management of broadleaf or optional species is being proposed.
- (m) Identity of the regeneration methods, intermediate treatments, special harvesting methods, alternative prescriptions, and any information specified by the district Rules. Also for THPs that do not reference an approved Sustained Yield Plan, or do not demonstrate achievement of MSP pursuant to 913.11(c), the following applies:

 - (1) The plan shall provide a description of the stand before and after harvesting including: volume, growth projection, stocking, and species composition.
 - (2) The Director may require such additional information as necessary and feasible to demonstrate how maximum sustained production of high quality timber products will be achieved for an ownership within a THP.
- (n) Type of Yarding (logging) systems and equipment to be used. Yarding systems will be placed in one or more of the following groups:

 - (1) Animal
 - (2) Tractor, skidder, forwarder
 - (A) Non-tethered
 - (B) Tethered
 - (3) Cable
 - (A) Ground-lead
 - (B) High-lead
 - (C) Skyline
 - (4) Balloon, helicopter
 - (5) Other, as explained in the plan
- (o) The classification and approximate length of each of the following Logging Road segment categories: constructed, Reconstructed, and abandoned.
- (p) Whether the RPF has informed the Timber Owner, Timberland Owner and Timber Operator of their responsibilities for compliance with the stocking requirements of the Act and Rules, and for maintenance of erosion control structures.
- (q) Whether the RPF will be supplying the Timber Operator with a copy of the approved THP.
- (r) How the requirements of 14 CCR 1032.7(f) are to be met.
- (s) If an archaeological survey has been made on the area to be harvested.
- (t) If there are any recorded archaeological or historical sites in the area to be harvested, and how the sites are to be protected if they exist.
- (u) Where the Timber Owner or Timberland Owner has not signed the plan, indication that written notice of such plan has been given to either or both of these persons, as required by 14 CCR 1032.7(b).
- (v) Whether there are any adverse insect, disease, or pest problems in the plan area and what mitigating measures, if any, will be used to improve the health and productivity of the stand.
- (w) Information on the presence and protection of known habitat or individuals of any listed species and information on the presence and protection of non-listed species which may be significantly Impacted by the timber operation.
- (x) On titled USGS (if available) or equivalent topographic maps of a scale not less than 2" to the mile, the information in subsections (1)-(3), (4)(A), (B) and (E) ((4)(B) and (E) for sites within the harvest area), (8), (9), and (11)-(13) shall be clearly shown. Additional maps, which may be topographic or planimetric, may be used to provide the information required in the other subsections, to show specific details, and to improve map clarity. The appurtenant roads referenced in subsections (4)(B), (C), (D), and (E) ((4)(B) and (E) for sites not within the harvest area) may be shown on a map which may be planimetric with a scale as small as one-half inch equals one mile. Color coding shall not be used. A legend shall be included indicating the meaning of the symbols used. See the district Rules for the appropriate minimum mapping

CALIFORNIA FOREST PRACTICE RULES

acreages.

- (1) Boundaries of logging area (shall be shown on quadrangle map or its equivalent).
 - (2) Boundaries of regeneration methods, intermediate treatments, special harvesting methods, and alternative prescriptions that are to be applied.
 - (3) Boundaries of Yarding (logging) systems, if more than one system is to be used.
 - (4) Location of all roads to be used for, or potentially Impacted by, Timber Operations. This shall include:
 - (A) The classification of all roads as permanent, seasonal, temporary, deactivated, or proposed for Abandonment .
 - (B) Roads and Landings located in Watercourses, lakes, WLPZs, marshes, and Wet Meadows and Other Wet Areas, other than at road Watercourse crossings.
 - (C) Logging Roads that provide access to rock pits and water drafting sites, and the location of water drafting sites.
 - (D) Public roads within one-quarter (1/4) mile of the harvest area.
 - (E) The location of significant existing or potential erosion sites on all roads and Landings pursuant to 14 CCR § 923.1(e).
 - (5) The following shall be mapped at the scale required under subsection (x) for all constructed and Reconstructed Logging Roads and Landings, unless otherwise described:
 - (A) Location of Logging Road grades greater than 15 percent for over 200 continuous feet or Logging Road grades exceeding 20 percent.
 - (B) Location of road failures on existing Logging Roads to be Reconstructed.
 - (C) Location of Logging Roads across and Landings on unstable areas or connected headwall swales.
 - (D) Location of Landings that require substantial excavation and Landings in excess of one-quarter acre in size.
 - (E) Location of excess material disposal sites on slopes greater than 40 percent or on active unstable areas.
 - (F) Location of Logging Roads and Landings across slopes greater than 65 percent for 100 lineal feet or more.
 - (G) Location of Logging Roads and Landings across slopes greater than 50 percent for 100 lineal feet or more within 100 feet of the boundary of a WLPZ that drains toward the zoned Watercourse or lake.
 - (6) The location of all new permanent constructed, Reconstructed, and temporary Logging Road Watercourse crossings, including those crossings to be abandoned or deactivated, shall be shown on a map.
 - (7) Location of all tractor road Watercourse crossings of classified Watercourses except temporary crossings of Class III Watercourses without flowing water during Timber Operations at that crossing.
 - (8) Location of erosion hazard rating areas, if more than one rating exists.
 - (9) Location of Watercourses and lakes with Class I, II, III, or IV waters.
 - (10) Location of known unstable areas or slides.
 - (11) Location of understocked areas prior to Timber Operations, and other areas not normally bearing timber to at least a 20-acre minimum, or as specified in the district Rules.
 - (12) Location of boundaries of timber-site classes needed for determination of stocking standards to be applied, down to at least a 20-acre minimum or as specified in the district Rules.
 - (13) Location of main ridge tops on the logging area suitable for fire suppression efforts that will require the felling of snags.
 - (14) Location of Coastal Commission Special Treatment Areas or any special treatment area.
 - (15) Location for which heavy equipment use is proposed on unstable areas, or on areas for which tractor use is proposed beyond the limitations of the standard forest practice Rules.
 - (16) Location of any in lieu use of heavy equipment and location of tractor roads in Watercourses, lakes, WLPZs, marshes, Wet Meadows and Other Wet Areas.
 - (17) Boundaries of any areas where Tractor Operations are proposed for use on areas designated for Cable Yarding.
- (y) Any additional information that is submitted on separate pages shall be clearly marked "plan addendum"

CALIFORNIA FOREST PRACTICE RULES

and shall bear the date on which it was prepared.

(z) Explanation and justification for, and specific measures to be used for tractor operations on unstable areas, on slopes over 65%, and on areas where slopes average over 50% and the EHR is high or extreme.

(aa) Explanation and justification for tractor operations in areas designated for Cable Yarding.

(bb) Winter period operating plan where appropriate or required.

(cc) Explanation and justification for use of Watercourses, marshes, Wet Meadows and Other Wet Areas as tractor roads.

(dd) Explanation and justification of any in-lieu practices for Watercourse and lake protection.

(ee) Explanation of alternatives to standard Rules for harvesting and erosion control.

(ff) Any other information required by the Rules or the Act to be included in the plan.

(gg) A general description of physical conditions at the plan site, including general soils and topography information, vegetation and stand conditions, and watershed and Stream conditions.

1034.2 Professional Judgment

Where the Rules or these regulations provide for the exercise of professional judgment by the forester (RPF) or the Director, the parties, at the request of either party shall confer on the plan area during the initial pre-harvest inspection provided for by law to reach agreement if possible on the conditions and standards to be included in the plan.

1035 Plan Submitter Responsibility

The plan submitter, or successor in interest, shall:

(a) Ensure that an RPF conducts any activities which require an RPF.

(b) Provide the RPF preparing the plan or amendments with complete and correct information regarding pertinent legal rights to, interests in, and responsibilities for land, timber, and access as these affect the planning and conduct of Timber Operations.

(c) Sign the THP certifying knowledge of the plan contents and the requirements of this section.

(d) (1) Retain an RPF who is available to provide professional advice to the LTO and Timberland Owner upon request throughout the active Timber Operations regarding:

(A) the plan,

(B) the Forest Practice Rules, and

(C) other associated regulations pertaining to Timber Operations,

(2) The plan submitter may waive the requirement to retain an RPF to provide professional advice to the LTO and Timberland Owner under the following conditions:

(A) the plan submitter provides authorization to the Timberland Owner to provide advice to the LTO on a continuing basis throughout the active Timber Operations provided that the Timberland Owner is a natural person who personally performs the services of a professional forester and such services are personally performed on lands owned by the Timberland Owner;

(B) the Timberland Owner agrees to be present on the logging area at a sufficient frequency to know the progress of operations and advise the LTO, but not less than once during the life of the plan; and

(C) the plan submitter agrees to provide a copy of the portions of the approved THP and any approved operational amendments to the Timberland Owner containing the General Information, Plan of Operations, THP Map, Yarding System Map, Erosion Hazard Rating Map and any other information deemed by the Timberland Owner to be necessary for providing advice to the LTO regarding Timber Operations.

(3) All agreements and authorizations required under 14 CCR § 1035(d)(2) shall be documented and provided in writing to the Director to be included in the plan.

(e) Within five working days of change in RPF responsibilities for THP implementation or substitution of another RPF, file with the Director a notice which states the RPF's name and registration number, address, and subsequent responsibilities for any RPF required fieldwork, amendment preparation, or operation supervision. Corporations need not file notification because the RPF of record on each document is the responsible person.

(f) Provide a copy of the portions of the approved THP and any approved operational amendments to the LTO containing the General Information, Plan of Operations, THP Map, Yarding System Map, Erosion

CALIFORNIA FOREST PRACTICE RULES

Hazard Rating Map and any other information deemed by the RPF to be necessary for Timber Operations .

(g) Notify the Director prior to commencement of Site Preparation operations. Receipt of a burning permit is sufficient notice.

(h) Disclose to the LTO, prior to the start of operations, through an on-the-ground meeting, the location and protection measures for any archaeological or historical sites requiring protection if the RPF has submitted written notification to the plan submitter that the plan submitter needs to provide the LTO with this information.

1035.1 Registered Professional Forester Responsibility

(a) Upon submission of a THP, the RPF who prepares and signs a Plan is responsible for the accuracy and completeness of its contents.

(1) The RPF preparing the Plan shall state in the THP the work which will be performed by the RPF plan preparer (beyond preparation of the THP and attending the pre-harvest inspection if requested by the Director), and any additional work requiring an RPF which the plan preparer does not intend to perform. This may include, but is not limited to, field work in identifying WLPZ or Special Treatment Areas, marking trees, or other activities. The RPF is only responsible for the activities set forth in the Plan when employed for that purpose, or required by Board Rules. The RPF shall state whether or not they have been retained to provide professional advice throughout the Timber Operations.

(2) The RPF preparing the Plan shall in writing, inform the plan submitter(s) of their responsibility pursuant to 14 CCR § 1035, and the Timberland Owner(s) of their responsibility for compliance with the requirements of the Act and where applicable, Board Rules regarding Site Preparation, stocking, and maintenance of roads, Landings, and erosion control facilities.

(b) Upon entering into an agreement to accept responsibility for any part of the preparation or implementation of a Plan or any work beyond the preparation of a Plan, including providing professional advice; the responsible RPF(s) shall disclose to the real party of interest for whom the RPF is providing professional forestry services any known current or potential conflict of interest the RPFs have with regard to the timber or land that is subject to operations under the Plan. All responsible RPFs shall disclose to the Timberland Owner and plan submitter whether they are the real party of interest for whom the RPF is providing professional forestry services.

(c) Disclosure of newly discovered conflicts of interest an RPF has with regard to the plan submitter, Timberland Owner, Timber Owner, the LTO and timber purchaser, pertaining to the timber or land that is subject to operations under the Plan, shall be required as long as an RPF has responsibilities relative to the Plan. The disclosure shall include identification of the real party of interest for whom the RPF is providing professional forestry services.

(d) All disclosures made between an RPF and an affected party pursuant to this section may be kept confidential.

(e) An RPF retained by the plan submitter to provide professional advice throughout the Timber Operations shall be present, or ensure that the RPF's Supervised Designee is present, on the Logging Area at a sufficient frequency to know the progress of operations and advise the LTO and Timberland Owner, but not less than once during the life of the Plan.

(f) An RPF retained by the plan submitter to provide professional advice throughout Timber Operations, or the RPF's Supervised Designee, shall inspect the Logging Area prior to the commencement of operations each year to verify that operational flagging and timber marking required of an RPF, is accurate, adequate and in conformance with Board Rules and the approved Plan.

(g) An RPF retained by the plan submitter to provide professional advice throughout the Timber Operations shall inform the LTO during Timber Operations of any mitigation measures incorporated into the Plan that are intended to address Timber Operations that have a high likelihood of resulting in immediate, significant and long-term harm to the natural resources of the state if such mitigation measures are not strictly applied to minimize such Impacts.

(h) The RPF shall without delay notify in writing the LTO, the plan submitter, and the Department of a decision to withdraw professional services from the Plan.

1035.2 Interaction Between RPF and LTO

CALIFORNIA FOREST PRACTICE RULES

(a) After approval of the Plan preparation process but before commencement of Timber Operations by each LTO assigned to the Plan, the responsible RPF or Supervised Designee, shall meet with either the LTO, or their representative, who will be on the ground and directly responsible for Timber Operation. The purpose of the meeting shall be for the RPF to familiarize the LTO with the Plan, the Plan area, and specific applicable requirements of the Plan. The meeting shall be on-site if requested by either the RPF or LTO. An on-site meeting is required between the RPF or supervised designee familiar with on-site conditions and LTO to discuss protection of any archaeological or historical sites requiring protection if any such sites exist within the Site Survey Area pursuant to Section 929.2[949.2,969.2](b).

(b) The RPF shall notify the LTO of any amendment to the Plan, affecting Timber Operations. An on-site meeting to review amendments affecting Timber Operations shall occur if requested by either the RPF or LTO.

1035.3 Licensed Timber Operator Responsibilities

Each affected LTO shall:

(a) Sign the Plan and major amendments to the Plan, or sign and file with the Director a facsimile of such Plan or amendments, agreeing to abide by the terms and specifications of the Plan. This shall be accomplished prior to implementation of the following; which the affected LTO has responsibility for implementing:

(1) those operations listed under the Plan and

(2) those operations listed under any amendments proposing substantial deviations to the Plan.

(b) Inform the responsible RPF or plan submitter, either in writing or orally, of any site conditions which in the LTO's opinion prevent implementation of the approved Plan including amendments.

(c) Keep a copy of the applicable approved Plan and amendments available for reference at the site of active Timber Operations. The LTO is not required to possess any confidential addenda to the Plan such as the Confidential Archaeological Addendum, nor is the LTO required to keep a copy of such confidential Plan addenda at the site of active Timber Operations.

(d) Comply with all provisions of the Act, Board Rules, the applicable approved Plan and any approved amendments to the Plan.

(e) An LTO shall not be held responsible for Forest Practice Rule violations that result from work required of and/or performed by an RPF, under Board Rules, that is determined by the Director to be inaccurate or inadequate.

(f) Provide the RPF responsible for professional advice throughout the Timber Operations an on-site contact employee authorized by the LTO to receive RPF advice.

(g) Keep the RPF responsible for professional advice throughout the Timber Operations advised of the status of timber operation activity.

(1) Within five days before, and not later than the day of the start-up of a timber operation, the LTO shall notify the RPF of the start of Timber Operations.

(2) Within five days before, and not later than the day of the shutdown of a timber operation, the LTO shall notify the RPF of the shutdown of Timber Operations.

(A) The notification of the shutdown of Timber Operations is not required if the period of the shutdown does not extend beyond a weekend, including a nationally designated legal holiday.

(h) Upon receipt of written notice of an RPF's decision to withdraw professional services from the Plan, the LTO or on-site contact employee shall cease Timber Operations, except for emergencies and operations needed to protect water quality, until the LTO has received written notice from the plan submitter that another RPF has visited the Plan site and accepts responsibility for providing advice regarding the Plan as the RPF of record.

1035.4 Notification of Commencement of Operations

Each calendar year, within fifteen days before, and not later than the day of the startup of a timber operation, the Timber Harvesting Plan Submitter unless the THP identifies another person as responsible, shall notify CAL FIRE of the start of Timber Operations. The notification, by telephone or by mail, shall be directed to the appropriate CAL FIRE Unit Headquarters, Forest Practice Inspector, or other designated personnel.

CALIFORNIA FOREST PRACTICE RULES

1036 Deviations [Relocated to 895.1 Definitions.]

1036.1 Murrelet Protection before Notice of Completion

For any THP which has been found to be in conformance with THP filing and review procedures and approved by the Director, but as to which no Notice of Completion (PRC § 4586) has been filed, when there is evidence that the THP area contains an active murrelet site or possesses a potential Impact to a murrelet, the THP submitter shall immediately request a conference with CDFW or USFWS (in the event of Federal listing) to determine appropriate measures for protection of the species. Any additional mitigations for species protection which are developed through consultation with CDFW or the USFWS after initial submittal of the THP shall be submitted to the Director in the form of an amendment to the THP pursuant to 14 CCR § 1036.

1037 THP Preharvest Inspection-Filing Return

Within ten (10) days of the receipt of a plan, or within twenty (20) days of the receipt of a plan to which a Road Management Plan is appended, the Director shall determine if the plan is accurate, complete and in proper order, and if so, the plan shall be filed. During this same period, the Director shall determine if a preharvest inspection is necessary. When the Director finds a plan inaccurate, incomplete or otherwise not in proper order, the plan shall be returned to the submitter with written specifications of the deficiencies.

If a preharvest inspection is to be held, the LTO who will operate under the plan, if known, shall be invited to participate.

1037.1 Notice of Filing

(a) The Director shall prepare a notice of filing which shall contain the basic information contained in the Notice of Intent (14 CCR 1032.7) plus the assigned timber harvesting plan number.

(b) Within two working days of the date the plan is filed, the Director shall transmit copies of the Notice of Filing to:

- (1) The person submitting the plan.
- (2) The office of the County Clerk of the county in which the operations are proposed. The notice shall be posted at the normal place for posting environmental notices.
- (3) The local Ranger Unit headquarters for posting.
- (4) At such other locations as the Director may deem desirable and feasible to provide adequate public notice.
- (5) All public agencies having custodial responsibility for lands within 91.44 m. (300 ft.).
- (6) Anyone else, as required by Public Resources Code Sections 4582.4 and 4582.6.

1037.3 Agency and Public Review

(a) Upon receipt of the filed plan in accordance with 14 CCR § 1037, the Director shall place it, or a true copy thereof, in a file available for public inspection, and shall transmit a copy to the CDFW, the appropriate RWQCB, the CGS, the Department of Parks and Recreation, the county planning agency and, if the areas are within their jurisdiction, to the California Tahoe Regional Planning Agency and the California Coastal Commission.

(b) The Director shall also transmit a copy of any specific plan to any person who has made a written request therefor.

(c) The Department shall bill such persons for the cost of providing such copies and such monies shall be paid to the Department.

(d) The Director shall invite written comments, and will consider these comments. All comments regarding plans shall be in writing and shall be addressed to the Director at the appropriate CAL FIRE Review Team Office where the plan is filed. Comments from reviewing public agencies shall be considered based on the comments' substance, and specificity, and in relation to the commenting agencies' area(s) of expertise and statutory mandate, as well as the level of documentation, explanation or other support provided with the comments.

(e) Any substantial deviation in the plan or the inclusion of significant new information (as described in 14

CALIFORNIA FOREST PRACTICE RULES

CCR § 895.1), made during the Director's review of the plan shall require recirculation as described in this section and reopening or extending the public comment period for a minimum of thirty days.

(f) The Director shall take the following steps when significant new information is added to the plan during the course of plan review or during the Director's Determination period.

(1) When significant changes are limited to a few sections or portions of the plan, the Department need only recirculate the sections or portions that have been modified.

(2) When significant changes are not limited to a few sections of the plan, the Department shall recirculate the entire plan.

(3) The Department shall prepare a Letter of Recirculation which shall include:

(A) A brief description of the proposed project and its location. Such information shall include:

1. The Plan number and County.
2. The names of the Timberland Owner and the Plan Submitter.
3. The location of the plan area by county, section, township, and range.
4. The name of the nearest major Watercourse or CAL Watershed ID.
5. The acres proposed to be harvested.
6. The silvicultural systems to be used.

(B) A summary of changes made to the plan and a brief description of significant new information contained in the plan.

(C) Clarification as to whether the entire plan or only those recirculated portions of the plan, are open for public comment.

(D) The starting and ending dates for the review period during which public comments will be received.

(E) The date, time, and place of any scheduled public meetings when known by the lead agency at the time of notice.

(F) The address where copies of the plan record is available for public review.

(4) The Letter of Recirculation shall be sent to all review team members; any agency, person, or organization that commented on the plan; and all landowners who received a Notice of Intent (or Preparation).

(5) The Department need only respond to:

(A) Comments received during the initial circulation period that relate to sections or portions of the plan that were not revised and recirculated, and

(B) Comments received during the recirculation period that relate to the sections or portions of the plan that were revised and recirculated.

(6) The Department shall include with the Notice of Submissions, a Notice of Recirculation pursuant to 14 CCR § 1032.9.

1037.4 Director's Determination

The Director shall have 30 days from the date the initial inspection is completed (ten of these days shall be after the final interagency review), or in the event the Director determines that such inspection need not be made, 15 days from the date of filing of an accepted plan in accordance with 14 CCR § 1037, or such longer period as may be mutually agreed upon by the Director and the person submitting the plan, to review the plan and take public comment. After the initial review and public comment period has ended, the Director shall have up to fifteen working days, or a longer period mutually agreed upon by the Director and the person submitting the plan, to review the public input, to consider recommendations and mitigation measures of other agencies, to respond in writing to the issues raised and to determine if the plan is in conformance with the applicable Rules adopted by the Board. The Director shall insure that an interdisciplinary review team has had an opportunity to review each plan. The Director shall review and consider the recommendations made on each plan by the interdisciplinary review team before determining if the plan conforms to the Rules of the Board. The Director shall consider all written comments regarding the plan.

1037.5 Review Teams to be Established

Interdisciplinary review teams shall be established by the Director to review plans and assist the Director in

CALIFORNIA FOREST PRACTICE RULES

the evaluation of proposed Timber Operations and their Impacts on the environment.

(a) Review Team Composition: Each review team, when possible, shall consist of a representative from each of the following agencies: the appropriate RWQCB, CDFW, CGS, a representative of county government when the county government so requests, California Coastal Commission (for plans in the coastal zone), California Tahoe Regional Planning Agency (for plans in the Tahoe Basin) and the CAL FIRE. The Director shall request a representative from the Department of Parks and Recreation in the case of plans that may affect values in publicly owned parks. The Director may request other federal, state or county agencies, or Native Americans as defined in 14 CCR § 895.1, when appropriate, to assist as advisors in the review process. The CAL FIRE's representative shall be the review team Chairperson and shall be an RPF.

(b) Review Team Function: The function of the review team shall be to assist the Director in determining if plans are in conformance with Board Rules and to evaluate the potential environmental Impacts of Timber Operations. Review criteria employed by a team shall be consistent with this function. The Board's regulations provide direction for those situations noted during the review which are not addressed by specific Rules (14 CCR 898.1(f), 901- 903.2, 1655 & PRC 4555). In evaluating a plan, the review team shall review any discussion of feasible alternatives or additional mitigation to the proposed timber operation as prescribed in 14 CCR 898. Plan reviewers must consider the economic as well as the environmental benefits of feasible alternatives. The review team shall serve in an advisory capacity to the Director in making recommendations on plans.

In the event that any member of the review team concludes that the plan as filed would have a significant adverse effect on the environment, that member shall explain and justify this conclusion in writing as specifically as possible. The member shall provide in writing suggested site-specific mitigation measures, if any, that will substantially lessen the Impacts.

(c) Chairperson Tasks: The Department is the lead agency in the review of plans. The review team chairperson shall direct the review team meetings, coordinate the interdisciplinary review of plans and develop recommendations on plans for the Director's consideration.

(d) Review Team Meetings. The Director or his designee is responsible for establishing and scheduling the meeting of a review team to perform the necessary review of plans for the Department.

Review team meetings shall be open to the RPF, supervised designee, the landowner, and the Timber Owner and, insofar as possible without disrupting the work of the team, to the public. The chairperson may impose limitations on the scope of any public participation at the meetings. All interested persons will normally be allowed to attend team meetings. On occasions when space or other considerations will require some limitation on attendance the review team chairperson shall endeavor to allow for attendance of at least one representative for each of the various agencies, organizations or special interest groups.

(e) Non-Concurrence: If a member of the review team does not concur with the chairperson's recommendation to the Director, the member shall submit in writing, within five days of the review team meeting and before the action required by 14 CCR 1037.4, the specific reasons why the recommendation does not provide adequate protection of the resources for which his or her agency has responsibility. The submission to the Director shall also include recommendations on measures or actions the Director should take to address the asserted deficiency, as provided by the Rules of the Board. A non-concurring member's comments shall be considered based on the comment's specificity and relation to the member agency's area(s) of expertise and statutory mandate, as well as the level of documentation, explanation or other support provided with the comments. If a non-concurrence is filed on a plan, the review team chairperson shall prepare a written report explaining how the concerns cited in the non-concurrence have been addressed in the plan and how the natural resources of concern will be protected during Timber Operations.

(f) Mitigation: Mitigation and protective measures developed by members of the review team shall be consistent with 14 CCR 1037.3, 1037.5(b), 1037.5(h), and PRC 4582.6(b). Unless the RPF and review team member agree to mitigation measure(s), such mitigation and protective measures shall be explained and justified in writing and be based upon the evaluation of site-specific conditions at the appropriate scale.

(1) During the review of a plan, including the pre-harvest inspection, members of the review team may recommend incorporation of mitigating measures into the plan which are consistent with the forest practice Rules and which would improve the plan or assist in significantly lessening adverse Impacts of the operation on any Timberland resources. The submitter may or may not agree with concerns expressed by the

CALIFORNIA FOREST PRACTICE RULES

suggestions or may offer alternatives. If the submitter, after consultation with the RPF who prepared the plan, agrees with the suggested mitigation measures or changes, they are to be incorporated in the plan. The Director may only require incorporation into the plan of mitigation measures that are based on Rules of the Board.

(2) Members of the review team may suggest protective measures for incorporation into the plan when authority for such measures is not contained in the Rules and regulations of the Board. If the RPF rejects incorporation of such measures into the plan, the Director shall determine if approval of the plan without the suggested measures could result in immediate significant, and long-term harm to the natural resources of the state. If the Director finds that the state's resources are so endangered, the provisions of PRC 4555 shall be followed.

(g) Review of Plans by Review Teams: Before the Director makes a determination on a plan, a review team shall review the plan. The review team shall do the following:

(1) Before the Director accepts a plan for filing or before the fifth working day after filing, a review team shall review the plan. The purpose of this review is to assist this Department in determining whether a preharvest inspection (initial inspection) is necessary and what areas of concern are to be examined during the inspection, if it is to be made. If a preharvest inspection is determined by the Department to be unnecessary, the review team shall make its recommendation to the Director no later than five working days after a plan is filed.

(2) After the preharvest inspection and before the Director's determination on a plan, the review team shall meet to review all the information on the plan and develop a recommendation for the Director.

(3) Requests, if any, for additional information, from the plan submitter during the review period shall be as prescribed by Section 1034 and other conditions in the Rules. Such requests shall be supported by reasons for the request. During the review period, the Director shall be responsible for determining whether requests for information not contained in the plan as filed or developed in preharvest inspection by review team members, reviewing agencies and members of the public, are consistent with the Forest Practice Rules, are reasonably necessary and should be requested from plan submitters. The Director's determination of additional information to be provided by plan submitters shall be guided by standards of practicality and reasonableness, recognizing the statutory review period of the FPA, the requirements of 14 CCR 1034 and the availability of information from alternative sources.

(h) Review Team Recommendations: The review team chairperson shall develop for each plan reviewed, a recommendation for the Director's consideration. When developing recommendations the review team chairperson shall carefully consider all the information available and the views and opinions expressed by all team members. The advice of review team members shall be utilized in determining whether appropriate alternatives have been selected and included in a plan and if implementation of the plan would cause significant damage to natural resources. The Director shall evaluate the review team recommendation in light of their specificity, as well as the level of documentation, explanation or other support provided with the recommendation and the agency's statutory mandates and areas of expertise.

(i) Communications with Plan Submitter: The plan submitter, and the RPF who prepared the plan, and review team members, shall be provided by the Department with copies of preharvest inspection reports, nonconcurrences and review team recommendations so they are kept informed and are better able to respond promptly to the Department relative to changes that may be needed in a plan before it is acted upon by the Director.

1037.6 Nonconformance of Plan

If the Director determines that a plan is not in conformance with the Rules of the Board the plan shall be returned in accordance with 14 CCR 1054. In addition, the Director shall state any changes and reasonable conditions that in the Director's professional judgment are needed to bring the plan into conformance with the applicable Rules of the Board and offer to confer with the RPF in order to reach agreement on the conditions necessary to bring the plan into conformance.

1037.7 Conformance of Plan

If the Director determines that the plan is in conformance with the Rules of the Board, then the person submitting the plan shall be notified, and Timber Operations thereunder may commence.

CALIFORNIA FOREST PRACTICE RULES

1037.8 Notice of Conformance

At the time the Director notifies the plan submitter that the plan has been found in conformance, as described in 14 CCR 1037.7, the Director shall transmit a notice thereof to the agencies and persons referred to in 14 CCR 1037.3, and for posting at the places named in 14 CCR 1037.1. A copy of the notice shall be filed with the Secretary for Resources. The notice of conformance shall include a written response of the Director to significant environmental issues raised during the evaluation process.

1037.9 Public Inspection

Notices of Conformance, pursuant to 14 CCR 1037.7 and notices of approval by the Board, pursuant to 14 CCR 1037.6, shall be available for public inspection and a list of such notices shall be posted on a weekly basis in the Office of the Resources Agency. Each such list shall remain posted for a period of 30 days.

1037.10 Review Period Waiver

In counties for which Rules and regulations have been adopted pursuant to Section 4516.5, no timber harvesting plan shall be approved by the Director until 35 days from the date of filing of the plan unless the Director finds that the proposed Timber Operations will cause no significant environmental damage or threat to public health and safety or the environment or that the Timber Operations are necessary to reduce such a threat. The Director may waive or shorten the time period for approval:

(a) If all of the following are true of the plan:

- (1) No new road construction;
- (2) No road reconstruction that involves substantial change in the original road prism;
- (3) No Timber Operations on slopes in excess of 60%;
- (4) No Timber Operations in Special Treatment Areas;
- (5) No Timber Operations within Watercourse and lake protection zones;
- (6) No Timber Operations on unstable soils;
- (7) No Timber Operations within 500 ft. of an active nesting site rare or endangered bird species;
- (8) No Timber Operations on areas with high or extreme erosion hazard rating;
- (9) The harvest area will be stocked at completion of Timber Operations;
- (10) No threat to public safety is involved; and
- (11) No public hearing has been requested by the county.

(b) Or if the Director finds that he or she must approve a plan quickly so as to adequately protect the public health and safety, or the environment and that such protection cannot be adequately provided under the normal Rules of the Board for plan review. The basis for the finding must be stated in writing before the Timber Harvesting Plan is approved.

1037.11 Notice of Waiver

If the Director decides to waive or shorten the time period for plan review pursuant to 14 CCR 1037.10, he or she shall give notice within three working days of that determination to all persons or agencies to whom a Notice of Intent was sent.

1038 Exemption

Timber Operations conducted pursuant to this section are exempt from the Plan preparation and submission requirements (PRC § 4581) and from the completion report and Stocking report requirements (PRC §§ 4585 and 4587) of the FPA. Timber Operations conducted under any notice of exemption described herein shall be limited to one (1) year from the date of receipt by the Director, and shall comply with all operational provisions of the FPA and District Forest Practices Rules applicable to "Timber Harvest Plan", "THP", and "Plan" definitions per 14 CCR § 895.1. In-lieu practices within WLPZs as specified under Article 6 of these Rules, exceptions to the Rules, and alternative practices are not allowed. The following types of Timber Operations are exempt:

- (a) Harvesting Christmas trees.
- (b) Harvesting dead trees, Dying Trees, or Diseased Trees of any size, fuelwood or split products in

CALIFORNIA FOREST PRACTICE RULES

amounts less than ten (10) percent of the average volume per acre, or the removal of Slash and Woody Debris that is not located within a WLPZ.

(c) The cutting or removal of trees in compliance with PRC §§ 4290 and 4291, which eliminates the vertical continuity of vegetative fuels and the horizontal continuity of tree crowns for the purpose of reducing flammable materials and maintaining a fuelbreak to reduce fire spread, duration and intensity. The requirements of this subsection shall not supersede the requirements of PRC § 4291.

(1) Only trees within one-hundred-fifty (150) feet from any point of an Approved and Legally Permitted Structure that complies with the California Building Standards Code may be harvested, except as specified in 14 CCR § 1038(c)(6).

(2) The following Silvicultural Methods may not be used: clearcutting, Seed Tree removal step, shelterwood removal step.

(3) All surface fuels created by Timber Operations, within one-hundred-fifty (150) feet of an Approved and Legally Permitted Structure, that could promote the spread of wildfire, including Slash or Woody Debris, exceeding one (1) inch in diameter, and brush, shall be chipped, burned, or removed within forty-five (45) days from the start of Timber Operations.

(4) In addition to the surface fuel treatment described in 14 CCR § 1038(c)(3), the Harvest Area must meet the vegetation treatment standards in PRC § 4584(i)(1) to (2)(A) illustrated in Board Technical Rule Addendum No.4 within one (1) year from the receipt of issuance of notice of acceptance. This paragraph does not apply to 14 CCR § 1038 (c)(6).

(5) Timber Operations conducted under this subsection shall conform to the applicable city or county general plans, city or county implementing ordinances, and city or county zoning ordinances within which the notice of exemption is located. The LTO, timberland owner, or if applicable the RPF, shall certify that the city or county has been contacted and the notice of exemption conforms with all city or county regulatory requirements.

(6) Trees that are located from one-hundred-fifty (150) feet up to three-hundred (300) feet from any point of an Approved and Legally Permitted Habitable Structure that complies with the California Building Standards Code may also be cut and removed for the purpose of reducing flammable materials and maintaining a fuelbreak provided the following conditions are met:

(A) The post-harvest stand shall be primarily comprised of healthy and vigorous Dominant and Codominant trees well-distributed throughout the treated area and meet the Stocking Standards consistent with 14 CCR § 913.2 [933.2, 953.2].

(B) The (QMD) of trees greater than eight (8) inches dbh in the pre-harvest Harvest Area shall be increased in the post-harvest stand.

(C) All Slash shall be lopped, removed, chipped, piled and burned, or otherwise treated to achieve a maximum post-harvest depth of eighteen (18) inches above the ground within forty-five (45) days from the start of Timber Operations except for the burning of piles, which shall be accomplished not later than April 1 of the year following their creation, or for piles created on or after September 1, not later than April 1 of the second year following creation. Treatment of surface fuels by burning shall be exempt from the one-year time limitations on Timber Operations described under 14 CCR § 1038.1.

(D) The notice of exemption shall include site class, an estimate of pre- and post-harvest QMD and certification by the RPF that, in their professional judgment, post-harvest Slash treatment and stand conditions will lead to more moderate fire behavior.

(E) 14 CCR § 1038(c)(6) shall expire pursuant to PRC 4584(m)(3).

(d) Harvesting dead trees, Dying Trees or Diseased Trees, fuelwood, or split products in response to drought related stress or dead trees which are unmerchantable as sawlog-size timber from that are located upon Substantially Damaged Timberland when the following conditions are met:

(1) The RPF certifies that the notice of exemption is submitted upon Substantially Damaged Timberland when necessary.

(2) Trees eligible for removal when harvesting in response to drought related stress shall meet one (1) or more of the following conditions:

(A) Trees that are dead, or,

(B) Trees with fifty (50) percent or more of the foliage-bearing crown that is dead or fading in color from a normal green to yellow, sorrel, or brown, excluding normal autumn coloration changes, or

CALIFORNIA FOREST PRACTICE RULES

with evidence of successful bark beetle attacks, through indications of dead cambium and brood development distributed around the circumference of the bole, or;

(C) The RPF, in writing, within the submitted notice of exemption, certifies that trees are designated, by an RPF or Supervised Designee, with a stump mark, as likely to die due to drought related stress within one (1) year.

(e) The cutting or removal of trees to restore and conserve California black (*Quercus kelloggii*) or Oregon white (*Quercus garryana*) oak woodlands and associated grasslands, if all the following requirements are met:

(1) The Harvest Area does not cumulatively exceed, during any five (5) year period, three-hundred (300) acres per ownership in a Planning Watershed (CALWATER 2.2), for the timberland owner(s) identified pursuant to 14 CCR § 1038.1(a)(2).

(2) Upon submission, the notice of exemption shall include:

(A) Total acreage of the exemption Harvest Area per Planning Watershed (CALWATER 2.2).

(B) A description of the pre-harvest and post-harvest stand structure including an estimate, by species, of diameter distribution, and basal area.

(C) A certification that states:

1. That a minimum of thirty-five (35) square feet of basal area per acre of California black or Oregon white oak, or both, occupy the Harvest Area prior to Timber Operations; and

2. That the proposed Timber Operations are designed to restore and conserve California black oak and Oregon white oak and associated grasslands.

(3) No trees larger than twenty-six (26) inches stump diameter, measured eight (8) inches above ground level may be removed for commercial purposes.

CALIFORNIA FOREST PRACTICE RULES

BOARD OF FORESTRY TECHNICAL RULE ADDENDUM NO. 4

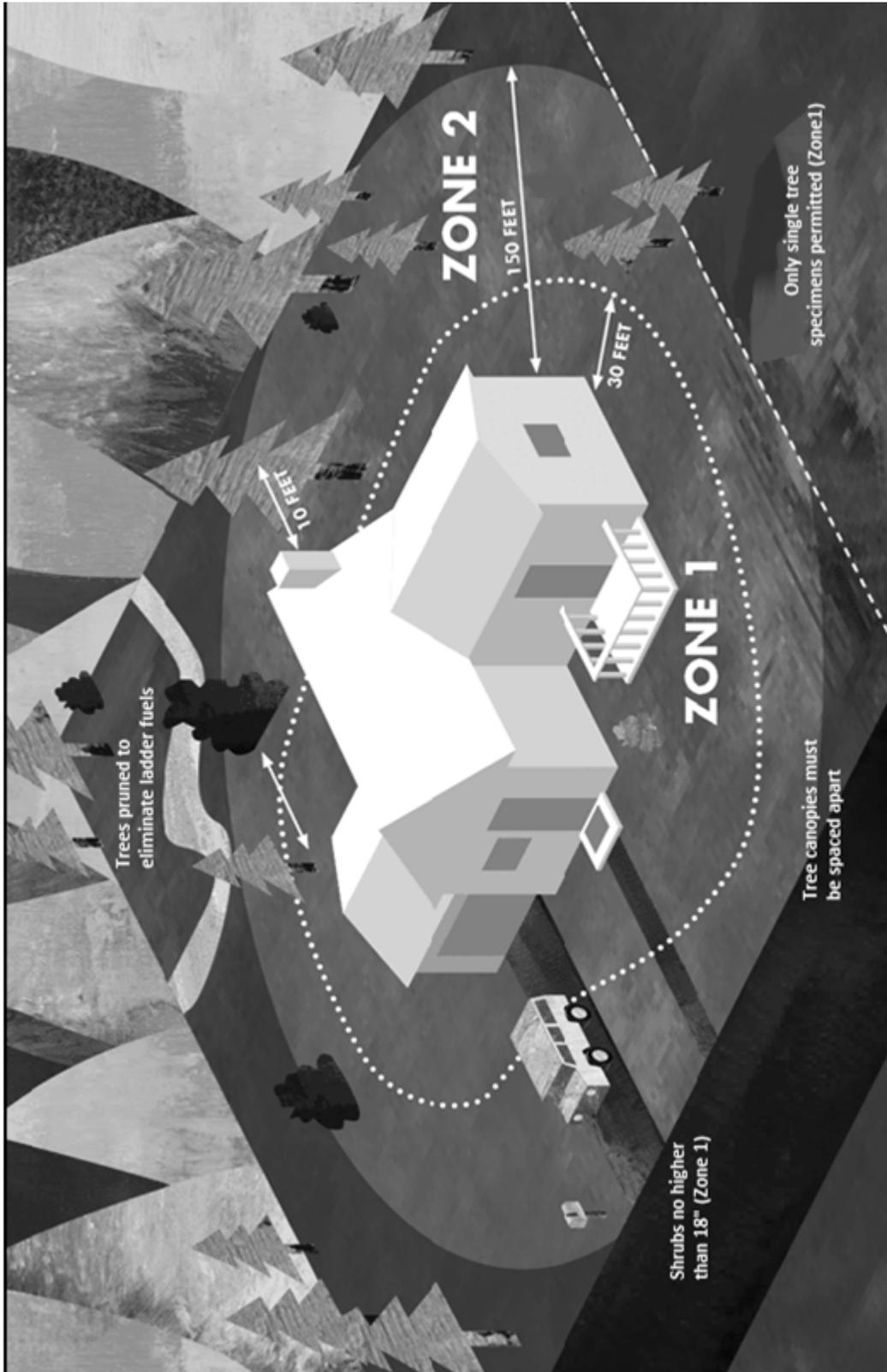

CALIFORNIA FOREST PRACTICE RULES

BOARD OF FORESTRY TECHNICAL RULE ADDENDUM NO. 4

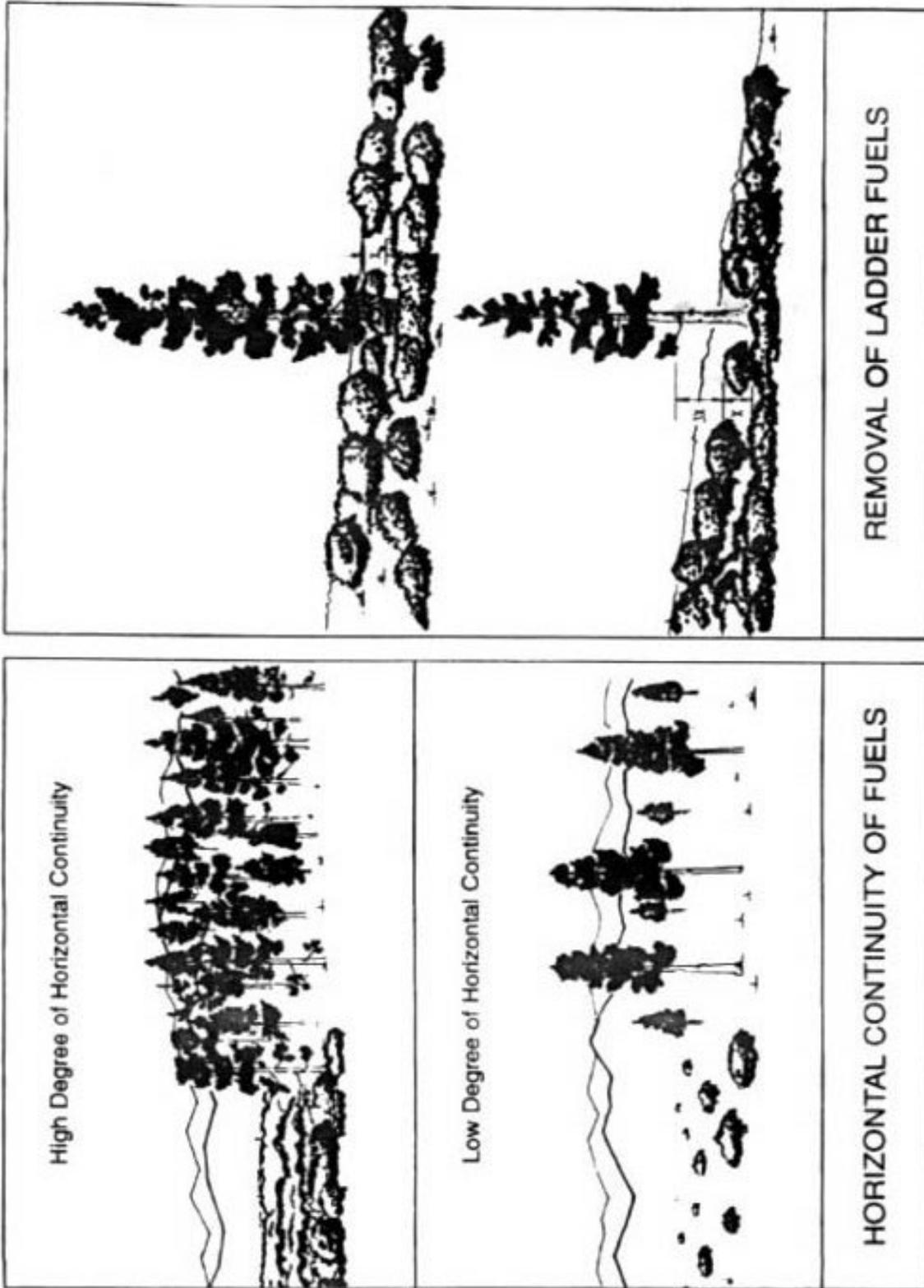

Incline Village/Crystal Bay Detachable Space Handbook, University of Nevada, Reno, 1991

CALIFORNIA FOREST PRACTICE RULES

(4) The post-harvest stand shall meet, at a minimum, the following criteria:

(A) A minimum of eighty (80) percent of the pre-treatment basal area of California black oak or Oregon white oak, or both, shall be retained; and

(B) A minimum of thirty-five (35) square feet of basal area of California black oak or Oregon white oak, or both, shall be retained; and

(C) Conifer Stocking, measured in basal area, shall represent less than twenty-five (25) percent of the total onsite Stocking of all trees within the Harvest Area. Decadent and Deformed Trees of Value to Wildlife (excluding hardwoods) shall not count towards this required Stocking Standard.

(D) All harvested conifers shall be within three-hundred (300) feet of a California black oak or Oregon white oak that is a minimum of four (4) inches dbh.

(E) As well as compliance with applicable Slash requirements pursuant to Table 1 of 14 CCR § 1038.1, all Slash shall be configured in a manner that minimizes risk of fire related mortality to all retained California black oak and Oregon white oak.

(5) A notice of exemption pursuant to this subsection is not applicable within the Southern Sub-District of the Coast Forest District, or the Southern Forest District.

(f) The cutting or removal of trees that eliminates the vertical continuity of vegetative fuels and the horizontal continuity of tree crowns for the purpose of reducing flammable materials and maintaining a Fuelbreak. An exemption pursuant to this subdivision shall be known as the Small Timberland Owner Exemption. The cutting or removal of trees in compliance with this subdivision shall be subject to all of the following conditions:

(1) A notice of exemption pursuant to this subsection is limited to small forest landowners who own:

(A) Sixty (60) acres or less of timberland within a single Planning Watershed (CALWATER 2.2) within the Coast Forest District, or;

(B) One-hundred (100) acres or less of Timberland within a single Planning Watershed (CALWATER 2.2) within the Northern or Southern Forest Districts.

(2) The RPF shall, upon submission of the notice of exemption, include a description of the pre-harvest stand structure and a statement of the minimum expected post-harvest stand Stocking levels. The residual stand shall consist primarily of healthy and vigorous dominant and codominant trees from the pre-harvest stand, well distributed throughout the Harvest Area. Minimum post-harvest stocking standards shall be achieved through Unevenaged Management, excluding group selection, and shall be as follows:

(A) On Site I lands, a minimum of one-hundred-fifty (150) square feet of basal area shall be retained within the Coast Forest District, while a minimum of one-hundred (100) square feet of basal area shall be retained within the Northern and Southern Forest Districts.

(B) On Site II lands, a minimum of one-hundred (100) square feet of basal area shall be retained within the Coast Forest District, while a minimum of seventy-five (75) square feet of basal area shall be retained within the Northern and Southern Forest Districts.

(C) On Site III lands, a minimum of seventy-five (75) square feet of basal area shall be retained.

(D) On Site IV and V lands, a minimum of fifty (50) square feet of basal area shall be retained.

(3) The QMD of trees greater than eight (8) inches dbh in the pre-harvest Harvest Area shall be increased in the post-harvest stand. The submitted notice of exemption shall report the expected post-harvest increase in QMD.

(4) Only trees less than thirty-two (32) inches stump diameter, measured at eight (8) inches above ground level, may be removed, with the following exception:

(A) No trees of the genus *Quercus sp.* that are greater than twenty-six (26) inches stump diameter, measured at eight (8) inches above ground level, may be removed.

(5) The six (6) largest trees per acre within the boundaries of the notice of exemption shall be retained.

(6) The post-harvest tree species composition shall be representative of the pre-harvest stand condition and demonstrate progression towards climax forest conditions, unless the RPF provides a justification, submitted with the notice of exemption, explaining how modification of the tree species diversity will benefit forest health and resiliency.

CALIFORNIA FOREST PRACTICE RULES

(7) Vertical spacing in the Harvest Area shall be achieved by treating dead fuels, excluding dead branches on the trees retained for stocking, to a minimum clearance distance of eight (8) feet measured from the base of the live crown of the post-harvest Dominants and Codominants to the top of the dead surface or ladder fuels, whichever is taller.

(8) The post-harvest canopy closure for trees which are Dominants and Codominants shall comply with the standards of 14 CCR § 1052.4(d)(3)(A).

(9) All trees to be harvested, or all trees to be retained, shall be marked by a RPF, or their Supervised Designee, prior to commencing timber felling.

(10) Timber Operations conducted under a notice of exemption pursuant this subdivision shall only occur once over a ten (10) year period on any given acre. During this ten (10) year period, the Director shall not approve a Plan that allows for an even-aged silvicultural prescription(s), or an RPF shall not submit a notice of exemption pursuant to 14 CCR § 1038.3, for acres where Timber Operations occurred under a notice of exemption pursuant to this subsection.

(11) The Department shall only accept a maximum of three (3) notices of exemption pursuant to this subsection submitted on behalf of a timberland owner.

(12) This subsection will expire five (5) years after the date of its effectiveness.

(g) Harvesting trees which are dead or Dying Trees as a result of wildfire within three-hundred (300) feet from any point of an Approved and Legally Permitted Structure or an Approved and Legally Permitted Structure that was damaged or destroyed by wildfire. The provisions of a notice of exemption submitted pursuant to this subsection supersede the provisions of any other notices of exemption that are submitted in the same Harvest Area. The following conditions apply:

(1) Only trees within three-hundred (300) feet from any point of an Approved and Legally Permitted Structure or an Approved and Legally Permitted Structure that was damaged or destroyed by wildfire may be harvested.

(2) Timber Operations conducted pursuant to this subsection shall be permitted if either:

(A) Timber Operations are consistent with, and within the geographic scope of, an existing valid and effective gubernatorial proclamation of a state of emergency or executive order. If the proposed Timber Operations are consistent with, and within the geographic scope of such a proclamation or order, the timberland owner shall submit a copy of the valid and effective gubernatorial proclamation of a state of emergency or executive order with the notice of exemption described within 14 CCR § 1038.1; or

(B) Timber Operations are necessary to remove trees which are dead or Dying Trees as a result of a wildfire which occurred no more than three (3) years prior to the submission of a notice of exemption as described within 14 CCR § 1038.1, but such Timber Operations are not consistent with, or within the geographic scope of, an existing valid and effective gubernatorial proclamation of a state of emergency or executive order. In such an instance, the timberland owner shall submit, to the Director, certification by an RPF that all trees proposed for harvest are dead or Dying Trees as a result of such a wildfire. This certification shall be included with the submitted notice of exemption as described within 14 CCR § 1038.1.

(3) Timber Operations conducted under this subsection shall conform to applicable city or county general plans, city or county implementing ordinances, and city or county zoning ordinances within which the Harvest Area is located. The Timber Operator or timberland owner shall certify that the city or county has been contacted and the Timber Operations conducted under the notice of exemption conforms with all city or county regulatory requirements.

(4) All Slash and Woody Debris greater than one (1) inch but less than eight (8) inches in diameter within one-hundred-fifty (150) feet of an Approved and Legally Permitted Structure or an Approved and Legally Permitted Structure that was damaged or destroyed by wildfire shall be removed, chipped, or piled and burned.

(5) All Slash created between one-hundred-fifty (150) feet and three-hundred (300) feet of an Approved and Legally Permitted Structure or an Approved and Legally Permitted Structure that was damaged or destroyed by wildfire shall be treated by Lopping For Fire Hazard Reduction, removed, chipped, or piled and burned within forty-five (45) days from the start of Timber Operations; except for the burning of piles, which shall be accomplished not later than April 1 of the year following their creation; or for piles created on or after September 1, not later than April 1 of the second year following creation.

CALIFORNIA FOREST PRACTICE RULES

1038.1 Additional Exceptions or Requirements

Preparation or submittal of a notice of exemption described in 14 CCR § 1038, or Timber Operation thereunder, shall comply with the additional exceptions or requirements as described.

(a) A notice of exemption, pursuant to 14 CCR § 1038, shall be submitted to the Director, on a form provided by the Department, prior to the commencement of Timber Operations. The form shall contain the following information:

- (1) The type of exemption.
- (2) Name(s), address, and telephone number(s) of the Timber Owner(s), timberland owner(s), and Timber Operator.
- (3) Name, address, and telephone number and license number of the RPF, if applicable.
- (4) Legal description of the location of the Timber Operation.
- (5) The tentative date of commencement of Timber Operations.
- (6) A signature of the landowner certifying that they are the landowner and have read and understand the information contained within the notice of exemption.

(b) For notices of exemption pursuant to 14 CCR § 1038, the additional requirements apply:

- (1) All Timber Operations conducted in the Lake Tahoe Region must have a valid Tahoe Basin Tree Removal Permit, as defined by TRPA, or shall be conducted under a valid TRPA Memorandum of Understanding, when such a permit is required by TRPA.
- (2) The Department shall provide the appropriate RWQCB, CDFW, and CGS with copies of the submitted notice of exemption prior to the tentative date of commencement of Timber Operations.
- (3) No helicopter yarding shall be allowed.

(c) The following additional exceptions or requirements apply to exemptions pursuant to 14 CCR § 1038 as provided in Table 1 below:

Table 1: Additional Exceptions or Requirements

Applicable Exceptions or Requirements	Notice of Exemption Type(s)
14 CCR § 1038.1(c)(1)	14 CCR § 1038(c)(6), (d), (e), and (f)
14 CCR § 1038.1(c)(2)	14 CCR § 1038 (e) and (f)
14 CCR § 1038.1(c)(3)	Applies to all notices of exemption pursuant to 14 CCR § 1038
14 CCR § 1038.1(c)(4)(A)	14 CCR § 1038 (d)
14 CCR § 1038.1 (c)(4)(B)	14 CCR § 1038 (e) and (f)
14 CCR § 1038.1(c)(5) through (14)	14 CCR § 1038 (b), (c), (d), (e), (f), and (g)
14 CCR § 1038.1(c)(15)	14 CR § 1038 (a), (b), (c), (d), (e), and (g)

- (1) The notice of exemption shall be prepared, signed, and submitted to the Department by a RPF.
- (2) Upon submission of the notice of exemption, a Confidential Archaeological Letter pursuant to 14 CCR § 929.1 [949.1; 969.1] must be provided to the Director and the RPF shall send a copy of the notice of exemption to Native Americans as defined in 14 CCR § 895.1.
- (3) No Timber Operations on any site that satisfies the criteria listed in 14 CCR § 895.1 for a Significant Archaeological or Historical Site, except under the following conditions:
 - (A) If a Significant Archaeological or Historical Site is identified by the RPF preparing the notice of exemption within the project boundary, the site may be preserved in place by capping or covering

CALIFORNIA FOREST PRACTICE RULES

with a layer of soil prior to submission.

(B) If a site has been preserved in place, the RPF preparing the notice of exemption shall obtain written concurrence from a Department archeologist prior to submission indicating operations will not cause damage to a Significant Archaeological or Historical Site.

(C) The written concurrence from a Department archeologist shall be submitted with the notice of exemption.

(4) Fuel treatments as follows:

(A) Slash within the Harvest Area shall be treated to achieve a maximum post-harvest depth of thirty (30) inches above the ground. All Slash shall be lopped, removed, chipped, piled for burning, or otherwise treated, within one (1) year from the date of the Director receiving the notice except for burning. Burning shall be completed within two (2) years from the date of the Director receiving the notice.

(B) Slash shall be treated to achieve a maximum post-harvest depth of eighteen (18) inches above the ground on at least eighty (80) percent of the Harvest Area. All Slash shall be lopped, removed, chipped, piled for burning, or otherwise treated, within one (1) year from the date of the Director receiving the notice except for burning. Burning shall be completed within two (2) years from the date of the Director receiving the notice.

(5) No tractor or heavy equipment operations on slopes greater than fifty (50) percent. No construction of new tractor roads on slopes greater than forty (40) percent.

(6) Timber Operations within any Special Treatment Area shall comply with the rules associated with that Special Treatment Area.

(7) No tractor or heavy equipment operations on known Unstable Areas.

(8) No new road construction or reconstruction, as determined pursuant 14 CCR § 895.1.

(9) No heavy equipment operations within the standard width of a WLPZ, as determined pursuant to 14 CCR § 916.4 [936.4, 956.4] (b), except for maintenance of roads and Drainage Facilities or structures.

(10) No known sites of rare, threatened or endangered plants or animals will be disturbed, threatened or damaged.

(11) No Timber Operations within the buffer zone of a Sensitive Species.

(12) No timber harvesting within the standard width of a WLPZ, as determined pursuant to 14 CCR § 916.4 [936.4, 956.4] (b), except sanitation-salvage harvesting, as identified within 14 CCR § 913.3 [933.3, 953.3], where immediately after completion of operations, the area shall meet the Stocking Standards of 14 CCR § 912.7 [932.7, 952.7] (b)(2), or, except the removal of dead or Dying trees where consistent with 14 CCR § 916.4 [936.4, 956.4] (b). Trees to be harvested shall be marked by, or under the supervision of, an RPF prior to Timber Operations.

(13) The Director shall notify the submitter of the date of the Director's receipt of the notice of exemption. Timber Operations pursuant to the notice of exemption may not commence for five (5) working days from the date of the Director's receipt of the notice of exemption unless this delay is waived by the Director. If the notice of exemption is not complete and accurate, the Director shall notify the submitter within five (5) working days from the date of the Director's receipt, and the Timber Operations may not commence. The Director shall determine whether the notice of exemption is complete and accurate, and if so, shall send a copy of a notice of acceptance to the submitter; provided, however, if the Director does not act within five (5) working days of receipt of the notice of exemption, Timber Operations may commence.

(A) Timber Operations may not be conducted without a copy of the Director's notice of acceptance of the notice of exemption at the operating site, except where the Director has failed to act within the five (5) working-day review period.

(14) Before beginning Timber Operations, the LTO, RPF, or person responsible for submittal of the notice of exemption shall notify CAL FIRE of the actual commencement date of operations. The notification, by telephone, mail, or email, shall be directed to the appropriate CAL FIRE Unit Headquarters, Forest Practice Inspector or other designated personnel. If the notification is provided by mail, Timber Operations may not commence until three (3) days after the postmark date of notification. The provisions of this paragraph do not supersede the requirements of paragraph (13) above.

(15) No large old trees, defined as a tree that existed before 1800 AD and is greater than sixty (60) inches in diameter at stump height for Sierra or Coast Redwoods, and forty-eight (48) inches in diameter at stump height for all other tree species, or Decadent and Deformed Trees with Value to Wildlife shall be

CALIFORNIA FOREST PRACTICE RULES

harvested unless the following apply:

(A) The tree is not critical for the maintenance of a Late Successional Stand.

(B) A RPF attached to the submitted notice of exemption a written explanation and justification for the harvest of the tree based on the RPF’s finding of any of the following:

1. The tree is a hazard to safety or property.

2. The removal of the tree is necessary for the construction of a building as approved by the appropriate local jurisdiction and shown on the county or city approved site plan, which shall be attached to the submitted notice of exemption.

3. The tree is dead or likely to die within one (1) year of the date of the proposed removal, as determined by a RPF.

(C) An RPF’s written explanation or justification need not be attached to the submitted notice of exemption if an approved Habitat Conservation Plan, Sustained Yield Plan, or Plan addresses large old tree retention for the area in which the large old tree is proposed for removal and the removal is in compliance with the retention standards of that document.

1038.2 Mapping Standards for Notices of Exemption

A submitted notice of exemption shall include a seven-and-one-half (7½) minute USGS quadrangle map, or its equivalent, depicting the information as required in Table 1 below. Additional maps, which may be topographic or planimetric, may be used to provide additional information, to show specific details, and to improve map clarity. A larger scale map such as an assessor parcel map showing the location of the Timber Operations shall be included for exemptions conducted under 14 CCR § 1038 (c). The Appurtenant Roads included within the Logging Area pursuant to subsection (b) below may be shown on a map which may be planimetric with a scale as small as one-half inch equals one mile. Color coding shall not be used. A legend shall be included indicating the meaning of the symbols used. The submitted notice of exemption shall indicate if more than one Yarding system is to be used and identify the systems (if more than one is used).

Table 1: Mapping Requirements

Applicable Mapping Requirements	Notice of Exemption Type(s)
14 CCR § 1038.2 (a)	14 CCR § 1038 (a), (c), and (g)
14 CCR § 1038.2 (b), (c), (k)	14 CCR § 1038 (b), (c)(6), (d), (e), and (f)
14 CCR § 1038.2 (d) through (f)	14 CCR § 1038(c)(6) through (f)
14 CCR § 1038.2 (g), (h), and (j)	14 CCR § 1038 (c)(6), (e), and (f)
14 CCR § 1038.2 (i)	14 CCR § 1038 (b) through (f)
14 CCR § 1038.2 (l)	14 CCR § 1038(f)
14 CCR § 1038.2(m)	14 CCR § 1038(a) through (f)

(a) Boundaries of the Harvest Area.

(b) Boundaries of the Logging Area.

(c) Location of all Roads to be used for, or potentially impacted by, Timber Operations.

(d) The classification of all Roads as Permanent Roads, Seasonal Roads, or Temporary Roads.

(e) Road(s) and Landing(s) located in a Watercourse, Lake, WLPZ, Meadows and Wet Areas other than at road Watercourse crossings.

CALIFORNIA FOREST PRACTICE RULES

- (f) Location of water drafting sites.
- (g) Public Roads within one-quarter (¼) mile of the Harvest Area.
- (h) Location of portions of the Harvest Area with an Extreme Erosion Hazard Rating.
- (i) Location of all Watercourses and Lakes with Class I, II, III or IV waters.
- (j) Location of known Unstable Areas.
- (k) Location of any Special Treatment Areas.
- (l) Location of boundaries of timber-site classes needed for determination of Stocking Standards to be applied, down to at least a twenty (20) acre minimum or as specified in District Forest Practice Rules.
- (m) Boundaries of any areas where Tractor Operations are proposed for use on areas designated for Cable Yarding.

1038.3 Forest Fire Prevention Exemption

Persons who are engaged in the cutting or removal of trees, limited to those trees that eliminate the vertical continuity of vegetative fuels and the horizontal continuity of tree crowns for the purpose of reducing flammable materials to reduce fire spread, duration and intensity, fuel ignitability, or ignition of tree crowns are exempt from the plan preparation and submission requirements (PRC § 4581) and from the completion report and stocking report requirements (PRC §§ 4585 and 4587) of the FPA. Timber Operations conducted under any notice of exemption described herein shall be limited to one (1) year from the date of receipt by the Director, and shall comply with all operational provisions of the FPA and District Forest Practices Rules applicable to “Timber Harvest Plan”, “THP”, and “Plan” definitions per 14 CCR § 895.1. This exemption shall be known as the Forest Fire Prevention Exemption. Preparation and submittal of notices of exemption under this section, or Timber Operations conducted thereunder, shall comply with the following conditions, exceptions, or requirements as described.

(a) Comply with the requirements of Title 14 CCR §§ 1038.1 (c)(5), (6), (7), and (9) through (12) inclusive.

(b) This exemption shall only be used on Timberlands that are within the most recent version of the Department’s Fire Hazard Severity Zone Map, which can be found on the Department’s website: <https://www.fire.ca.gov/>, that shows the exemption will occur in areas determined to be moderate, high and very high fire threat areas.

(c) The Harvest Area shall not exceed three-hundred (300) acres.

(d) (1) Slash and Woody Debris shall be treated to achieve a maximum post-harvest depth of eighteen (18) inches above the ground except within one-hundred-fifty (150) feet from any point of an approved and legally permitted structure that complies with the California Standards Building Code.

(2) All surface fuels within one-hundred-fifty (150) feet of an Approved and Legally Permitted Structure, which could promote the spread of wildfire, shall be chipped, burned, or removed within forty-five (45) days from the start of Timber Operations.

(3) All fuel treatments shall be completed within one (1) year from the date the Director receives the notice. This requirement does not apply to burning, which instead shall be completed within two (2) years from the date the Director receives the notice.

(4) The requirements of this subsection shall not supersede the requirements of PRC § 4291.

(e) The construction or reconstruction of roads, other than Temporary Roads, is prohibited. The construction or reconstruction of Temporary Roads on slopes greater than thirty (30) percent is prohibited. The construction or reconstruction of Temporary Roads on slopes of thirty (30) percent or less shall be allowed if all of the following conditions are met:

(1) Temporary Roads or Landings shall not be located on Unstable Areas.

(2) Temporary Roads shall be single lane in width.

(3) Temporary Roads shall not be located across a Connected Headwall Swale.

(4) Construction or re-construction of Temporary Roads, Landings or Watercourse crossings shall not occur during the Winter Period.

(A) Roads and Landings used for log hauling or other heavy equipment uses during the Winter Period shall occur on a Stable Operating Surface and, if necessary, be surfaced with rock to a depth and quantity sufficient to maintain a Stable Operating Surface. No operation shall be permitted on roads that are not subject to Hydrological Disconnection, or which exhibit Saturated Soil Conditions.

CALIFORNIA FOREST PRACTICE RULES

(B) Timber Operations during the Winter Period shall comply with the applicable Rule sections under 14 CCR § 923 [943, 963] et seq.

(C) Use of Temporary Roads shall comply with the operational provisions of 14 CCR § 923 [943, 963] et seq.,

(D) No Logging Road or Landings construction, or reconstruction, activities shall occur within two-hundred (200) feet of Class I and Class II Watercourses, or within fifty (50) feet of a Class III Watercourse.

(5) Temporary Road construction or reconstruction, shall be limited to no more than two (2) miles of road per ownership within a single Planning Watershed (CALWATER 2.2) per any five (5) year period.

(A) For exemptions that are less than forty (40) acres, all Temporary Roads constructed and/or reconstructed shall not exceed a cumulative length of three-hundred (300) feet.

(B) For exemptions between forty (40) and eighty (80) acres, this standard shall not exceed three-hundred (300) to six-hundred (600) feet, as determined on a pro rata basis by total acreage affected by the exemption.

(C) For exemptions over eighty (80) acres, this standard shall not exceed six-hundred (600) feet.

(D) Temporary Roads constructed or reconstructed under this section shall not be connected to other Temporary Roads constructed under previous or subsequent exemptions filed pursuant to this section.

(E) Prior to completion of Timber Operations, all Temporary Roads constructed or reconstructed under this section shall undergo Abandonment in a manner which uses protective measures that will effectively remove them from the Permanent Road Network, as defined in 14 CCR § 895.1.

(F) No tree larger than thirty-six (36) inches in diameter at stump height, measured eight (8) inches above ground level, shall be removed for the purposes of Temporary Road construction or reconstruction as it applies to this exemption. Trees between thirty (30) and thirty-six (36) inches in diameter at stump height, measured eight (8) inches above ground level, may be removed for the purposes of Temporary Road construction or reconstruction when no other feasible option exists for Temporary Road construction activities.

(f) The RPF responsible for submission of the notice of exemption shall designate Temporary Road locations, Landing locations, Tractor Road crossings of Class III Watercourses, Unstable Areas, or Connected Headwall Swales on the ground prior to submission of the notice of exemption.

(g) The QMD of trees greater than eight (8) inches dbh in the Harvest Area shall be increased in the post-harvest stand. The submitted notice of exemption shall report the expected post-harvest increase in QMD.

(h) Except within constructed or reconstructed Temporary Road prisms, only trees less than thirty (30) inches in stump diameter, measured eight (8) inches above ground level, may be removed.

(i) All trees that are harvested or all trees that are retained shall be marked or sample marked by, or under the supervision of, an RPF before felling operations begin. Sample marking shall be limited to homogeneous forest stand conditions typical of plantations. When trees are sample marked, the prescription for unmarked areas shall be in writing and the sample mark area shall include at least ten (10) percent of the harvest area to a maximum of twenty (20) acres per stand type which is representative of the range of conditions present in the area.

(j) If the preharvest crown canopy of Dominants and Codominants is occupied by trees less than fourteen (14) inches in dbh, a minimum of one-hundred (100) trees over four inches in Diameter at breast height shall be retained per acre for Site I, II, and III lands, and a minimum of seventy-five (75) trees over four inches in Diameter at breast height shall be retained per acre for Site IV and V lands.

(k) The following canopy, retention, and spacing standards shall be achieved on at least eighty (80) percent of the Harvest Area:

(1) Minimum post treatment canopy closure shall comply with the standards of 14 CCR § 1052.4 (d)(3)(A)

(2) Post treatment stand shall contain no more than two-hundred (200) trees per acre over three (3) inches in dbh.

(3) Vertical spacing shall be achieved by treating dead fuels, excluding dead branches on the trees retained for stocking, to a minimum clearance distance of eight (8) feet measured from the base of the live

CALIFORNIA FOREST PRACTICE RULES

crown of the post-harvest Dominants and Codominants to the top of the dead surface or ladder fuels, whichever is taller.

(l) Helicopter Yarding shall be prohibited.

(m) The RPF shall comply with 14 CCR § 1035.2, relating to interaction between the LTO and the RPF.

(n) All Timber Operations conducted in the Lake Tahoe Region, if applicable, must have a valid Tahoe Basin Tree Removal Permit (as defined by the TRPA) or shall be conducted under a valid TRPA Memorandum of Understanding, when such a permit is required by TRPA.

(o) Upon submission of the notice of exemption, a Confidential Archaeological Letter pursuant to 14 CCR § 929.1 [949.1; 969.1] must be provided to the Director and the RPF shall send a copy of the notice of exemption to Native Americans as defined in 14 CCR § 895.1.

(p) No Timber Operations on any site that satisfies the criteria listed in 14 CCR § 895.1 for a Significant Archaeological or Historical Site may be conducted (information on some of these sites may be available from the Information Centers of the California Historical Resources Information System within the Department of Parks and Recreation),

(q) If a notice of exemption has been accepted by the Director and will use pesticides or herbicides on the Harvest Area within one (1) calendar year of the date of acceptance, the timberland owner shall notify the appropriate regional water quality control board within ten (10) days prior to application of pesticides or herbicides.

(r) Subsequent to the completion of Timber Operations operating under this section, the Department shall conduct an onsite inspection to determine compliance with this section. The Department shall notify the appropriate RWQCB, the CDFW, and the CGS seven (7) days prior to conducting the onsite inspection.

(s) The notice of exemption shall be prepared by, signed, and submitted by an RPF. The RPF shall be retained to oversee all construction or reconstruction of Roads and/or Landings, and provide for necessary mitigation to avoid potential impacts.

(t) The notice of exemption shall be submitted to the Director, on a form provided by the Department, prior to the commencement of Timber Operations. The form shall contain the following information:

(1) Name(s), address, and telephone number(s) of the Timber Owner(s), timberland owner(s), and Timber Operator.

(2) Name, address, and telephone number and license number of the RPF preparing and submitting the notice of exemption.

(3) Legal description of the location of the Timber Operations.

(4) The tentative date of commencement of Timber Operations.

(5) A signature of the landowner certifying that they are the landowner and have read and understand the information contained within the notice of exemption.

(6) A description of preharvest stand structure; and

(7) An estimate of pre and post-harvest QMD and certification by the RPF that, in their professional judgment, post-harvest slash treatment and stand conditions will lead to more moderate fire behavior.

(u) The RPF shall, upon submission of the notice of exemption:

(1) Certify that the level of residual Stocking shall be consistent with maximum sustained production of high quality timber products. The residual stand shall consist primarily of healthy and vigorous Dominants and Codominants from the preharvest stand. Trees retained to meet the Basal Area stocking standards shall be selected from the largest trees available on the project area prior to harvest. In no case shall stocking be reduced below the standards found within 14 CCR § 913.3 [933.3, 953.3] (a).

(2) Affirm that the construction or reconstruction of each Temporary Road is necessary to provide access to Harvest Areas when no other feasible alternative exists. The notice shall include the total number of and cumulative length of Temporary Roads being constructed and/or reconstructed.

(3) Provide the selection criteria for the trees to be removed or the trees to be retained. In the development of these criteria, and the fuel reduction prescriptions, the RPF should consider retaining habitat elements, where feasible, including, but not limited to, ground level cover necessary for the long-term management of local wildlife populations. The selection criteria shall specify how the trees to be removed, or how the trees to be retained, will be designated.

(v) The Director shall notify the submitter of the date of the Director's receipt of the notice of exemption.

CALIFORNIA FOREST PRACTICE RULES

Timber Operations pursuant to the notice of exemption may not commence for ten (10) working days from the date of the Director's receipt of the notice of exemption unless the delay is waived by the Director. If the notice of exemption is not complete and accurate, the Director shall notify the submitter within five (5) working days from the date of the Director's receipt, and the Timber Operations may not commence. The Director shall determine whether the notice of exemption is complete and accurate, and if so, shall send a copy of a notice of acceptance to the submitter; provided, however, if the Director does not act within ten (10) working days of receipt of the notice of exemption, Timber Operations may commence. Timber Operations may not be conducted without a copy of the Director's notice of acceptance of the notice of exemption at the operating site, except where the Director has failed to act within the ten (10) working-day review period.

(1) Upon receipt of the submitted notice of exemption, the Director shall place it, or a true copy thereof, in a file available for public inspection, and shall transmit a copy to the CDFW, the appropriate RWQCB, and the CGS.

(w) Before beginning Timber Operations, the RPF responsible for submittal of the notice of exemption shall notify the Department, the appropriate RWQCB, the CDFW, and the CGS of the actual commencement date of operations. The notification, by telephone, mail, or email, shall be directed to the appropriate agency personnel and contact information for the appropriate agency personnel shall be provided by the Department on the notice of exemption form. If the notification is provided by mail, Timber Operations may not commence for three (3) days after the postmark date of notification.

(x) This subsection will expire five (5) years after February 19, 2019.

1038.4. Mapping Standards for the Forest Fire Prevention Exemption

An exemption pursuant to this 14 CCR § 1038.4 will be mapped on a USGS 7 ½ minute quadrangle map, or equivalent topographic maps, and shall contain all required information stated within this section. Additional maps, which may be topographic or planimetric, may be used to provide the information required in this section, to show specific details, and to improve map clarity. Appurtenant Roads may be shown on a separate map which may be planimetric with a scale as small as one-half inch equals one mile. Color coding may not be used. A legend shall be included indicating the meaning of symbols used.

(a) Boundaries of the Logging Area

(b) Boundaries of Yarding (logging) systems, if more than one system is used.

(c) Location of all roads to be used for, or potentially impacted by, Timber Operations. This shall include:

(1) The classification of all roads as proposed, Permanent, Seasonal, Temporary, Deactivated, or proposed for Abandonment.

(2) Roads and Landings located in Watercourses, Lakes, WLPZs, marshes, Wet Meadows and Other Wet Areas, other than at road Watercourse crossings.

(3) Logging Roads that provide access to rock pits and water drafting sites, and the location of water drafting sites.

(4) Public Roads within one-quarter (1/4) mile of the Harvest Area.

(5) The location of Significant or Existing Potential Erosion Sites on all roads and Landings pursuant to 14 CCR § 923.1 (e).

(d) For all constructed and reconstructed Temporary Roads and Landings, the following shall be mapped:

(1) Location of Temporary Road grades greater than fifteen (15) percent for over two-hundred (200) continuous feet or Logging Roads grades exceeding twenty (20) percent.

(2) Location of Road Failures on existing Temporary Roads to be Reconstructed.

(3) Location of Landings, specifying those that require substantial excavation and those in excess of one-quarter acre in size.

(4) Location of excess material disposal sites on slopes greater than forty (40) percent or on active Unstable Areas.

(e) Location of all Tractor Road Watercourse crossings of classified Watercourses.

(f) Location of Erosion Hazard Ratings, if more than one rating exists.

(g) Location of Watercourses and Lakes with Class I, II, III, or IV waters.

(h) Location of known Unstable Areas.

(i) Location of understocked areas prior to Timber Operations, and other areas not normally bearing timber

CALIFORNIA FOREST PRACTICE RULES

to at least a 20-acre minimum, or as specified in the district rules.

(j) Location of boundaries of timber-site classes needed for determination of Stocking Standards to be applied, down to at least a twenty (20) acre minimum, or as specified in the District Rules.

(k) Location of any Special Treatment Areas.

(l) Boundaries of any areas where Tractor Operations are proposed for use on areas designated for Cable Yarding.

1038.9 Agency Exemptions

The following types of Timber Operations are exempt from the provisions of the Z'berg-Nejedly Forest Practice Act, (PRC division 4, part 2, chapter 8 - beginning at § 4511) but not exempt from the Professional Foresters Law, PRC § 750 et. seq.

(a) Timber Operations on land managed by the California Department of Parks and Recreation, provided the Timber Operations have undergone all CEQA evaluation required pursuant to PRC division 13, beginning at § 21000.

(b) Timber Operations performed by, or authorized by, federal agencies on private lands where federal easements, either partial interest or in fee, have been acquired, provided such activities are analyzed and conducted pursuant to the National Environmental Policy Act (beginning at 42 U.S.C. 4321) and achieve the same level of protection as provided by the Rules of the Board in California Code of Regulations, Title 14, division 1.5 (beginning with § 895).

1039 Amendment

Amendments proposing substantial deviation from an original plan shall be submitted to the Director in writing by the person who submitted the original plan, or the successor in interest. Substantial deviations shall not be undertaken until such amendment has been filed and acted upon by the Director in the manner as required in Article 2 of Subchapter 7 of these Rules for the original plan.

1039.1 Effective Period of the Plan

The effective period of the plan within the meaning of PRC §§ 4590 and 4591 is the five (5)-year period following the date the plan is determined to be in conformance or otherwise becomes effective pursuant to PRC § 4582.7. Timber Operations shall commence no earlier than the expected date of commencement stated in the plan and shall be completed no later than the expected date of completion stated in the plan except under the following conditions:

(a) An amendment to change the completion date stated in a plan has been submitted to the Director at least ten days before the expected date of completion.

(b) An amendment to extend the effective period of a plan beyond five (5) years is submitted in compliance with PRC § 4590, which includes a map showing clearly the area pertaining to the request for extension.

Upon receipt of such amendment, the Director shall determine whether the change in date constitutes a substantial deviation of the plan. An extension of time is presumed to be a minor deviation, provided the extension does not lead to practices that constitute a substantial deviation, as defined in 14 CCR § 895.1. If the Director determines that such change of date constitutes a substantial deviation, then the Director shall, prior to the date to be changed, so notify the person submitting the plan. In this case, an amended plan shall be submitted and no Timber Operations shall be conducted pursuant to such proposed change until such amendment is found in conformance with PRC § 4582.7.

1040 Report Minor Deviations

Minor deviations may be undertaken by the person who submitted the plan without submission of an amendment to the plan and shall be reported immediately in writing to the Director.

Actions described in 14 CCR 895.1 which are normally presumed to be substantial deviations may, in a given instance, be minor deviations. Actions listed as substantial deviations in 14 CCR 895.1 but considered to be minor by the submitter, may be undertaken only if the person who submitted the plan submits the proposed deviation in writing to the Director for review and receives approval. Approval shall be given if the Director determines that the proposed minor deviation conforms to the standards provided in 14 CCR 895.1. The Director shall have five (5) working days to act on the application. If the Director or the Director's

CALIFORNIA FOREST PRACTICE RULES

representative does not act within five (5) working days of receipt of such a deviation, Timber Operations may commence pursuant to such amendment.

1041 Limitations

A plan shall be limited to an area with reasonably similar timber, geology, soil, topography, climate, and Stream characteristics that would constitute a logical harvesting unit. A plan should be limited to that area on which Timber Operations normally will be completed in one 12-month period, but in no case shall it extend beyond five (5) years after the plan is determined to be in conformance or otherwise becomes effective under PRC § 4582.7. Plans shall be limited to lands within a particular forest district.

1042 Change of Ownership

Any change in ownership of land or timber must be reported to the Director if such a change occurs after a plan is filed but before a report of satisfactory completion of stocking is issued by the Director. It shall be the responsibility of the Timber Owner and/or Timberland Owner listed in the plan to notify the Director of the change of either ownership. Also, before the passage of title, it shall be the responsibility of the seller to notify the purchaser of either the timber or Timberland of their responsibility for compliance with the stocking standards of the Act and the Rules of the Board.

After a plan is found in conformance with the Rules and regulations of the Board, the Director may file a Notice of Stocking Requirements on the property with the recorder of the county within which the plan is located. When a report of satisfactory stocking is issued by the Director, a Notice of Compliance will be sent to the Timberland Owner.

1043 Cancellation of Plans

All parties, who submitted plan or their successors, must sign the request to the Director for cancellation of a plan. Once cutting has commenced, the plan may not be canceled except as to lands not harvested.

1045 Director Delegation

In order to expeditiously process plans, the Director may make such delegations deemed to be fit to employees of the Department, qualified as RPFs pursuant to Article 3 of Chapter 2.5 of Division 1 of the PRC (commencing with Sec. 750).

1050 Erosion Control Maintenance

(a) Where necessary to minimize soil erosion or slope instability or to prevent degradation of the quality and beneficial uses of water, the department may require that erosion controls be maintained prior to the beginning of a winter period and prior to filing of a work completion report.

(b) The Director may deem completion report as described in PRC 4585 to have been filed upon the date of receipt if the Department finds that all erosion controls have been constructed and maintained in compliance with the Forest Practice Rules upon the first inspection after receipt of the completion report. Otherwise, the Director shall accept a work completion report for filing only after the Department finds that all erosion controls have been constructed in compliance with the Forest Practice Rules.

(c) The LTO is responsible for proper construction, inspection and maintenance of erosion control during the prescribed maintenance period until the work completion report as described in PRC 4585 is approved by the Director. The landowner is responsible for inspection and any needed repair and maintenance of erosion controls during the remainder of the prescribed maintenance period. Responsibility for erosion control maintenance may be assumed at an earlier date by the landowner or can be delegated to a third party, provided that the assuming party acknowledges such responsibility in writing to the Director.

(d) Upon approving a work completion report, the Director may prescribe a maintenance period which extends for as much as three years after filing the work completion report based on physical evidence (such as location of erosion controls in disturbed areas with high or extreme erosion hazard, on steep or unstable slopes, or within or adjacent to the standard width of a water course or lake protection zone) that erosion controls need to be maintained for the extended maintenance period in order to minimize soil erosion or slope instability or to prevent degradation of the quality and beneficial uses of water.

(e) After approving the work completion report, the Director may extend the prescribed maintenance

CALIFORNIA FOREST PRACTICE RULES

period for as much as three years after filing of the work completion report if subsequent inspections by the department during the prescribed maintenance period show that erosion controls have failed or are likely to fail to minimize soil erosion or slope instability or to prevent degradation of the quality and beneficial uses of water.

1051 Modified THP

(a) On an ownership of 160 acres, or a quarter (¼) section or less of Timberland, a modified timber harvest plan may be filed by a plan submitter, providing that the following conditions and mitigations are met:

(1) No more than 70% of any existing tree canopy layer is to be harvested on parcels 40 acres or less, and not more than 50% on parcels 41-160 acres, or a quarter (¼) section. The canopy retained shall be well distributed over the harvest area. Not more than 10% of the THP area shall be harvested under the rehabilitation method. A sample area must be marked before submission of the THP. The sample area shall include at least 10% of the area which is representative of the range of conditions present in the area.

(2) Clearcutting and shelterwood removal, as defined in 14 CCR 913.1(a) [933.1(a), and 953.1(a)] shall not be used, except for legally deeded rights-of-way or easements for utility purposes which are documented in the plan by the RPF by reference to specific deeds or surveys.

(3) Stocking standards, specific to the silvicultural method selected, must be met immediately after harvesting operations are completed.

(4) No heavy equipment operations on slopes greater than 50%, or on areas with high or extreme erosion hazard ratings, except where explained and justified how the protection provided by the proposed practice complies with 14 CCR § 914 [934, 954].

(5) No construction of new skid trails on slopes over 50%. Construction of new skid trails on slopes greater than 40% and less than 50% shall not exceed 100 feet. The proposed location of such skid trails shall be clearly depicted on the THP map and flagged or otherwise identified on the ground by the RPF or supervised designee prior to the start of operations.

(6) Timber Operations within Special Treatment Areas shall be limited to log hauling on existing Logging Roads and/or other operations consistent with the intent and purpose of the Special Treatment Area as approved by the Director.

(7) No Timber Operations shall occur on slide areas or unstable areas except for use and Maintenance of existing Logging Roads and Landings that do not require reconstruction.

(8) Where the THP area is 100 acres or less, new Logging Road construction shall not exceed a total of 600 feet and Logging Road construction and reconstruction combined shall not exceed a total of a 1,000 feet. Where a THP area is greater than 100 acres, new Logging Road construction shall not exceed a total of 960 feet, and Logging Road construction and reconstruction combined shall not exceed a total of 1,600 feet.

(9) No heavy equipment operations shall occur within a Watercourse or lake protection zone, or Wet Meadows and Other Wet Areas, except as follow:

(A) For maintenance of existing Logging Roads, drainage facilities or structures, or

(B) For logging and tractor road Watercourse crossing construction or reconstruction

approved by the California Department of Fish and Wildlife (CDFW) through notification required pursuant to F&GC § 1602.

(10) No listed species will be directly or indirectly adversely Impacted by proposed Timber Operations. For Timber Operations which potentially could adversely affect a State-listed species or the habitat of the species, the consultation process with CDFW pursuant to F&GC shall be completed prior to plan approval.

(11) Timber harvesting is only allowed in the WLPZ if: 1) sanitation-salvage harvesting is the only silvicultural system to be used in the WLPZ and it must be in compliance with 14 CCR 916.4(b) [936.4(b), 956.4(b)]; or 2) if harvesting removes no more than 30% of any existing canopy layer. Harvesting under 2) above shall not occur again in the WLPZ for a 10-year period following completion of the THP.

(12) No heavy equipment operations shall occur within potentially significant archaeological sites identified pursuant to the criteria for a significant archaeological or historical site listed in 14 CCR § 895.1. Directional felling and tree removal by end-lining and Cable Yarding may be approved upon the Director's determination that such operations will not adversely affect an identified archaeological site.

CALIFORNIA FOREST PRACTICE RULES

(13) No alternatives, exceptions, or in-lieu practices allowed for Watercourse or lake protection measures, standard Logging Road and Landing widths, or erosion control measures, except for use of existing Logging Roads within WLPZ after compliance with examination, evaluation, and mitigation(s) per 14 CCR 916.4(a) [936.4(a), 956.4(a)].

(14) Winter period Timber Operations except as conditioned by the Director to avoid potential significant cumulative Impacts shall be in accordance with 14 CCR 914.7 (a) and (b) [934.7 (a) and (b), 954.7(a) and (b)].

(15) Harvesting will not reduce the amount of Timberland occupied by late succession forest stands currently greater than or equal to 5 acres in size.

(16) In addition to (1)-(15) all other Rules of the Board shall apply to operations specified in this section.

1051.1 Contents of Modified THP

A plan submitted under 14 CCR § 1051 above shall contain all the applicable provisions of 14 CCR § 1034 and the RPF shall:

(a) Identify and map those areas currently understocked and not to be harvested that are at least three acres in size.

(b) Use a topographic map base with a minimum scale of 1:12,000.

(c) Certify in the THP that the conditions or facts stated in items 1-16 above exist on the THP area at the time of submission, and that in the preparation, mitigation, and analysis of the THP, no identified potential significant effects remain undisclosed.

(d) Certify that a meeting will be held at the THP site before Timber Operations commence with the RPF responsible for the plan or supervised designee and the licensed Timber Operator who will be operating on the THP where the contents and implementation of the plan have been reviewed and discussed. Operations pursuant to this section shall use an alternative to the cumulative Impacts assessment specified in 14 CCR 898, 912.9 [932.9, 952.9], and Technical Rule Addendum No.2. Operations conducted according to this section are presumed to be unlikely to cause a significant adverse Impact to the environment due to the specific restrictive mitigations required in (1)-(15) above.

This presumption of unlikely Impacts shall not apply to THPs for which: 1) the Director determines it does not meet the criteria of subsection (a), or 2) the Director determines in consultation with trustee or responsible agencies, or upon review of public comments that a fair argument exists that significant individual or cumulative Impacts will result from Timber Operations. Where issues (a fair argument) are raised the RPF shall complete the appropriate portion of Technical Rule Addendum No. 2 and submit that information for the Director's review.

1051.2 Review of Modified THP

The Director shall require a preharvest inspection of modified timber harvest plans when substantial question by Review Team members exist on plan contents or environmental Impacts, and where winter operations are proposed according to 914.7 (a) and (b) [934.7(a) and (b), 954.7 (a) and (b)].

1051.3. Modified THP for Fuel Hazard Reduction.

The purpose of 14 CCR §§ 1051.3-1051.7 is to encourage forest landowners to consistently manage vegetation to create fire resilient conditions, and reduce the threat, and potentially deleterious effects of unmanaged fire. These fire resilient conditions are to be achieved through the prescribed reduction and spatial rearrangement of surface and ladder fuels as well as thinning to reduce stocking levels and increase vertical and horizontal spacing between standing stems. Operations pursuant to 14 CCR §§ 1051.3-1051.7 are expected to result in project area conditions that reduce the rate of fire spread, duration and intensity of a fire, fuel ignitability, and ignition of tree crowns.

14 CCR §§ 1051.3-1051.7 provides for the utilization of intermediate treatments and special prescriptions, and is not intended to support even-aged or uneven-aged regeneration methods. Surface and ladder fuel reduction is the primary focus of 14 CCR §§ 1051.3-1051.7 rather than overstory removal of dominant and codominant trees.

In addition to the standards prescribed in 14 CCR §§ 1051.3-1051.7, all other Rules of the Board adopted

CALIFORNIA FOREST PRACTICE RULES

pursuant to the Administrative Procedures Act and applicable to Timber Harvesting Plans shall likewise apply to operations conducted under a Modified THP for Fuel Hazard Reduction.

1051.4. Modified THP for Fuel Hazard Reduction Conditions and Mitigations.

(a) A Modified THP for Fuel Hazard Reduction (hereafter also referred to as “MTHP-FHR”) may be filed by a plan submitter for a project area not to exceed 2,500 acres, providing that the following conditions and mitigations are met:

(1) An average of at least 40% of the existing overstory tree canopy shall be retained. The canopy retained shall be well distributed over the harvest area.

(2) Prescribed fuel hazard reduction to promote project area resiliency to wildfire is recognized as an intermediate treatment rather than a regeneration method. Therefore, clearcutting as defined in 14 CCR §§ 913.1(b), 933.1(b), and 953.1(b) shall not be used, except for legally permitted utility corridors or road construction. Silvicultural methods that may be used are commercial thinning pursuant to 14 CCR §§ 913.3(a), 933.3(a), and 953.3(a), rehabilitation as constrained by 14 CCR §§ 1051.3-1051.7 and pursuant to 14 CCR §§ 913.4(b), 933.4(b), and 953.4(b), and fuelbreak/defensible space pursuant to 14 CCR §§ 913.4(c), 933.4(c), and 953.4(c).

(3) Stocking standards, specific to the silvicultural method selected, must be met immediately after harvesting operations are completed, except as explained and justified for specific instances where the rehabilitation method is proposed and will result in post-harvest stands that cannot meet stocking standards.

(4) The rehabilitation method may be used where understocked areas such as brushfields have been identified for treatment in a federal, state, or local fire plan document for the purpose of reducing fire risk to a public asset including, but not limited to, transportation corridors and utilities, or is adjacent to a community listed in the “California Fire Alliance List of Communities at Risk” (available at <https://bof.fire.ca.gov/media/0x5eysuw/ada-communities-at-risk.pdf>). Not more than 10% of the MTHP-FHR area, not to exceed 250 acres, may be harvested under the rehabilitation method, when explained and justified by the RPF and approved by the Director.

(5) No operations shall occur in areas having average slopes greater than 50% based upon sample areas that are 20 acres in size, and no tractor operations in areas with high or extreme erosion hazard ratings.

(6) No construction of new skid trails shall occur on slopes over 40%.

(7) The following operations may occur in Special Treatment Areas: log hauling on existing roads not requiring reconstruction, and other operations as approved by the Director where such operations are consistent with the intent and purpose of the Special Treatment Area.

(8) No Timber Operations shall occur on slide areas or unstable areas.

(9) Timber harvesting in a Class II WLPZ for a Watercourse that is dry by July 15 of any year may be proposed by the RPF and approved by the Director. When proposed, the RPF shall explain and justify the treatment, and provide a written analysis of the potential for significant adverse effects to the Class II WLPZ that could result from the proposed operations. The focus of Class II WLPZ treatments shall be removal of surface and ladder fuels, and no less than 70% of the existing overstory canopy layer shall be retained. Unless explained and justified, retention of the overstory canopy layer shall be accomplished by leaving the existing larger dominant and codominant trees.

(A) No tractor operations shall occur within a Class II WLPZ, or Wet Meadows and Other Wet Areas, except where the Director determines that the threat of catastrophic wildfire is sufficient to justify the

necessity of operations, or for maintenance of existing roads, drainage facilities or structures. Where the Director has made such a determination, operations may only occur where the Erosion Hazard Rating (EHR) pursuant to 14 CCR §§ 912.5, 932.5, and 952.5 is Moderate or less and slopes are no greater than 30%,

(B) Tree removal by end-lining or other low-Impact tree removal methods shall be permitted in the standard width of a Class II WLPZ provided that the plan contains a description of specific mitigation measures designed to minimize disruption of the soil surface, soil compaction, and damage to residual vegetation. Low-Impact tree removal techniques include, but are not limited to, the use of low-ground pressure logging equipment.

(C) The use of existing roads within a Class II WLPZ may be approved by the Director after compliance with the requirements for examination, evaluation, and mitigation(s) per 14 CCR §§ 916.4(a),

CALIFORNIA FOREST PRACTICE RULES

936.4(a), and 956.4(a).

(10) No listed species will be directly or indirectly adversely Impacted by proposed Timber Operations. Except as modified herein, all other habitat protection and retention requirements identified in Articles 6 and 9 of the Forest Practice Rules shall apply. Where the Director has determined that Timber Operations as proposed are likely to adversely affect a state listed species or its habitat, the consultation process with CDFW pursuant to F&GC § 2081 shall be completed before the MTHP-FHR may be approved.

(11) As part of the pre-harvest project design, the RPF shall evaluate and incorporate habitat requirements for fish, wildlife, and plant species in accordance with the “Joint Policy on Hardwoods” between the California Board of Forestry and Fire Protection and the California Fish and Game Commission” (rev. April 1999), herein incorporated by reference, and 14 CCR §§ 916.9, 936.9, and 956.9 and §§ 919, 939, and 959. Such evaluations shall include use of the California Natural Diversity Database maintained by CDFW (available at <https://www.wildlife.ca.gov/Data/CNDDDB>) and local review agency knowledge of the planning watershed. Consultation with CDFW personnel is recommended.

In general, fuels management strategies should recognize that habitat heterogeneity and fire resiliency are not mutually exclusive. Habitats and habitat elements may include key winter range or migration routes, late successional stands, hardwood or aspen groves, Riparian or wetland areas, snags, large down woody material, or den trees.

(A) Harvesting will not reduce the amount of Timberland occupied by late succession forest stands.

(B) Where present prior to operations, the following habitat elements shall be retained as an average across the project area:

1. A minimum of 2 large live cull (green) conifer trees 24” dbh or larger per acre;
2. A minimum of two hardwood trees 24” dbh or larger per acre;
3. A minimum of two downed logs 20” diameter outside bark as measured at the midpoint of the total length of the log or larger per acre; and
4. 2% shall be left as untreated habitat retention surrounding or in direct proximity to the habitat elements identified in 1, 2, and 3 above.

(12) No heavy equipment operations shall occur within potentially significant archaeological sites identified pursuant to the criteria for a significant archaeological or historical site listed in 14 CCR § 895.1. Directional felling and tree removal by end lining may be approved upon the Director’s determination that such operations will not adversely affect an identified archaeological site.

(13) Winter Timber Operations, except as conditioned by the Director to avoid potential significant cumulative Impacts, shall be in accordance with 14 CCR §§ 914.7(a) and (b), 934.7(a) and (b), and 954.7(a) and (b).

1051.5 Contents of Modified THP for Fuel Hazard Reduction.

A plan submitted under section 14 CCR § 1051.3 above shall contain all the provisions of 14 CCR § 1034 except 14 CCR § 1034(z) and the RPF shall:

- (a) Use a topographic map base with a minimum scale of 1:12,000.
- (b) Certify in the MTHP-FHR that the conditions or facts stated in items 14 CCR § 1051.4(a)(1)-(13) above exist on the MTHP-FHR area at the time of submission, and that in the preparation, mitigation, and analysis of the MTHP-FHR document, no identified potential significant effects remain undisclosed.
- (c) Certify that a meeting will be held at the MTHP-FHR site before Timber Operations commence with the RPF responsible for the plan, or supervised designee, and the licensed Timber Operator who will be operating on the MTHP-FHR area where the contents and implementation of the plan have been reviewed and discussed.
- (d) Certify in writing that in developing the MTHP-FHR, the RPF has completed a cumulative Impacts assessment as specified in 14 CCR § 898 and Technical Rule Addendum No. 2, 14 CCR §§ 912.9, 932.9, and 952.9. Operations conducted pursuant to this section are presumed to be unlikely to cause a significant adverse Impact to the environment due to the specific restrictive mitigations required in 14 CCR § 1051.4(a)(1)-(13) above. This presumption of unlikely Impacts shall not apply to MTHP-FHR for which: 1) the Director determines it does not meet the criteria of subsection 14 CCR § 1051.4(a), or 2) the Director

CALIFORNIA FOREST PRACTICE RULES

determines in consultation with trustee or responsible agencies, or upon review of public comments that a fair argument exists that significant individual or cumulative Impacts will result from Timber Operations. Where a fair argument is raised, the RPF shall complete the appropriate corresponding portion of Technical Rule Addendum No. 2, 14 CCR §§ 912.9, 932.9, and 952.9 and submit that information for the Director's review.

(e) Develop and document the vegetation treatments necessary to meet the objectives of fuel hazard reduction and increased resiliency to wildfire within the project area. The RPF shall utilize contemporary sources of technical information in the development of fuel treatment prescriptions.

Prescriptions shall increase landscape heterogeneity, reduce surface and ladder fuels, and maintain or increase residual quadratic mean diameter. The RPF should be aware of the importance of topography and slope position in the designation of treatment areas. Within stands, important topographic features include sinks, areas susceptible to cold air drainage, and moist microsites. Documentation prepared by the RPF shall include, but not be limited to:

(1) A description of the assets at risk to catastrophic wildfire that are to be protected through the fuel treatments proposed. As feasible and appropriate, the RPF shall attempt to coordinate the objectives of the MTHP-FHR with larger-scale, federal, state, and local strategic fuel treatment and fire prevention plans, including but not limited to the "2010 Strategic Fire Plan for California" (rev. June 2010, available at <https://bof.fire.ca.gov/media/0yeg2vnm/ada-2010-strategic-fire-plan-for-california.pdf>), herein incorporated by reference.

(2) A description of pre-harvest stand structure and stocking levels and silvicultural prescription for achieving the desired post-harvest stand structure and stocking levels.

(3) A description of the timeline, methods and standards for treatment of pre-existing surface and ladder fuels as well as logging Slash created by Timber Operations. The description shall include discussion of the performance standard to be achieved and the methods by which compliance with that performance standard may be verified. The description shall include, but not be limited to, the United States Forest Service "Natural Fuels Photo Series" (rev. April 2011, available at http://www.fs.fed.us/pnw/fera/publications/photo_series_pubs.shtml), incorporated by reference herein, and, in particular, photo series "General Technical Report (GTR) PNW-5 1 (rev. 1976), PNW-52 (rev. 1976), PNW-56 (rev. 1981), and PNW-95" (rev. 1979) incorporated by reference herein, for visual demonstration of pre and post-treatment stand conditions in this description (copies of all four General Technical Reports are available upon request from the State Board of Forestry and Fire Protection located at the State of California Resources Building, 715 P Street, Sacramento, California 95814 or, P.O. Box 944246, Sacramento, California 94244-2460).

(A) While surface and ladder fuel treatment standards will vary based upon site specific conditions, post-treatment total surface fuel loading shall not exceed an average of 25 bone dry tons per acre.

(4) A plan for pre and post-treatment photo point monitoring for the purpose of characterizing the project treatment effects. All photo points shall be mapped and designated on the ground by stake, post, or other equivalent semi-permanent methods. Post-treatment photo point monitoring shall occur prior to expiration of the MTHP-FHR. Post-treatment photos shall be included with the submission of a final report of stocking and work completion.

1051.6. Review of Modified THP for Project Area Fuel Hazard Reduction.

The Director may require a pre-harvest inspection of a MTHP-FHR when Review Team members identify questions specific to a resource concern pursuant to 14 CCR § 1037.5(g).

1051.7. Evaluation of Regulations.

14 CCR §§ 1051.3-1051.7 shall be subject to review by the Board no later than five years from the effective date. Prior to this review, the Board in consultation with the Director shall convene a panel of technical experts to evaluate the efficacy of 14 CCR §§ 1051.3-1051.7 and report their findings. The Department shall report to the Board at least once annually on the use and effectiveness of 14 CCR §§ 1051.3-1051.7 for as long as these rule sections remain effective.

1052 Emergency Notice

CALIFORNIA FOREST PRACTICE RULES

(a) Before cutting or removing timber on an emergency basis, an RPF on behalf of a Timber Owner or operator shall submit a Notice of Emergency Timber Operations to the Director, on form RM-67 (1/1/10), form RM-65 (1052.4)(2/2020) for a Fuel Hazard Reduction emergency, or form RM-66 (1052.5) (2/1/11) for a Sudden Oak Death emergency, herein incorporated by reference, as prescribed by the Director. The notice shall include, but not be limited to, the following:

- (1)** Names and addresses of all Timberland Owner(s), Timber Owner(s), and Timber Operator(s) for the area on which timber will be cut or removed.
- (2)** A description of the specific conditions that constitute the emergency, its cause, extent and reason for immediate commencement of Timber Operations.
- (3)** Legal description of the area from which timber will be cut or removed.
- (4)** A titled USGS (if available) or equivalent topographic map(s) of scale not less than 2" to the mile, or larger scale, showing the Harvest Area, the legal description, Logging Roads and Class I, II, III and IV Watercourses, Yarding systems if more than one will be used, and boundaries of areas where Tractor Operations are proposed for use on areas designated for Cable Yarding. For Timber Operations conducted pursuant to 14 CCR § 1052.4 within those areas described by 14 CCR § 1052.4(c)(2)(A)-(F), the map(s) shall include those features described within 14 CCR § 1052.4(c)(2)(A)-(F), as appropriate.
- (5)** Yarding system to be used.
- (6)** The expected dates of commencement and completion of Timber Operations.
- (7)** A declaration by the RPF, made under penalty of perjury, that a bona fide emergency exists which requires emergency Timber Operations.
- (8)** A declaration by the Timber Owner, made under penalty of perjury, that any applicable timber yield taxes will be paid pursuant to Section 38115 of the Revenue and Taxation Code.
- (9)** Name, address, license number, and signature of the RPF who prepares the notice and submits it to the Director on behalf of the Timber Owner or operator.

(10) For Emergency Notices covering three acres or more in size, the RPF shall include a Confidential Archaeological Letter with the Emergency Notice submitted to the Director. The Director shall also submit a complete copy of the Confidential Archaeological Letter and two copies of any required archaeological or historical site records, to the appropriate Information Center of the California Historical Resource Information System within 30 days from the date of Emergency Notice submittal to the Director.

(A) For Projects filing an emergency notice for fuel hazard reduction under 14 CCR § 1052.4, archaeology requirements shall be conducted by a person possessing current certification pursuant to 14 CCR § 929.4 [949.4, 969.4].

(11) Name, address, License number, and signature of the RPF who has been retained by the Timber Owner or operator to provide professional advice throughout the Timber Operations pursuant to 14 CCR § 1052(f).

(b) Timber Operations pursuant to an emergency notice shall comply with the Rules and regulations of the Board. A person conducting Timber Operations under an Emergency Notice shall comply with all operational provisions of the Forest Practice Act and District Forest Practice Rules applicable to "Timber Harvest Plan", "THP", and "Plan".

(c) In-lieu practices for Watercourse and lake protection zones as specified under Article 6 of the Rules, exceptions to Rules, and alternative practices are not allowed unless necessary to protect public health and safety.

(d) Timber Operations pursuant to an Emergency Notice may not commence for five working days or 15 days for a fuel hazard emergency per 14 CCR §§ 1052.1(e) and 1052.4, from the date of the Director's receipt of the Emergency Notice unless such waiting period is waived by the Director. The Director shall determine whether the emergency notice is complete. If it is found to be complete the Director shall send a copy of a notice of acceptance to the Timberland Owner. If the Emergency Notice is not complete it shall be returned to the submitter. If the Director does not act within five working days, 15 days for a fuel hazard emergency per 14 CCR §§ 1052.1(a)(5) and 1052.4, of receipt of the Emergency Notice, Timber Operations may commence.

(e) Timber Operations shall not continue beyond one (1) year from the date the Emergency Notice is accepted by the Director unless a plan is submitted to the Director and found to be in conformance with the

CALIFORNIA FOREST PRACTICE RULES

Rules and regulations of the Board, except for treatment of fuels in accordance with 14 CCR § 1052.4(d)(4) and (5).

(f) An RPF shall be retained by the Timber Owner or LTO to provide professional advice throughout the Timber Operations and shall be present, or ensure that the RPF's Supervised Designee is present, on the Logging Area at a sufficient frequency to know the progress of operations and advise the LTO and Timberland Owner, but not less than once during the life of the notice.

1052.1 Emergency Conditions

(a) The following are conditions that constitute an emergency pursuant to 14 CCR 895.1:

(1) Trees that are dead or dying as a result of insects, disease, parasites, or animal damage.

(2) Trees that are fallen, damaged, dead or dying as a result of wind, snow, freezing weather, drought, fire, flood, landslide or earthquake.

(3) Trees that are dead or dying as a result of air or water pollution.

(4) Cutting or removing trees required for emergency construction or repair of roads.

(5) Where high, very high or extreme fuel hazard conditions, the combination of combustible fuel quantity, type, condition, configuration and terrain positioning, pose a significant fire threat on private Timberlands. Cutting and removal of hazardous fuels, including trees, shrubs and other woody material, is needed to eliminate the vertical and horizontal continuity of understory fuels, and surface fuels, and/or crown fuels, for the purpose of reducing the rate of fire spread, fire duration and intensity, and fuel ignitability.

(6) An isolated infestation of Sudden Oak Death (caused by *Phytophthora ramorum*), in the locations listed below, where such treatments are intended to eradicate the infestation or significantly slow the spread of the disease. For the purpose of this rule an isolated infestation is:

(A) An infestation located in a planning watershed where SOD had not previously been noted; or

(B) An infestation located in a planning watershed that is greater than 1 mile from a known SOD infestation; or

(C) A new infestation within a planning watershed where all known previous SOD infestations within the ownership have been or will be subject to control or eradication efforts; or

(D) A location where landowners seek to contain an infestation, even though some landowners have not made proactive efforts within a planning watershed, and the Department's Pest Specialist determines that control efforts may be effective.

(E) An isolated infestation is limited to locations in the following counties: Alameda, Contra Costa, Del Norte, Humboldt, Lake, Marin, Mendocino, Monterey, Napa, San Mateo, San Luis Obispo, Santa Clara, Santa Cruz, Solano, and Sonoma.

(b) The following are conditions that constitute a financial Emergency as defined in 14 CCR § 895.1:

(1) Potential financial loss of timber previously inoperable or unmerchantable due to one or more of the following factors: access, location, condition, or timber volume that has unexpectedly become Feasible to harvest provided that the harvest opportunity will not be economically Feasible for more than 1 year and provided that such operations meet the conditions specified in 14 CCR §§ 1038.1(c)(5)-(14) and 1038.3(p) and meet minimum Stocking requirements at the completion of Timber Operations.

1052.2 Emergency Substantiated by RPF

The RPF preparing the Notice of Emergency Timber Operations shall describe the nature of the emergency and the need for immediate cutting in sufficient detail so that the reason for the emergency is clear. An emergency is presumed to exist where:

(a) Trees or vegetation have been confirmed to be infected with the pathogen that causes Sudden Oak Death through testing by a lab certified by the United States Department of Agriculture, and the RPF has determined that the pathogen is likely to spread to adjacent trees or vegetation, or

(b) Tree killing insects have killed and are likely to kill trees within one year on Timberland. Trees will be considered likely to die when they are determined, by an RPF, to be high risk by either:

(1) Risk classification systems including Smith et al., 1981; The California pine risk-rating system: its development, use, and relationship to other systems; In Hazard-Rating Systems in Forest Insect Pest Management, Hedden et al., eds. USDA Forest Service General Technical Report WO - 27, pp. 53-69;

CALIFORNIA FOREST PRACTICE RULES

Ferrell. 1989; Ten-year risk-rating systems for California Red Fir and White Fir: development and use; USDA Forest Service General Technical Report PSW-115, 12p.; or similar risk-rating systems recognized by the profession; or

(2) Where evidence of a current beetle attack exists (i.e. existence of boring dust, woodpecker feeding, or recent top kill) and these trees are within 100 feet of multiple tree kills. Such trees shall be marked by an RPF or the supervised designee before felling.

1052.3 Emergency Notice For Insect Damaged Timberlands

Emergency Timber Operations, under the presumed emergency standard of 14 CCR 1052.2, may be commenced provided an RPF is responsible for an on-site inspection, and tree marking when required by subsection (a):

(a) The emergency notice used with this section is to be used only for the harvesting of dead trees and those dying because of insect attack. Trees with green crowns that are to be harvested must be under insect attack which is likely to lead to mortality within one year, and shall be stump marked or otherwise designated by an RPF prior to cutting.

1052.4 Emergency Notice for Fuel Hazard Reduction

The RPF preparing the Notice of Emergency Timber Operations for Fuel Hazard Reduction shall describe the nature of the emergency and the need for immediate cutting in sufficient detail so that the reason for the emergency is clear. Emergency Timber Operations, under the presumed emergency standard of 14 CCR § 1052.1, may be commenced and conducted when in conformance with the following:

(a) RPF develops and documents the vegetative treatments necessary to meet the goals of 14 CCR § 1052.1(a)(5), and ensures post-harvest conditions are in accordance with all subsections in 14 CCR § 1052.4. Such documentation shall include the following:

(1) A description of the preharvest stand structure and statement of the postharvest stand stocking levels, and description of postharvest stand structure.

(2) A description of the criteria to designate trees to be harvested or trees to be retained, including those trees harvested pursuant to 14 CCR § 1052.4(d)(1)(A) and (d) (2).

(3) All trees that are harvested or all trees that are retained shall be marked or sample marked by, or under the supervision of, an Registered Professional Forester before felling operations begin. When trees are sample marked, the designation prescription for unmarked areas shall be in writing and the sample mark area shall include at least 10% of the harvest area to a maximum of twenty (20) acres per stand type which is representative of the range of conditions present in the Harvest Area.

(b) The conditions of 14 CCR § 1038.1(c)(5)-(14), and 1038.3(p) are applied and, for operations in the Lake Tahoe Region, 1038.1(b) is applied.

(c) Geographic area: operations are permitted:

(1) Within one-quarter ($\frac{1}{4}$) mile from approved and legally permitted structures that comply with the Building Standards Code (legal structure). Such legal structures shall be within or adjacent to a community listed in the "List of Communities at Risk" (As published April 13, 2019 and hereby incorporated by reference) and have densities greater than one (1) structure per twenty (20) acres.

(2) Within five hundred (500) feet:

(A) A legal structure outside the area defined in 14 CCR § 1052.4(c)(1); or

(B) Either side of a federal or Public Road; or

(C) Either side of a private road providing access to legal structures; or

(D) Either side of haul roads suitable for evacuation or fire suppression with the written concurrence of a Public Fire Agency and determined by the Director to be consistent with the purpose of the Act and Rules; or

(E) Either side of ridges suitable for fire suppression with the written concurrence of a Public Fire Agency and determined by the Director to be consistent with the purpose of the Act and Rules; or

(F) Infrastructure including electrical distribution and transmission facilities, water reservoirs or other conveyances, wastewater facilities or conveyances, communication and data transmission and distribution facilities, or other assets or infrastructure at risk with the written concurrence of a Public Fire Agency and determined by the Director to be consistent with the purpose of the Act and Rules.

CALIFORNIA FOREST PRACTICE RULES

(d) Vegetation Treatments: Tree removal shall target Codominant and understory trees. The residual stand shall consist primarily of well-distributed, healthy and vigorous dominant and codominant trees from the preharvest stand.

(1) The following restrictions exist related to the diameter of trees that may be harvested pursuant to this section:

(A) Only trees less than thirty (30) inches in stump Diameter, measured at eight (8) inches above ground level, may be removed except under the following condition: if the goal of fuel reduction cannot be achieved by removing trees less than thirty (30) inches in stump Diameter, measured at eight (8) inches above ground level, trees less than thirty-six (36) inches in stump Diameter, measured at eight (8) inches above ground level, may be removed if that removal is necessary to meet the fuel objectives stated in 14 CCR § 1052.1(a)(5).

(B) No trees of the genus *Quercus* that are greater than twenty-six (26) inches outside bark stump diameter, measured at eight (8) inches above ground level, may be removed.

(2) Notwithstanding 14 CCR § 1052.4(d)(1)(A) and (B), dead or Dying trees, of any size, may be removed according to the standards of 14 CCR § 919.1 [939.1, 959.1], as applicable.

(3) **(A)** The following canopy retention requirements are applicable to Timber Operations conducted pursuant to 14 CCR §§ 1038(f) and 1038.3: Minimum post treatment canopy closure of dominant and codominant trees shall be 40% for east side pine forest types; 50% for coastal redwood and Douglas–fir forest types in or adjacent to communities and legal structures referenced in 1052.4(c)(1) and (c)(2)(A); 60% for coastal redwood and Douglas–fir forest types outside of communities and legal structures referenced in 1052.4(c)(1) and (c)(2)(A); and 50% percent for mixed conifer and all other forest types.

(B) The following canopy retention requirements are applicable to emergency Timber Operations conducted pursuant to 14 CCR §1052.4:

1. Except for the conditions described within 2. below, minimum post treatment Canopy closure of Dominant and Codominant trees shall be 30% for east side pine forest types; 40% for coastal redwood and Douglas-fir forest; and 40% for mixed conifer and all other forest types.

2. When the average diameter of residual trees within the Harvest Area is less than sixteen (16) inches d.b.h. and the pre-treatment stand conditions described within 14 CCR § 1052.4(a)(1) are representative of homogenous forest stand conditions typical of plantations (such as homogeneity in: age distribution, d.b.h., height, or species composition), either of the retention standards set forth in a. or b. below must be achieved.

a. Minimum post treatment Canopy closure of Dominant and Codominant trees shall be 30% for east side pine forest types; 40% for coastal redwood and Douglas-fir forest; and 40% for mixed conifer and all other forest types.

b. A minimum of sixty-five (65) trees per acre over four (4) inches d.b.h. shall be retained.

(4) **(A)** Within the Harvest Area, Surface Fuels, Ladder Fuels, Slash, Woody Debris, and dead brush that will promote the spread of wildfire shall be treated as follows:

1. Those fuels described within (A) above, excluding residual stand Dominant and Codominant trees and any dead branches on those trees, shall be spaced to achieve vertical clearance distance of eight (8) feet or three (3) times the height of the post-harvest fuels and vegetation, excluding Dominant and Codominant trees, whichever is the greater distance, measured from the base of the live crown of the post-harvest Dominant and Codominant trees to the top of the surface or Ladder Fuels or vegetation, whichever is taller.

2. Additional fuel treatment standards are as follows:

a. Within one hundred-fifty (150) feet of those structures identified within 14 CCR § 1052.4(c)(1) and (c)(2)(A), all Surface Fuels, Slash, Woody Debris, and dead brush that will promote the spread of wildfire shall be chipped, burned, or removed within forty-five (45) days from the start of Timber Operations.

b. Except for those areas described in provision a. above, all Surface Fuels, Slash, Woody Debris, and dead brush that will promote the spread of wildfire, within the Harvest Area, shall be treated to an average depth of less than nine (9) inches.

(B) Postharvest compliance shall be determined by the combination of physical

CALIFORNIA FOREST PRACTICE RULES

measurements and observations. Postharvest compliance shall be met on at least 80% of the Project area as calculated excluding WLPZs and other wildlife protection requirements developed in accordance with 14 CCR § 1052.4(g).

(C) The requirements of this subsection shall not supersede requirements of PRC § 4291.

(5) Fuel treatments shall include chipping, removal or other methods necessary to achieve the fuel hazard reduction standards in this section, and, notwithstanding the requirements of 14 CCR § 1052.4(d)(4)(A)2.a., shall be accomplished within one (1) year from the date the Emergency Notice is accepted by the Director, except for burning operations, which instead shall be completed within two (2) years from the date the Director accepts the notice.

(e) Stocking shall meet the resource conservation standards for minimum Stocking within 14 CCR § 912.7 [932.7, 952.7] (a)-(c), as applicable, immediately upon completion of Timber Operations. Because the lands treated pursuant to 14 CCR § 1052.4 are designated as defensible space or Fuelbreak areas, the wood production potential of these lands is compatible with the lowest Site Classifications and they shall be considered site IV Timberland for Stocking purposes.

(f) The resource conservation standards of the Rules may be met with Group A and/or Group B commercial species. The percentage of the stocking requirement met with Group A species shall be no less than the percentage of the stand basal area they comprised before harvesting. The following information shall be supplied by the RPF preparing the Notice and included in submission of the Notice:

(1) How using Group B species to meet the resource conservation standards will meet the intent of 14 CCR § 1052.4. The discussion shall include at least:

(A) The management objectives of the post-harvest stand.

(B) A description of the current stand, including species composition and current stocking levels within the area of Group B species. The percentage may be measured using point-count, basal area, or stocked plots.

(C) The percentage of the post-harvest stocking to be met with Group B species. Post-harvest percentages will be determined on the basis of stocked plots. Only the methods provided for in 14 CCR §§ 1070-1075 shall be used in determining if the standards of PRC § 4561 have been met.

(D) A description of what will constitute a countable tree, as defined by PRC § 4528 for Group B species, and how such a tree will meet the management objectives of the post-harvest stand.

(g) As part of the preharvest Project design, the RPF shall incorporate habitat requirements for fish, wildlife and plant Species in accordance with 14 CCR §§ 898.2, 916.9 [936.9, 956.9] and 919 [939, 959] *et seq.* Such evaluations shall include use of the California Natural Diversity Database (as referenced by the CDFW, <https://www.wildlife.ca.gov/Data/CNDDDB>) and local knowledge of the Planning Watershed. Consultation with CDFW personnel is recommended. Examples of habitat requirements to be incorporated into the Project include retention of large Woody Debris and Snags congruent with Emergency condition goals, and vegetative screening for wildlife cover and visual aesthetics.

(h) Before commencement of Timber Operations by each LTO directly responsible for Timber Operations identified on the Notice, the RPF who prepared the Notice, or their Supervised Designee, shall meet with either the LTO or the LTO's representative. The purpose of the meeting shall be for the RPF to familiarize the LTO with the Notice, the Harvest Area described within the Notice, and specific applicable requirements of the Notice. The meeting shall be on-site if requested by either the RPF or LTO. An on-site meeting is required between the RPF or Supervised Designee familiar with on-site conditions and the LTO to discuss protection of any archaeological or historical sites requiring protection, if any such sites exist within the site survey area, pursuant to 14 CCR § 929.2 [949.2, 969.2] (b).

1052.5. Emergency Notice for Outbreaks of Sudden Oak Death Disease.

(a) The RPF preparing the Emergency Notice shall do all of the following:

(1) provide as part of the Emergency Notice the certified lab testing results validating that trees or vegetation in the infestation area are infected with *Phytophthora ramorum*, the pathogen responsible for SOD;

(2) seek to encompass the entire infestation area and landownership(s) necessary to undertake effective control or eradication in the area covered by the Emergency Notice, however, the Emergency Notice is not required to encompass these areas;

CALIFORNIA FOREST PRACTICE RULES

(3) obtain written concurrence from a Department Forest Pest Specialist or Department designee regarding tree and vegetation treatments or removal and strategies to control or suppress the SOD infestation pursuant to 14 CCR § 1052.5(c);

(4) designate for treatment or removal the host hardwood species in the infested areas and within 330 feet of the infestation area to control the spread of SOD consistent with Forest Pest Specialist concurrence in (3) above;

(5) avoid designation of conifer trees for treatment or removal except as necessary to facilitate the removal of host hardwood species, the salvage of conifer trees accidentally damaged during Timber Operations, or as specified by a Department Forest Pest Specialist for purposes of controlling the spread of SOD.

(b) Timber Operations conducted in accordance with 14 CCR § 1052.5 (a) above shall comply with all Rules and regulations of the Board. A person conducting Timber Operations under an Emergency Notice for Outbreaks of Sudden Oak Death Disease shall comply with all operational provisions of the Forest Practice Act applicable to a plan as defined in 14 CCR § 895.1 with the following exceptions or additional requirements:

(1) The RPF shall provide written proof of notification regarding the proposed submission of an Emergency Notice for SOD eradication to the NMFS, CDFW, USFWS, and the applicable RWQCB. Written notification shall be received by NMFS, CDFW, USFWS, and the applicable RWQCB at least 10 working days prior to submission of the Emergency Notice.

(2) Tree and vegetation removal or treatment within WLPZ areas shall be permitted and limited to symptomatic hardwood trees and shrubs that are infested with SOD or host hardwood trees that will continue to contribute to the spread of SOD. Conifer trees shall not be removed in WLPZs.

(3) WLPZ harvesting restriction for Class I and II Watercourse pursuant to 14 CCR § 916.3 [936.3, 956.3], subsection (f) do not apply.

(4) Timing and methods of operations shall avoid Impacts to state and federally listed species. Below are required practices to avoid or minimize adverse effects to state and federally listed species to comply with the Endangered Species Act of 1973, as amended (16 U.S.C. 1531 *et seq.*). The practices are designed to reduce adverse Impacts to listed species, but do not guarantee that activities will not result in “take.”

(A) The RPF preparing the Emergency Notice shall evaluate and incorporate habitat requirements for fish, wildlife, and plant species using the California Natural Diversity Database maintained by the CDFW, local knowledge of the planning watershed, and consultation with the Department regarding other plans in the Emergency Notice area.

(B) RPFs shall contact the appropriate United States Fish and Wildlife Service field offices websites to obtain preliminary species lists and determine which species may be in the area and possibly affected by Timber Operations.

(C) The following general practices for protection of species shall be implemented in all areas:

(i) The exact location of harvesting sites and methods shall be adjusted to minimize the temporary or permanent Impacts to critical habitat for any federally-listed species. Access roads, staging areas, and Landings shall be located to avoid species habitats and designated critical habitat.

(ii) Clearly visible flagging or temporary fencing shall be placed around habitat or around designated Logging Roads, Landings, and staging areas to ensure vehicles and equipment remain within well-defined project boundaries.

(iii) Timber Operations shall avoid Impacting streambeds and banks in Channel Zones or other portions of the WLPZ for all Watercourses to the extent feasible, consistent with 14 CCR §§ 916.3(c), 916.4(d) and 916.9(e). The restrictions for Timber Operations in Channel Zones pursuant to 14 CCR § 916.9(e) are herein modified to permit timber falling, removal consistent with this subsection, or other treatments of trees and other vegetation symptomatic of the pathogen that causes Sudden Oak Death or host hardwood trees that could spread the pathogen.

(iv) All trash that may attract predators of federally-listed species shall be removed from work sites or completely secured at the end of each work day.

(v) If a federally-listed animal species is observed within a designated work area and cannot be avoided, all work shall stop until the animal leaves the work area.

CALIFORNIA FOREST PRACTICE RULES

(vi) No Timber Operations shall be conducted on saturated soil conditions.

(vii) No tree felling operations from July 15 to September 30 that reduce overstory canopy cover in WLPZs.

(viii) No Mechanical Site Preparation, Broadcast Burning, or pile burning in all WLPZs.

(ix) Operations shall be conducted in accordance with conditions stated in 14 CCR § 1038 (b)(1),(2),(3),(4),(5),(6),(7), (8), and (10).

(5) Where present prior to the start of Timber Operations, post-harvest stocking standards specified in 14 CCR § 912.7 [932.7, 952.7], subsection (b)(2) shall be met with group A species. Where stocking of Group A species is not sufficient to meet the stocking standards of 14 CCR § 912.7 [932.7, 952.7], subsection (b)(2), post treatment stocking shall meet those stated in 14 CCR § 913.4 [933.4, 953.4], subsection (b), Rehabilitation of Understocked Area Prescription. The percentage of stocking requirements met with Group A species on a point count basis shall be no less than the percentage of the basal area they comprised before harvesting.

(6) The Department shall track the number of Emergency Notices for outbreaks of SOD, the acreage treated under the notices, and the WLPZ acreage treated under the notices, and report the results to the Board bi-annually.

(c) The RPF shall describe the strategies employed which will be utilized to control or suppress the SOD infestation on the harvest area along with those measures to be used to minimize the risk of spreading *Phytophthora ramorum* from the logging area by way of infected soil and infected host material. In developing such strategies, the RPF shall draw from the list of Mitigation and Management Recommendations in the California Oak Mortality Task Force publication *Sudden Oak Death Guidelines for Forestry* (rev. August 2010), <https://bof.fire.ca.gov/media/cg2dgsyy/ada-august-2010-sudden-oak-death-guidelines-for-forestry.pdf>, herein incorporated by reference.

Article 3 Timber Harvesting Plan Appeal Procedures

1053 Purpose of Regulations

The regulations contained in this article govern procedures affecting appeals to the Board on return of plans by the Director pursuant to the provisions of PRC 4582.7.

1054 Return of Plan by Director

(a) When the Director determines that a plan is not in conformance with the Rules of the Board, the plan shall be returned to the person submitting the plan with a statement including the following:

(1) The reasons for returning the plan;

(2) Notice that the person submitting the plan has a right to a public hearing before the Board, providing the person submitting the plan requests such hearing within 10 days from receipt of such plan as set forth in 14 CCR [1054.1]; and

(3) Notice that Timber Operations under the plan shall not commence.

(b) The plan and said statement shall be delivered as follows:

(1) By personal service upon the person submitting the plan; or

(2) By registered or certified mail, return receipt requested, to the person submitting the plan at last address of record.

1054.1 Right to Request Public Hearing

Any person submitting a plan to whom such plan is returned by the Director on the grounds that it is not in conformance with the Rules of the Board, may within ten days of receipt of the plan request a public hearing before the Board consistent with Sections [1054.2 and 1054.3].

1054.2 Form of Request for Hearing

The request for hearing shall be in writing and shall contain the following:

(a) A statement requesting a hearing before the Board;

(b) Identification of the plan; and

CALIFORNIA FOREST PRACTICE RULES

- (c) The name and address of the person making the request.

1054.3 Filing of Request for Hearing

Such request shall be deemed to be filed on the date, whichever is earlier, upon which it is postmarked or the date upon which it is otherwise received at the State Board of Forestry and Fire Protection at the State of California Resources Building, 715 P Street, Sacramento, CA 95814 or, P.O. Box 944246, Sacramento, CA 94244-2460.

1054.4 Public Hearing

The Board shall schedule and hold a public hearing on such request no later than 30 days from the filing of the request for hearing, or at such later time as may be mutually agreed upon by the Board and the person submitting the plan and filing the request. The hearing may be scheduled as part of a regular meeting of the Board, or as part of any special meeting, provided that sufficient time is provided for the notice of hearing in accordance with 14 CCR 1056.2.

1054.5 Notice of Hearing

- (a) At least 15 days prior to said hearing, public notice thereof shall be given as follows:
- (1) Mailing such notice to the applicant, and mailing such notice to the Director for distribution as provided in subsections (2)-(5) below;
 - (2) Mailing such notice to any person who has submitted written comment on the plan or to any person requesting notice of the appeal or hearing;
 - (3) Posting such notice in a conspicuous location available to the public in the appropriate CAL FIRE Review Team Office;
 - (4) Posting of such notice at the place where public notices are customarily posted at the county courthouse of the county within which the proposed Timber Operations are to take place;
 - (5) Any other dissemination of the notice determined to be appropriate by the Director to provide full participation in the hearing by the interested public.
- (b) The notice of hearing shall include the following:
- (1) The name of the person submitting the plan;
 - (2) Identification of the plan, including the number of the plan, a brief description of the location of the Timber Operations referred to in the plan by reference to any commonly known landmarks in the area, and a brief description of the proposed Timber Operations;
 - (3) A statement that the plan has been returned to the person submitting the plan because the Director has determined that the plan is not in conformance with the Rules of the Board, and that the person submitting the plan has requested a public hearing before the Board pursuant to PRC 4582.7. In addition, a statement inviting the person submitting the plan and the public to make statements at the hearing regarding the plan; and
 - (4) The time, date, and location of the public hearing.

1054.6 Hearing Record

The record before the Board upon the public hearing shall be as follows:

- (a) The timber harvesting plan;
- (b) All reports, findings, communications, correspondence, and statements in the file of the Department relating to the plan.

1054.7 Hearing Procedures

- (a) The public hearing should normally proceed in the following manner:
 - (1) Identification of the record;
 - (2) Statements on behalf of person submitting the plan;
 - (3) Statements by member of the public;
 - (4) Motion to close public hearing.
- (b) Notwithstanding the above, the chairperson may, in the exercise of discretion, determine the order of the proceedings.

CALIFORNIA FOREST PRACTICE RULES

(c) The chairperson may impose reasonable time limits upon statements and presentations and may accept written statements in lieu of oral statements.

(d) The public hearing shall be recorded either electronically or by other convenient means.

1054.8 Order of the Board

Following the public hearing, the Board shall determine whether, upon the record before it, the plan is in conformance with the Rules and regulations of the Board and the provisions of the Act. If the Board determines that the plan is in conformance with the Rules and regulations of the Board and the provisions of the Act, it shall make its order approving the plan. If the Board determines that the plan is not in conformance with the regulations of the Board and the provisions of the Act, it shall make its order disapproving the plan. Approval of the plan by the Board constitutes authorization that Timber Operations may commence and be conducted in accordance with the plan as approved and in accordance with the Rules and regulations of the Board and the provisions of the Act. Timber Operations shall not take place where the Board disapproves the plan. Disapproval of a plan shall be without prejudice to the applicant submitting a plan at any later time complying with the Rules and regulations of the Board and the provisions of the Act. Where the Board approves the plan, notice thereof shall be filed with the Secretary of Resources, and within 10 working days such notice shall be transmitted to the agencies and persons referred to in 14 CCR 1037.3, and for posting at the places referred to in Section 1037.1. The order of approval shall include written response to significant environmental points raised during the evaluation process.

1055 County Appeals Procedures

The Board of Supervisors of a county for which Rules and regulations have been adopted pursuant to PRC § 4516.5 may appeal the Director's approval of a THP by doing the following:

(a) No later than ten days from the date of approval, the county shall file with the Executive Officer of the State Board of Forestry and Fire Protection at the State of California Resources Building, 715 P Street, Sacramento, CA 95814 or P.O. Box 944246, Sacramento, CA 94244-2460 and mail to the Plan submitter a statement containing:

(1) The name of the submitter of the Timber Harvesting Plan;

(2) The number of the Timber Harvesting Plan;

(3) The location of the proposed Timber Operations;

(4) A concise summary of all facts upon which the appeal is based;

(5) A copy of or reference to all documents which support the appellant's position;

(6) The name and phone number of the county staff member who will be the primary contact for purposes of the appeal;

(7) A copy of the authorization by the Board of Supervisors or its authorized designee for the appeal and containing the specific finding that the public health and safety, or the environment is threatened by the approval of the Timber Harvesting Plan and what form that threat takes;

(8) Certification that the county participated in the initial inspection of the plan area with the Director and participated in a multidisciplinary review of the plan.

(b) The county shall promptly telephone the Director and the plan submitter to inform them of the filing of the appeal.

1055.1 Hearing on County Appeal

The Board shall grant to a county that meets the requirements for filing an appeal an initial hearing to consider the county's request for an appeal at the next regularly scheduled Board meeting following the receipt of the request. The Board shall grant a hearing on an appeal by a county pursuant to PRC 4516.6 if the Board finds that the appeal raises substantial issues with respect to public health and safety or to the environment. If the Board finds that the appeal raises no substantial issues with respect to public health and safety or to the environment, the Board shall refuse to grant a hearing on an appeal. In making this determination, the Board shall consider the following:

(a) Whether the appeal raises environmental issues which can be addressed by the Board within the limits of the PRC and the Rules of the Board; and

(b) Whether the appeal raises public health and safety issues which involve threats to the lives, health, or

CALIFORNIA FOREST PRACTICE RULES

property of county residents.

1055.2 County Appeal Hearing Procedures-Scheduling

The Board shall schedule and hold a public hearing on an appeal by a county no later than 30 days from the filing of the written statement of appeal, or at such later time as may be mutually agreed upon by the Board, the county, and the plan submitter. The hearing may be scheduled as part of a regular meeting of the Board or may be conducted by a committee of the Board as provided in PRC § 4516.6(d). Sufficient time must be provided for the notice of hearing in accordance with 14 CCR § 1055.3.

1055.3 County Appeal Hearing Procedures-Notice

(a) At least 15 days prior to the hearing, the Board shall give public notice as follows:

(1) Mailing the notice to the county and the plan submitter and sending the notice to the Director for distribution as provided in subsection (2)-(5) below;

(2) Mailing the notice to any person who has submitted written comment on the plan and to any person who requests notice of the appeal or hearing;

(3) Posting of the notice in a conspicuous location available to the public in the appropriate CAL FIRE Review Team Office;

(4) Posting of the notice at the place where notices are customarily posted at the county courthouse of the county within which the proposed Timber Operations are to take place;

(5) Any other dissemination of the notice determined to be appropriate by the Director to provide full participation in the hearing by the interested public.

(b) The notice of hearing shall include the following:

(1) The name of the Person submitting the plan;

(2) Identification of the plan, including the number of the plan, a brief description of the location of the Timber Operations referred to in the plan by reference to any commonly known landmarks in the area, and a brief description of the proposed Timber Operations;

(3) A statement that the county has appealed the Director's decision to approve the plan and has requested a public hearing pursuant to PRC 4516.6. The notice shall also include a statement inviting the person submitting the plan and the public to make statements at the hearing regarding the plan; and

(4) The time, date, and location of the public hearing.

1055.4 County Appeal Hearing Procedures-Record

The record before the Board upon the public hearing shall be as follows:

(a) The timber harvesting plan;

(b) All reports, findings, communications, correspondence and statements in the file of the Department relating to the plan.

1055.5 County Appeal Hearing Procedures-Sequence

(a) The public hearing should normally proceed in the following manner:

(1) Identification of the record;

(2) Statements on behalf of the county;

(3) Statements on behalf of person submitting the plan;

(4) Statements of members of the public;

(5) Motion to close public hearing.

(b) Notwithstanding the above, the chairperson may in the exercise of discretion, determine the order of the proceedings.

(c) The chairperson may impose reasonable time limits upon statements and presentations and may accept written statements in lieu of oral statements.

(d) The public hearing shall be recorded either electronically or by other convenient means.

1055.6 County Appeal Hearing Procedure-Order

Following the public hearing, the Board shall determine whether, upon the record before it, the plan is in

CALIFORNIA FOREST PRACTICE RULES

conformance with the Rules and regulations of the Board and the provisions of the Act. If the Board determines that the plan is in conformance with the Rules and regulations of the Board and the provisions of the Act, it shall make its order approving the plan. If the Board determines that the plan is not in conformance with the regulations of the Board and the provisions of the Act, it shall make its order disapproving the plan. Approval of the plan by the Board constitutes authorization that Timber Operations may commence and be conducted in accordance with the plan as approved and in accordance with Rules and regulations of the Board and the provisions of the Act. Timber Operations shall not take place where the Board disapproves the plan. Disapproval of a plan shall be without prejudice to the applicant submitting a plan at any later time complying with the Rules and regulations of the Board and the provisions of the Act. Where the Board approves the plan, notice thereof shall be filed with the Secretary of Resources, and within ten working days such notice shall be transmitted to the agencies and persons referred to in 14 CCR 1037.3, and for posting at the places referred to in Section 1037.1. The order of approval shall include written response to significant points raised in the appeal.

1056 Head of Agency Appeals Procedure

The State Water Resources Control Board (SWRCB) or the Director of the CDFW pursuant to PRC § 4582.9 may appeal the Director's approval of a THP, or Substantial Deviation (14 CCR §§ 1036 and 1039) by doing the following:

(a) No later than ten days from the date of THP approval, the SWRCB and CDFW shall file with the Executive Officer of the State Board of Forestry and Fire Protection and mail to the plan submitter and Director of CAL FIRE a statement containing:

- (1) The name of the submitter of the THP;
- (2) The number of the THP assigned by CAL FIRE;
- (3) The location of the proposed Timber Operations as described in the Notice of Intent;
- (4) A concise summary of all facts upon which the appeal is based;
- (5) A copy of or reference to all documents within the official THP record which support the appellant's position;
- (6) The name and phone number of the SWRCB designee or CDFW staff member who will be the primary contact for purposes of the appeal;
- (7) A copy of the authorization by the SWRCB or CDFW or its authorized designee for the appeal and containing the specific finding that the environment or the public health, safety, or general welfare is threatened by the approval of the THP or Substantial Deviation and what form that threat takes;
- (8) Certification that the SWRCB or RWQCB or CDFW participated in a multidisciplinary review of the plan including an on-site inspection prior to plan approval;
- (9) A statement that the Timber Operations are not to proceed until the appeal has been acted on by the Board as stated in PRC § 4582.9.
- (10) A copy of regulations pertaining to head-of-agency appeals.
- (11) A statement to contact the Board for other information about the hearing process.

(b) The SWRCB or CDFW shall promptly telephone the Director and plan submitter to inform them of the filing of the appeal.

(c) If Timber Operations have commenced, the Department will notify the Timber Operator to stop all operations.

1056.1 Hearing on Head of Agency Appeal

The Chairman of the State Board of Forestry and Fire Protection (Board) shall, without being required to consult other members of the Board, within five (5) working days of receiving the appeal grant a hearing on an appeal by SWRCB or CDFW pursuant to PRC § 4582.9 if the Chairman finds that the appeal raises substantial issues with respect to the environment or to public safety. If the Chairman finds that the appeal raises no substantial issues with respect to the environment or to public safety, he or she shall refuse to grant a hearing on an appeal. The Chairman will inform the appealing agency, the plan submitter, and the Department of his or her decision. In making this determination, the Chairman shall consider the following:

(a) Whether the appeal raises environmental issues which can be addressed by the Board within the limits of the PRC and the Rules of the Board and other applicable laws; and

CALIFORNIA FOREST PRACTICE RULES

(b) Whether the appeal raises public safety issues which involve threats to the lives, health, or property of state residents.

1056.2 Head of Agency Appeal Hearing Procedures-Scheduling

The Board shall schedule and hold a public hearing on an appeal by SWRCB or CDFW no later than 30 days from the filing of the written statement of appeal, or at such later time as may be mutually agreed upon by the Board, the appellant(s), and the plan submitter. The hearing may be scheduled as part of a regular meeting of the Board or may be conducted by a committee of the Board as provided in PRC § 4582.9 (d). Sufficient time must be provided for the notice of hearing in accordance with 14 CCR § 1056.3.

1056.3 Head of Agency Appeal Procedures-Notice

(a) At least 15 days prior to the hearing, the Board shall give public notice as follows:

- (1) Mailing the notice to the SWRCB designee or CDFW, and the plan submitter and sending the notice to the Director for distribution as provided in subsection (2)-(5) below;
- (2) Mailing the notice to any person who has submitted written comment on the plan and to any person who requests notice of the appeal or hearing;
- (3) Posting of the notice in a conspicuous location available to the public in the appropriate CAL FIRE Review Team Office and Unit Headquarters;
- (4) Posting of the notice at the place where notices are customarily posted at the county courthouse of the county within which the proposed Timber Operations are to take place;
- (5) Any other dissemination of the notice determined to be appropriate by the Director to provide participation in the hearing by the interested public.

(b) The notice of hearing shall include the following:

- (1) The name of the person submitting the plan;
- (2) Identification of the plan, including the CAL FIRE administration number of the plan, a brief description of the location of the Timber Operations referred to in the plan by reference to any commonly known landmarks in the area, and a brief description of the proposed Timber Operations;
- (3) A statement that the SWRCB or CDFW has appealed the Director's decision to approve the plan. A statement that the Board has granted a public hearing pursuant to PRC § 4582.9. The notice shall also include a statement inviting the person submitting the plan and the public to make statements at the hearing regarding the basis of the appeal on the plan; and
- (4) The time, date, and location of the public hearing.

1056.4 Head of Agency Appeal Hearing Procedures-Record

The record before the Board upon completion of the public hearing shall be as follows:

- (a) The THP, or Substantial Deviation.
- (b) All reports, findings, communications, correspondence and statements in the file of the Department relating to the plan at the time of approval.
- (c) Arguments from the appealing agency, plan submitter, and the public related to the material in the record.

1056.5 Head of Agency Appeal Hearing Procedures-Sequence

(a) The public hearing should normally proceed in the following manner:

- (1) Identification of the record by CAL FIRE;
 - (2) Statements on behalf of the appealing agency;
 - (3) Statements on behalf of person submitting the plan;
 - (4) Statements of members of the public, including other interested agencies;
 - (5) Response on behalf of CAL FIRE "Chairman or designee";
 - (6) Motion to close public hearing;
- (b) Notwithstanding the above, the chairman or designee may in the exercise of discretion, determine the order of the proceedings.
- (c) The chairperson may impose reasonable time limits upon statements and presentations and may accept written statements in lieu of oral statements.

CALIFORNIA FOREST PRACTICE RULES

- (d) The public hearing shall be recorded either electronically or by other convenient means.

1056.6 Head of Agency Appeal Hearing Procedures-Order

The Board has ten days following the public hearing to determine whether, upon the record before it, the plan is in conformance with the Rules and regulations of the Board, the provisions of the Act and all other applicable provisions of law, including the Timberland Productivity Act. If the Board determines that the plan is in conformance with the Rules and regulations of the Board, the provisions of the Act and other applicable laws, it shall make its order approving the plan within ten days of conclusion of the hearing. If the Board determines that the plan is not in conformance with the regulations of the Board, the provisions of the Act, and other applicable laws, it shall make its order disapproving the plan within 10 days of conclusion of the hearing. Approval of the plan by the Board constitutes authorization that Timber Operations may commence upon filing of the order of approval with the Secretary of Resources. Operations shall be conducted in accordance with the plan as approved by CAL FIRE and in accordance with the Rules and regulations of the Board and the provisions of the Act, and other applicable laws. Timber Operations shall not take place where the Board disapproves the plan. Disapproval of a plan shall be without prejudice to the applicant submitting a plan at any later time complying with the Rules and regulations of the Board and the provisions of the Act. The Board may set forth in the order of disapproval the conditions under which it believes the plan would have been approved. Where the Board approves the plan, the order there of shall be filed with the Secretary of Resources within ten working days of decision, such order of approval shall be transmitted to the plan submitter, CAL FIRE, and the appealing agency(ies), and for posting at the places referred to in Section 1056.3. Their order of approval shall include written response to significant points raised in the appeal.

Article 3.2 Administrative Penalty Hearing Procedures

1057 Purpose of Regulations

The regulations contained in this article govern procedures for request(s) for hearing(s) to the Board of Forestry and Fire Protection pursuant to Public Resources Code (PRC) §4601.2 concerning issuance of an administrative penalty by the Director of the Department of Forestry and Fire Protection.

1057.1 Filing of Petition and Notice of Defense/Request for Hearing

Any person filing a petition to the Board pursuant to PRC §4601.2 concerning the issuance of an administrative penalty by the Director shall, within ten (10) days of service of the complaint and proposed order setting an administrative penalty, file a Notice of Defense/Request for Hearing with the Board requesting a hearing. The Notice of Defense/Request for Hearing shall be on the form set forth in Section 1057.5 of this article and shall supply the following information to the Board:

- (a) Written statements, with supporting documentation, indicating specifically the basis for the petitioner's challenge of the Director's complaint and proposed order of administrative penalty;
- (b) A written statement advising the Board of the name, address and telephone number of the petitioner's representative, if any.

1057.2 Failure to Request Hearing

If the petitioner fails to file a Notice of Defense/Request for Hearing within the time period referenced in Section 1057.1 of this article, the Board shall adopt the Director's Complaint and Proposed Order without hearing.

1057.3 Hearing Procedures

A hearing shall be conducted within 180 days of the date on which the petitioner was served with the complaint and proposed order provided a timely request for a hearing has been received. The Chairperson of the Board may delegate the conduct of the hearing to a committee of the Board, which shall be composed of at least three (3) members of the Board, or elect to utilize an Administrative Law Judge assigned in accordance with Government Code §11370.3. If the Chairperson delegates the matter to a committee of the

CALIFORNIA FOREST PRACTICE RULES

Board, a majority of the committee members shall not have a financial interest in the forest products or range industry. The committee may exercise any power the Board may exercise in any action under this article.

If the matter is heard before the full Board or a committee of the Board, the Chairperson may elect to use an Administrative Law Judge or a representative from the Office of the Attorney General to preside over the hearing.

If the matter is to be assigned to an Administrative Law Judge, the Chairperson shall indicate if the Administrative Law Judge is to provide a Proposed Decision for review by the Board, or, in the alternative, if the Decision of the Administrative Law Judge is final. In the event that the matter is delegated to an Administrative Law Judge, the proceedings shall be conducted in accordance with the provisions of Chapter 5 (commencing with §11500) of Part 1, Division 3, Title 2 of the Government Code.

1057.4 Administrative Record

The Administrative Record shall consist of the following:

(a) the record developed and evidence submitted during the hearing before an Administrative Law Judge, including but not limited to the Proposed Decision and Findings of Fact, when the hearing was conducted before an Administrative Law Judge; or,

(b) the Complaint and Proposed Order from the Director, evidence submitted by the Director, evidence submitted on behalf of the petitioner, any other relevant evidence which, in the judgment of the Board, should be considered applicable, and testimony presented during the hearing on the petition if the hearing is conducted before the Board.

CALIFORNIA FOREST PRACTICE RULES

1057.5 Petition and Notice of Defense/Request for Hearing Form

BEFORE THE
BOARD OF FORESTRY AND FIRE PROTECTION
FOR THE STATE OF CALIFORNIA

In the Matter of:

RESPONDENT.

CAL FIRE Docket No.:

**NOTICE OF DEFENSE;
REQUEST FOR HEARING**

I, the undersigned and respondent named in this proceeding, hereby acknowledge receipt of a copy of the Complaint and Proposed Order against me.

I hereby request a hearing in this proceeding to permit me to present my defense to the allegations contained in the Statement of Issues.

Dated: _____

Signed _____

(or attorney for respondent)

CALIFORNIA FOREST PRACTICE RULES

1058 Hearing Procedures-Notice

If the Board or committee of the Board holds a hearing on the matter, the following shall apply:

- (a) At least twenty (20) days prior to the hearing, the Board shall give public notice as follows:
 - (1) Mailing or delivering by personal service the notice to the petitioner;
 - (2) Mailing or delivering by personal service the notice to the Director;
 - (3) Mailing the notice to any person who requests notice of the petition or hearing; and
 - (4) Mailing the notice to the Board's regular mailing list.
- (b) The Notice of the hearing shall include:
 - (1) The name of the petitioner;
 - (2) A statement describing the basis for the action;
 - (3) The amount of the administrative penalty petitioned; and
 - (4) The date, time, and location of the hearing.

1058.1 Hearing Procedures-Recording and Transcription

Hearings conducted under the procedures of this article shall be electronically recorded by the Board. Cost of transcription or reproduction of the electronic recording, if requested shall be borne by the party making such request.

1058.2 Hearing Procedures-Use of Board Hearing Procedure and Sequence

(a) The Board shall conduct the petition hearing under this article in accordance with the provisions of Chapter 5 (commencing with §11500) of Part 1, Division 3, Title 2 of the Government Code. The hearing procedure is intended to satisfy due process and public policy requirements in a manner that is simpler and more expeditious than hearing procedures otherwise required by statute.

(b) The hearing shall normally proceed in the following manner:

- (1) Identification of any written material submitted to the Board prior to the hearing;
- (2) Statements on behalf of the petitioner and submission of evidence;
- (3) Cross Examination of petitioner's statements;
- (4) Statements on behalf of the Director and submission of evidence;
- (5) Cross Examination of Director's statements;
- (6) Rebuttal on behalf of the petitioner;
- (7) Rebuttal on behalf of the Director;
- (8) Closing statements on behalf of petitioner and Director;
- (9) Motion to close the hearing.

(c) Notwithstanding the above, the Chairperson or the Chairperson's designee (Board member) for the purposes of conducting the hearing may, in the exercise of discretion, determine the order of the proceedings.

(d) The Chairperson or the Chairperson's designee (Board member) shall have the authority to impose reasonable and equitable time limits upon statements and presentations and to accept written statements in lieu of oral statements. Any written statements shall be submitted to the Board at least ten days prior to the hearing.

1058.3 Hearing Procedures-Determination

(a) Following the hearing, the Board shall determine:

- (1) Whether the alleged violations cited in the Director's Proposed Order are supported by substantial evidence in light of the whole record (as defined in section 1057.4) before it; and
- (2) Whether to affirm, modify, or set aside, in whole or in part, the administrative penalty issued by the Director.

(b) The Board shall issue its own written order upholding its determination within forty-five (45) days of the close of the hearing.

(c) Notification of the Board's determination shall be made by certified mail or personal service to the petitioner and the Director within fifteen (15) days following the regular business meeting of the Board at which the decision is made.

CALIFORNIA FOREST PRACTICE RULES

1058.4 Review of Proposed Decision and Findings of Fact

If the Board Chairperson has assigned the hearing to an Administrative Law Judge and requested a Proposed Decision and Findings of Fact, the Board shall set on their agenda a review and discussion of the Proposed Decision and Findings of Fact at its next regularly scheduled meeting, where a quorum is present, following the receipt of the Proposed Decision and Findings of Fact from the Office of Administrative Hearings. Public notice of the agenda item shall be provided to those persons listed in section 1058 not less than ten (10) days prior to the Board meeting.

1058.5 Determination

The adoption, rejection or modification of the Proposed Decision, including the various procedural requirements and notifications, shall follow the process set forth in Chapter 5 (commencing with section 11500) of Part 1, Division 3, Title 2 of the Government Code, except that the Board shall make a written determination within forty-five (45) days of the date the Board first considered the proposed decision unless hearing transcripts are requested. If the Board orders transcripts of the proceedings before the Administrative Law Judge, the Board shall make a written determination within sixty (60) days of the receipt of those transcripts.

1059 Infractions

(a) Pursuant to PRC 4601.4(b), these Rules are procedural in nature, the violation of which does not result in or cause environmental damage. The rule list consists of 14 CCR Sections 915.4, 935.4, 955.4; 918.1, 938.1, 958.1; 924.1; 925.2; 925.4; 926.2; 926.3; 926.23; 927.2; 927.14; 928.2; 929.1, 949.1, 969.1; 1029; 1032.7; 1032.10; 1034; 1035.2; 1035.3(c); 1038.2; 1042; 1051.1; 1052(a); 1075; 1080.4; 1090.2; 1090.5; 1090.7; 1090.11; 1090.12(b); 1090.13; 1090.26; 1091.4; 1092.04(d); 1092.07; 1092.09; 1092.13; 1092.14(c); 1092.15; 1104.1(a)(1); 1105; 1106.1; 1106.3(a).

(b) Infractions shall not be prosecuted if they are corrected within 10 working days of issuance of notification of the violation. Notification and response must be by certified mail. Date of certification identifies date of notification and response.

CALIFORNIA FOREST PRACTICE RULES

Article 4 Timber Site Classification

1060 Site Classification

The site classification system of productive potential of Timberland for administration of the Act and Rules thereunder is set forth in the table hereinafter:

SITE CLASS	<i>Young Growth Redwood¹</i>		<i>Douglas Fir²</i>		<i>Ponderosa Pine, Jeffery Pine, Mixed Conifer & True Fir³</i>			
	SITE INDEX ⁴		SITE INDEX ⁴		SITE INDEX ⁴		SITE INDEX ⁵	
	<i>feet@ 100yrs.</i>	<i>meters@ 100yrs.</i>	<i>feet@ 100yrs.</i>	<i>meters@ 100yrs.</i>	<i>feet@ 100yrs.</i>	<i>meters@ 100yrs.</i>	<i>feet@ 300yrs.</i>	<i>meters@ 300yrs.</i>
I	<i>180 or more</i>	<i>54.86 or more</i>	<i>194 or more</i>	<i>59.12 or more</i>	<i>114 or more</i>	<i>35.11 or more</i>	<i>163 or more</i>	<i>49.68 or more</i>
II	<i>155-179</i>	<i>47.24-54.56</i>	<i>164-193</i>	<i>49.99-58.83</i>	<i>93-113</i>	<i>28.35-34.44</i>	<i>138-162</i>	<i>42.06-49.38</i>
III	<i>130-154</i>	<i>39.62-46.94</i>	<i>134-163</i>	<i>40.84-49.68</i>	<i>75-92</i>	<i>22.86-28.04</i>	<i>113-137</i>	<i>24.44-41.76</i>
IV	<i>105-129</i>	<i>32.00-39.32</i>	<i>103-133</i>	<i>31.39-40.54</i>	<i>60-74</i>	<i>18.29-22.56</i>	<i>88-112</i>	<i>26.82-34.14</i>
V	<i>Less than 105</i>	<i>Less than 32.00</i>	<i>Less than 103</i>	<i>Less than 31.39</i>	<i>Less than 60</i>	<i>Less than 18.29</i>	<i>Less than 88</i>	<i>Less than 26.82</i>

¹Lindquist, James L., and Marshall N. Palley. *Empirical Yield Tables for Young-Growth Redwood*, California Agriculture Experiment Station Bulletin. 796, 47pps. 1963 (Site index based on average height of dominant trees at breast height age of 100 years). Use in young growth redwood stands in which more than 20% of the stand by basal area is redwood and when sufficient dominant redwood trees are available to determine site index.

²McArdle, Richard E., and Walter H. Meyer. *The Yield of Douglas Fir in the Pacific Northwest*. USDA Technical Bulletin 201, 74 pps. Rev. 1961. Adjusted to average height of dominant trees after Forest Research Note No. 44, Pacific Northwest Forest and Range Experiment Station, by Forest Survey, Calif. Forest and Range Experiment Station. 1948 (Site index based on average height of dominant trees at age 100 years). Use in young growth redwood stands in which 20% or less of the stand by basal area is redwood or when sufficient dominant redwood trees are not available to determine site index. Use also in old growth redwood stands. In such cases, measure Douglas-fir trees for determining site index. Also use for Sitka spruce, grand fir, hemlock, bishop pine, and Monterey pine stands.

³Dunning, Duncan. *A Site Classification for the Mixed-Conifer Selection Forests of the Sierra Nevada*. USDA Forest Service California Forest and Range Experiment Station, Forest Research Note 28, 21 pps. 1942 (Site index based on average height of dominant trees at age 100 and 300 years). Use also for lodgepole pine stands. For old growth stands use height of dominants at age 300 years.

⁴Average total height in feet and meters of dominant trees at 100 years of age.

⁵Average total height in feet and meters of dominant trees at 300 years of age.

CALIFORNIA FOREST PRACTICE RULES

Article 5 Standardized Stocking Sampling Procedures

1070 Stocking Sampling

The objective of this article is to describe the stocking sampling procedures that the Timber Owner or his agent shall use to determine if the stocking standards of the Act and Rules have been met following the completion of a timber operation.

1071 Minimum Stocking Standards

Within five years after the completion of Timber Operations or as otherwise specified in the Rules, a report of stocking on the entire area logged under the plan and shown on a revised map shall be filed with the Director by the Timber Owner or the agent thereof. If stocking is required to be met upon completion of Timber Operations the stocking report shall be submitted within six months of the completion of operations.

The minimum acceptable stocking standards on logged areas which were acceptably stocked prior to harvest are those specified in the Coast, Northern, and Southern Forest District Rules. If not otherwise specified, the following minimum standards apply:

(a) On Site I Timberlands as defined by the Board, the average residual basal area, measured in stems one inch or larger in diameter shall be at least 85 square feet per acre; or on Site II or lower shall be at least 50 sq. ft. per acre; or

(b) The area contains an average point count as specified in 14 CCR §§ 912.7, 932.7 and 952.7, as appropriate. See 14 CCR §§ 912.7, 932.7 and 952.7 for information for the point count values of various size trees and for determining how sprouts will be counted toward meeting Stocking requirements.

1072 Stocking Sampling Procedures

The procedures set forth in this article shall be adhered to when sampling for stocking. More than one procedure for sampling may be used on plans where more than one regeneration method or intermediate treatment is used in the Timber Operations.

The sampling procedures are divided into the following categories:

(a) Basal Area Stocking Sampling Procedure: This procedure shall be used where it is necessary to determine whether the specific basal area standards for such situations as the selection and shelterwood (preparatory steps) regeneration methods and commercial thinning intermediate treatment have been met.

(b) Point Count Stocking Sampling Procedure: This procedure shall be used where it is necessary to determine whether specific point count standards must be met. For example, the procedure can be used for the clearcut and seed tree regeneration methods.

(c) Combination Stocking Sampling Procedure: This procedure shall be used where stocking standards can be met using either basal area or point count, such as for the sanitation-salvage intermediate treatment, alternative prescriptions, or where exceptions to the stocking standards have been provided for in the Rules and are specified in the plan.

(d) Waiver Request Procedure: This procedure may be used to request from the Director a waiver of sampling procedures provided in 14 CCR 1072 (a), (b), or (c) where, based upon an RPF's, an RPF supervised designee's, or owner of Timberland's inspection, he/she has determined that the stocking requirements of the Act and Rules have obviously been met.

1072.1 Number of Plots Required

There shall be at least one plot per acre, with a minimum of 20 plots, for each timber operating area sampled. The Timber Owner or his/her agent is encouraged, in lieu of sampling the entire logged area or area being sampled, to delineate by ocular estimate the least stocked 40 acres (16.187 ha) of the logged area or area being sampled and sample this area to determine if it is acceptably stocked. If the least stocked area sampled is determined to be acceptably stocked in accordance with these regulations, the entire logged area, or area being sampled, shall be assumed to be acceptably stocked. If the area sampled is not acceptably stocked the area sampled shall be regenerated to bring it into conformance and the remainder of the logged area shall be sampled, or the next least stocked 40 acres (16.187 ha) shall be sampled to determine whether the rest of the logged area is acceptably stocked.

CALIFORNIA FOREST PRACTICE RULES

The Director, in making the stocking inspection specified in PRC 4588 may, independent of the sample specified in the Report of Stocking, sample what he determines is the least stocked 40 acres (16.187 ha) of the logged area to determine if the area is stocked.

1072.2 Plot Layout

Plots shall be placed on the area being sampled in a uniform grid. The grid shall be considered uniform if the distance between lines does not exceed by two and one half times the distance between plots on the lines.

The starting point of each plot line shall be referenced to a survey corner if convenient or to a suitable, readily locatable permanent landmark and shall be indicated in the Report of Stocking and flagged in the field. The compass bearings shall be recorded in the Report of Stocking.

1072.3 Equipment

The following equipment and methods for measuring distance are acceptable when basal area, point count, or combination stocking sampling procedures are used. Hand compass and pacing may be used for locating plot centers. A measuring tape or other calibrated measuring device shall be used for determining the radius of plots. For basal area and combination stocking sample procedures, an angle-gauge, wedge prism, or other device capable of measuring ocularly a predetermined angle (to determine basal area) will normally be needed.

1072.4 Exclusions

Roads and Landings that will not be regenerated, Meadows and Wet Areas, rocky areas, and areas not normally bearing timber shall not be used as plot centers for sampling purposes. Stream protection zones may be excluded from the sample where stocking cannot be achieved due to legal restrictions on regenerating the zone and it is explained in the stocking report. Notwithstanding the provisions of 14 CCR 1072.2, a random right/left offset from the plot center may be used. Alternatively, the plot may be treated as an unstocked plot for purposes of determining acceptable stocking. The reason for the offset shall be stated in the stocking report.

Offsets shall be in one-half chain (33 ft.) (10.06m) intervals at a right angle to the plot line with a maximum distance of 1.5 chains (99 ft.) (30.19m) allowed. The direction and distance of the offset, if any, shall be note on the plot sheet.

1072.5 Basal Area Stocking Sampling Procedure

The silvicultural Rules of each forest district and the Act contain basal stocking standards to be met following the completion of a timber operation. The following procedure shall be used to determine if these stocking standards have been met: One or more basal area factors suitable for determining stocking shall be used. The same basal area factor shall be used on all of the plots on a sampling area. A countable tree for basal area is described in PRC 4528. If each plot has a minimum basal area equal to or greater than that specified in 1071 (a), or as required by the Rules if different, then the plot shall be counted as stocked.

1072.6 Point Count Stocking Sampling Procedure

The silvicultural Rules of each forest district and the Act contain point count Stocking Standards to be met following the completion of a timber operation. The following procedure shall be used to determine if these Stocking Standards have been met.

Since there are separate values for three different size classes, three circular concentric plots may be needed at each plot center. The following standards are for each Forest District listed below:

(a) Coast Forest District (two hundred (200) point count)

(1) For trees counted as one point each, a plot with an 8.33 foot radius is used (1/200th of an acre).

If a countable tree of a value of at least one point is found in the plot, it is stocked, so recorded, and the Timber Owner or agent thereof moves on to the next plot center. If no Countable Tree is found, the next concentric plot is measured.

(2) For trees counted as two (2) points each, a plot with an 11.78 foot radius is used (1/100th of an acre). If a Countable Tree of a value of at least two (2) points is found in the plot, it is stocked, so recorded, and the Timber Owner or the agent thereof moves on to the next plot center. If no Countable Tree is found, the next larger concentric plot is measured.

CALIFORNIA FOREST PRACTICE RULES

(3) For trees counted as four (4) points each, a plot with a 16.65 foot radius is used (1/50th of an acre). If a countable tree of a value of at least four (4) points is found in the plot, it is stocked. If no countable trees of the required sizes are found in the three (3) concentric plots, the plot center is recorded as being unstocked and the Timber Owner or agent thereof moves on to the next plot center. For point counts of one hundred twenty-five (125) per acre, the three (3) concentric circular plot radius sizes are: 10.53 feet (1/125th of an acre), 14.89 feet (1/62.5th of an acre), and 21.06 feet (1/31.25th of an acre). For point counts of one hundred (100) per acre, the three (3) concentric circular plot radius sizes are: 11.78 feet (1/100th of an acre), 16.65 feet (1/50th of an acre), 23.55 feet (1/25th of an acre).

(4) The point count values of various size trees and for determining how sprouts will be counted is found in 14 CCR 912.7.

(b) Northern and Southern (one hundred twenty-five (125) point count)

(1) For trees counted as one (1) point each, a plot with a 10.53 foot radius is used (1/125th of an acre). If a Countable Tree of a value of at least one (1) point is found in the plot, it is stocked, so recorded, and the Timber Owner or agent thereof moves on to the next plot center. If no Countable Tree is found, the next concentric plot is measured.

(2) For trees counted as two (2) points each, a plot with a 14.89 foot radius is used (1/62.5th of an acre). If a Countable Tree of a value of at least two (2) points is found in the plot, it is stocked, so recorded, and the Timber Owner or the agent thereof moves on to the next plot center. If no Countable Tree is found, the next larger concentric plot is measured.

(3) For trees counted as three (3) points each, a plot with an 18.24 foot radius is used (1/41.67th of an acre). If a Countable Tree of a value of at least three (3) points is found in the plot, it is stocked. If no Countable Trees of the required sizes are found in the three concentric plots, the plot center is recorded as being unstocked and the Timber Owner or agent thereof moves on to the next plot center. For point counts of one hundred (100) per acre, the three concentric circular plot radius sizes are: 11.78 feet (1/100th of an acre), 16.65 feet (1/50th of an acre), and 20.39 feet (1/33.34th of an acre).

(4) The point count values of various size trees and for determining how sprouts will be counted is found in 14 CCR §§ 932.7 and 952.7.

1072.7 Combination Stocking Sampling Procedure

The procedure is used where the silvicultural Rules of each forest district and the Act allow the stocking standards to be met through combination of point count and basal area. The following procedure shall be used to determine if these stocking standards have been met: At each plot center the Timber Owner or agent thereof shall check for either basal area or countable trees. The same basal area factor shall be used on all plots in the sample. If the plot is not stocked with countable trees as specified in 14 CCR 1072.5, it shall be necessary to sample for countable trees as specified in 14 CCR 1072.6.

1073 Unacceptable Results

(a) No more than five unstocked plots shall be contiguous to each other. A contiguous unstocked plot is any plot within the rectangle constructed around the two adjacent plots on the same line and the three plots adjacent to them on the two nearest lines. See Figure 1073(a).

An unstocked plot shall not be counted as contiguous to another unstocked plot if any of the following occur:

(1) Where, in use of the point count or combination stocking sampling procedure, an unstocked plot has a countable tree located in the largest circular concentric plot described in the procedure.

(2) Where the forest practice Rules allow only the basal area sampling procedure to be used, the continuity of the six contiguous plots may be considered broken if one or more of the contiguous unstocked plots meets the minimum stocking standards of the Act.

(b) If there are more than five unstocked plots contiguous to each other, the sample shall be assumed to be understocked except where application of the following gives a number of less than six.

CALIFORNIA FOREST PRACTICE RULES

$$\frac{(CUP) \times (SA)}{(NPS)} - \frac{(SIP) \times (0.5) \times (SA)}{(NPS)} \text{ is less than } 6$$

CUP---Number of contiguous unstocked plots

SA---Acres in sample area

SIP---Number of stocked intermediate plots

NPS---Number of plots in sample, excluding intermediate plots. An intermediate plot is a plot placed halfway between two unstocked plots in the sample.

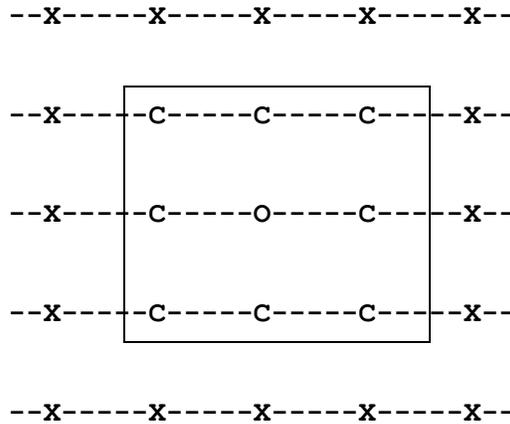

LEGEND

O - Initial Plot

X - Non-Contiguous Plots

C - Contiguous Plots

- - - Survey Line

Figure 1073(a) Example of the rectangle enclosing contiguous plots

(c) If less than 55% of the plots are stocked when using the basal area, point count, or combination stocking sampling procedures, it is assumed that the area being sampled is understocked. The Timber Owner or agent thereof shall delineate the understocked areas in the report of stocking. If the Timber Owner or the agent thereof still believes the area to be stocked, another sample may be run. The second sample shall be laid out in the same manner as the first sample with the additional plots lying halfway between the initial plot lines. For statistical analysis, the two samples shall be combined and analyzed together.

1074 Waiver Request

The basal area, point count and combination stocking sampling procedures may be waived if the Director, and the owner of Timberland or an RPF acting as agent for either the Timber Owner or owner of Timberland, agree that the area is obviously stocked and each of the following conditions is fulfilled:

(a) A request for a waiver of sampling, if filed within five years after completion of Timber Operations, or as otherwise specified in the Board's Rules.

(b) The owner of Timberland or an RPF states in the request for a waiver of sampling to the Director that he/she or that RPF's supervised designee has examined the plan area after completion of Timber Operations and believes those harvested areas for which a waiver of sampling is being requested obviously meet the stocking requirements of the Act and the applicable Rules or regulations of the Board.

1074.1 Waiver Approval

If the Director agrees that an area is obviously stocked, then the sampling procedures are waived. If the Director does not agree that the stocking requirements of the Act and applicable Rules of the Board have been met, the following shall occur:

CALIFORNIA FOREST PRACTICE RULES

(a) The Director shall return the request for a waiver as unacceptable to the owner of Timberland or the RPF making the request.

(b) The Timber Owner or an RPF acting as his/her agent shall use the point count, basal area, or combination stocking sampling procedure, as appropriate on the area, to determine if the stocking requirements of the Act and Rules have been met. The results of this sampling shall be submitted to the Director.

1075 Report of Stocking

A Report of Stocking on a form acceptable to the Director, certifying that the area logged does not meet or meets minimum stocking standards, shall be submitted by the Timber Owner or the agent thereof to the Director within five years after completion of Timber Operations, or as otherwise specified in the Rules. The report shall contain the following information:

- (a) Name, address, and telephone number of Timber Owner(s) or agent thereof.
- (b) The plan number.
- (c) Name of person performing the stocking sampling.
- (d) Map showing the sampling area, by sampling procedure, if more than one procedure is used; the plot locations indicating status as stocked or non-stocked.
- (e) The acreage of each sampling area.
- (f) The number of plot centers installed by sampling procedure.
- (g) The number of stocked plots by sampling procedure.
- (h) Certification by the Timber Owner or agent thereof.
- (i) Either the plot reference data specified in 14 CCR 1072.2 or direction as to where the plot reference can be obtained.

The Timber Owner or agent thereof who files the Report of Stocking shall maintain on file the detailed data on the stocking sampling until such times as a Report of Satisfactory Stocking is issued by the Director. This data shall be available for inspection by the Director and subject to use in enforcement proceedings.

Article 6 Stocking Standards for Substantially Damaged Timberlands

1080 Substantially Damaged Timberlands

[Renumbering of section 1080 to section 895.1 operative 7-1-2000]

1080.1 Stocking Requirements for Substantially Damaged Timberlands

(a) The stocking standards to be maintained or established where substantial damage has occurred prior to the start of Timber Operations, or where such damage has occurred following the start of Timber Operations but before a stocking report has been submitted or approved by the Director, are:

(1) On Sites III and better, the stocking shall consist of at least ten Countable Trees planted for each live tree harvested during conduct of salvage operations following the substantial damage, but need not exceed an average point count of those standards established within 14 CCR § 912.7, 932.7, or 952.7, as appropriate. The number of live trees harvested shall be determined by stump count or by an equivalent procedure proposed by the RPF and approved by the Department.

(2) Where only dead, down, or dying trees were salvage logged following the substantial damage, no restocking is required.

(3) No restocking requirements need be met on substantially damaged Timberlands on Sites IV and V after Timber Operations.

(b) If Stocking Standards were met, but substantial damage occurred before a report of Stocking was approved by the Director, a report of Stocking may be submitted and approved as specified in 14 CCR 1080.4(a).

1080.2 Timber Harvesting Plans for Substantially Damaged Timberlands

Where Timber Operations are to be conducted on any substantially damaged Timberlands, they shall be designated and described in the Timber Harvesting Plan or the Emergency Notice of Timber Operations submitted to the Director.

CALIFORNIA FOREST PRACTICE RULES

1080.3 Stocking Distribution

Any establishment of trees to meet the stocking requirement of 14 CCR 1080 shall be planned to ensure the most feasible utilization of suitable and available growing space and growing stock. The location, spacing, and Site Preparation measures to meet this requirement shall be described in the THP as shall also the area of Timberland qualifying for the stocking standards set forth herein. No more than two restocking efforts shall be required provided that such efforts are accomplished in a good and workman like manner.

1080.4 Stocking Reports for Substantially Damaged Timberlands

(a) In the event that Timberland becomes substantially damaged before a stocking report is submitted to the Director, a report may be submitted by the Timber Owner or his agent stating that the area was adequately stocked prior to the occurrence of substantial damage. A report of stocking for substantially damaged Timberlands shall be a certification to the Director by a Timber Owner or agent thereof that the stocking requirements of 14 CCR 1080.1 (a) and (b) have been met.

(b) The Director shall issue a satisfactory report of stocking if it can be certified, based upon first-hand knowledge, that the area was adequately stocked prior to the destruction of stocking. The owner or agent may appeal the Director's denial of his certification to the Board.

(c) Should only a portion of the plan area be substantially damaged, separate stocking reports (one for the damaged area and one for the undamaged area) may be filed.

1080.5 Time Period to Meet Stocking Requirements

The restocking effort required by 14 CCR 1080.1 shall be accomplished within five years after completion of Timber Operations for salvage or harvest of timber from substantially damaged Timberlands unless a longer period of time is needed and is approved by the Board for a specified area.

Article 6.5 Nonindustrial Timber Management Plan Administration

1090 Rule Application

Where the abbreviation THP, the term Timber Harvesting Plan, or the word plan is used in Chapter 4, Subchapters 1 through 6 and Chapter 4.5 it shall also mean Nonindustrial Timber Management Plan as specified in Article 7.5 of the PRC. In Subchapter 7 this equivalency will occur for all sections except 1031 through 1037.11 and 1039 through 1042.

1090.01. Definitions.

(a) The following definitions apply to this article:

(1) "Designated Agent" means a person granted sole authority, through written certification of all the Nonindustrial Tree Farmer(s) designated in a submitted or approved NTMP, to conduct those activities specifically assigned to a Designated Agent by Rules. A Designated Agent shall only be required when an NTMP includes one or more legal parcels owned by more than a single ownership or has more than one RPF responsible for the NTMP. A single ownership may include, but is not limited to, entities comprised of a single ownership of divided interest, natural persons with undivided interests, or a legally established artificial person (such as liability companies, corporations, partnerships or trusts).

(2) "Nonindustrial Timberland" means, pursuant to PRC § 4593.2(a), Timberland owned by a Nonindustrial Tree Farmer.

(3) "Nonindustrial Tree Farmer" means, pursuant to PRC § 4593.2(b), an owner of Timberland with less than 2,500 acres who has an approved nonindustrial management plan and is not primarily engaged in the manufacture of forest products.

(4) "Notice of Timber Operations" means a nonindustrial timber harvest notice pursuant to PRC § 4593.2(f).

1090.1 Timber Management Plan and Notice of Timber Operations Filing Locations

The NTMP or Notice of Timber Operations for proposed Timber Operations provided for by Article 7.5,

CALIFORNIA FOREST PRACTICE RULES

Chapter 8, Part 2, Division 4 of the PRC (commencing with Sec. 4593) shall be submitted in writing to the Director at the appropriate CAL FIRE Review Team Office having jurisdiction for the Timber Operations, and shall contain the information specified in 14 CCR § 1090.5. [NOTE: For CAL FIRE Review Team Office addresses, see 14 CCR § 1032.]

1090.2 NTMP Submittal and Notice of Preparation

- (a) A Plan shall be submitted by the person who owns the Timberland included in the Plan.
- (b) Where the timber is owned by parties other than the landowner, the landowner shall give prompt written notice of such Plan to those parties.
- (c) The Plan submitter shall prepare and submit to the Director, with the Plan, a notice of preparation to harvest timber (notice of preparation).
 - (1) If any proposed Plan boundary lies within three hundred (300) feet of any property owned by any Person other than the plan submitter, or
 - (2) With any Plan amendment that changes a plan boundary so that the new boundary lies within three hundred (300) feet of any property owned by any Person other than the plan submitter, or
 - (3) With any Plan amendment that changes the silvicultural method if a notice of preparation was required for the plan by condition (1) or (2) above.
- (d) A notice of preparation shall include the following information:
 - (1) The name of the plan submitter.
 - (2) The location of the Plan area by county, section, township, and range, and the approximate direction and distance to the Plan area from the nearest community or well-known landmark.
 - (3) The name of the nearest perennial blue line Stream flowing through or downstream from the Plan area.
 - (4) The acreage of the area to be included in the Plan.
 - (5) The Silvicultural Method(s) proposed.
 - (6) The estimated earliest date that the Director may approve the Plan.
 - (7) A statement that the public may review the Plan at the specified CAL FIRE Review Team Office and a reasonable per page copy fee may be set by the Director for additional copies.
- (e) The Person submitting the Plan shall furnish to the Department at the time of submission of the Plan, a list of all Persons, including their mailing addresses, who hold legal or equitable title to property within three hundred (300) feet of the Plan boundary. Either a list compiled from the latest equalized assessment roll or a list provided by a title insurance company doing business in California shall be deemed sufficient for compliance with the subsection.
- (f) The Department shall mail copies of the notice of preparation within two (2) working days of receipt of the Plan to all persons identified in (e) above.
- (g) Prior to Plan submission, the person submitting the Plan shall post a copy of the notice of preparation at a conspicuous location that is easily visible to the public and near the Plan site. Notwithstanding other Rules, the notices required by 14 CCR 1032.10 of this article shall be completed prior to submission of the NTMP, and within counties with special Rules, (14 CCR, Subchapter 4, Art. 13, commencing with § 924, Subchapter 5, Art. 13, commencing with § 945, and Subchapter 6, Art. 13, commencing with § 965.) the noticing requirements will be the same as for a THP.

1090.3 Notice of Preparation-Distribution by Director

The Director shall distribute copies of each notice of preparation within two (2) working days of receipt to:

- (a) The Office of the County Clerk of the county in which operations are proposed for posting at the customary place for posting environmental affairs.
- (b) The local Ranger Unit headquarters for posting.
- (c) At such other locations as the Director may deem desirable and feasible to provide adequate public notice.
- (d) Any additional distribution of the notice required by the Rules for individual counties.

1090.4 Request for Notification of NTMP or Notice of Timber Operations Submission

- (a) Each applicable CAL FIRE Review Team Office shall maintain a list of NTMPs or Notices of Timber

CALIFORNIA FOREST PRACTICE RULES

Operations submitted each day.

(b) When any person requests notice of submissions of NTMPs, the Director shall provide the person, free of charge, with a copy of the list of NTMPs or Notices of Timber Operations submitted on the date or dates requested. If no specific date is requested, a copy of the lists for the preceding week shall be provided.

1090.5 Contents of NTMP

The plan shall serve three functions: **1)** to provide information the Director needs to determine whether the proposed NTMP conforms to the Rules of the Board; **2)** to provide information and direction for timber management so it complies with the Rules of the Board and the management objectives of the landowner; and **3)** to disclose the potential effects of timber management to the public. For the Plan to serve these functions, it shall, as a minimum, contain the following information:

(a) Name, address, and telephone number of the timberland owner(s) and Designated Agent if one is required.

(b) Name, address, and telephone number of the Timber Owner(s) (if different).

(c) Name, address, telephone number, and registration number of RPF who prepared the Plan.

(d) The District and Subdistrict (if any) in which the NTMP is located.

(e) A description of the plan area within which Timber Operations are to be conducted. The description shall include the following:

(1) U.S. Geological Survey (USGS) Quadrangle name(s) and date(s),

(2) township, range, and section number(s),

(3) county name(s),

(4) CALWATER 2.2 planning watershed number(s), and

(5) approximate acreage.

(f) A description of present and proposed Plan area uses other than timber production.

(g) A description by management unit(s) of the timber stand characteristics including species composition, age classes, projected growth, present stocking level, present volume per acre, size class distribution, stand management history, and potential pest or protection problems. The description shall provide the basis for the information provided.

(h) A description by management unit(s) of the proposed management objectives, including a discussion of projected timber volumes and sizes available for timber harvesting.

(i) A description by management unit(s) of proposed activities to achieve the management objectives. This must include:

(1) Projected frequencies of harvest,

(2) Silvicultural prescriptions for harvesting,

(3) Type of Yarding systems to be used for each area;

(4) Anticipated interim management activities which may result in rule compliance questions (i.e. erosion control maintenance).

(j) The period of time over which growth will be balanced with harvest.

(k) A description of any cultural or historical resources known to exist with a description of possible Impacts and protection methods to be used during Timber Operations.

(l) Whether a Timberland conversion certificate is in effect, its date of expiration, and its identification number.

(m) Whether a timber harvesting plan is on file with the Department for any part of the Plan area and if a report of satisfactory stocking has been issued by the Department (show Plan number).

(n) Information on the presence and protection of any known key habitat or individuals of any threatened or endangered plant or animal species that are listed in CDFW inventories prepared pursuant to the F&GC or any Sensitive Species as designated by the Board in these Rules.

(o) A description of potential Impacts and protections for the quality and beneficial uses of waters within Watercourses, Lakes, Wet Meadows and Other Wet Areas.

(p) A description of soils, surface erosion hazard, mass wasting erosion hazard, and Erosion Control measures.

(q) A description of the existing and proposed road system to be used in implementation of the NTMP.

(r) A description of how the Site Preparation standards and stocking standards will be met.

(s) A description of the proposed Yarding methods including protection of residual trees, watercourse

CALIFORNIA FOREST PRACTICE RULES

crossings, operation on Unstable Areas.

(t) A description of slash treatment for Site Preparation, fire protection and pest protection consideration.

(u) A description of the Cumulative Impacts analysis with supporting information, including Impact of projected harvesting over the life of the Plan.

(v) A copy of the forest practice regulations in effect at the time of submission.

(w) On a USGS quadrangle or equivalent topographical map of a scale not less than two (2") inches to the mile, the following information shall be clearly provided. Additional maps may be required to show specific details, and may be planimetric. Color coding shall not be used. A legend shall be included indicating the meaning of the symbols used. See the district Rules for the appropriate minimum mapping acreages.

(1) Boundaries of management plan(s) and management unit(s).

(2) Boundaries of regeneration methods, intermediate treatments, special harvesting methods, and alternative prescriptions that are to be applied.

(3) Boundaries of Yarding (logging) systems, if more than one system is to be used.

(4) Location of all roads to be used for, or potentially Impacted by, Timber Operations. This shall include:

(A) The classification of all roads as permanent, seasonal, temporary, or proposed for Abandonment.

(B) Roads and Landings located in Watercourses, lakes, WLPZs, marshes, wet meadows, or other wet areas, other than at road watercourse crossings.

(C) Roads that provide access to rock pits and water drafting sites, and the location of water drafting sites.

(D) Public roads within one-quarter ($\frac{1}{4}$) mile of the harvest area.

(E) The location of significant existing or potential erosion sites on all roads and Landings pursuant to 14 CCR § 923.1(e).

(F) Constructed and Reconstructed Logging Road grades greater than fifteen (15) percent for over two hundred (200) continuous feet or Logging Road grades exceeding twenty (20) percent.

(G) Logging Roads across and Landings on Unstable Areas or Connected Headwall Swales.

(H) Excess Material disposal sites on slopes greater than forty (40) percent or on active Unstable Areas.

(I) Logging Roads and Landings across slopes greater than sixty-five (65) percent for one hundred (100) lineal feet or more.

(J) Logging Roads and Landings across slopes greater than fifty (50) percent for one hundred (100) lineal feet or more within one hundred (100) feet of the boundary of a WLPZ.

(K) New Logging Road crossings.

(L) Logging Road crossings to be abandoned.

(5) Probable location of proposed and existing Landings in the Watercourse and lake Protection Zone, and Landings outside the zone that are greater than one-quarter ($\frac{1}{4}$) acre in size or whose construction involves substantial excavation.

(6) Road failures on existing roads to be Reconstructed.

(7) Location of all existing and proposed permanent Watercourse crossing Drainage Structures and temporary crossings on Class I and II Watercourses on roads; if a permanent culvert is involved, its minimum diameter shall be provided.

(8) Location of area(s) of high or extreme erosion hazard rating.

(9) Location of all Watercourses with Class I, II, III, or IV waters.

(10) Location of known Unstable or Slide Areas.

(11) Location of understocked areas and other areas not normally bearing timber to at least a twenty (20) acre minimum, or as specified in the district Rules.

(12) Location of boundaries of timber-site classes needed for determination of stocking standards to be applied, down to at least a ten (10) acre minimum or as specified in the district Rules.

(13) Location of unique areas including, Coastal Commission Special Treatment Areas or any Special Treatment Area.

(14) A soils map.

(15) The location of main ridge tops on the Logging Area suitable for fire suppression efforts that

CALIFORNIA FOREST PRACTICE RULES

will require felling of Snags.

(16) Location of Late Successional Forest Stands.

(17) Boundaries of any areas where Tractor Operations are proposed for use on areas designated for Cable Yarding.

(x) Any additional information that is submitted on separate pages shall be clearly marked "Plan addendum" and shall bear the date on which it was prepared.

(y) Explanation and justification for, and specific measures to be used for, tractor operations on unstable areas, on slopes over sixty-five (65) percent, and on areas where slopes average over fifty (50) percent and the EHR is high or extreme.

(z) Explanation and justification for tractor operations in areas designated for Cable Yarding.

(aa) A winter period operating plan where appropriate.

(bb) Explanation and justification for use of Watercourse, marshes, Wet Meadows and Other Wet areas as Landings, roads, or skid trails.

(cc) Explanation and justification of any in-lieu or alternative practices for Watercourse and lake Protection Zones.

(dd) Explanation of alternatives to standard Rules for harvesting and erosion control.

(ee) Explanation and justification for Landings that exceed the maximum size specified in the Rules.

(ff) Any other information required by the Rules or the Act to be included in the plan. The district Rules provide for exceptions and alternatives to standard requirements that require inclusion of information in the NTMP.

(gg) On a map complying with 14 CCR § 1090.5(w), the locations and classifications of Logging Roads, Logging Road watercourse crossings, and Landings to be abandoned or deactivated shall be shown.

(hh) A certification by the RPF preparing the Plan that they, or a designee personally inspected the area.

1090.6 Notice of Timber Operations

The Nonindustrial Tree Farmer(s), or their Designated Agent (if applicable), who controls any portion of Nonindustrial Timberland and who plans to harvest any of the timber thereon during a given year, shall submit a Notice of Timber Operations including the certification required by PRC § 4594.6 to the appropriate CAL FIRE Review Team Office. Timber Operations may commence immediately unless the Notice of Timber Operations has been filed by mailing, in which case operations may commence three (3) days after the Notice of Timber Operations has been mailed.

1090.7 Notice of Timber Operations Content

The purpose of the Notice of Timber Operations is to provide guidance for implementation of the standards and protective measures in the approved NTMP or most recent amended NTMP and the applicable Rules. For the Notice of Timber Operations to serve these functions, it shall as a minimum, contain the following:

(a) Identification number of the NTMP;

(b) The name and address and phone number of the Nonindustrial Tree Farmer, the Timber Owner, the Designated Agent (if applicable), the RPF and their license number, the LTO and their license number, and the person responsible for on the ground supervision of the Timber Operations.

(c) Expected dates of commencement and completion of Timber Operations.

(d) A legal description of the area of the NTMP, including acreage for by Nonindustrial Tree Farmer(s), on which Timber Operations will be conducted.

(e) Identification of silvicultural prescriptions to be applied.

(f) The type of heavy equipment to be used for Yarding or road construction.

(g) A statement that no archeological sites have been discovered in the harvest area since the approval of the NTMP.

(h) A statement that no listed species have been discovered in the cumulative Impacts assessment area since the approval of the NTMP.

(i) A statement that there have been no physical environmental changes in the cumulative Impacts assessment area that are so significant as to require any amendment of the NTMP.

(j) Special provisions, if any, to protect any unique area within the area of Timber Operations.

(k) Instructions on felling, Yarding, road construction or reconstructions, hauling, erosion control work,

CALIFORNIA FOREST PRACTICE RULES

Site Preparation, erosion control maintenance, Winter Period operations, Watercourse protection measures and slash treatment.

- (l) A certification by the RPF that the Notice of Timber Operations as submitted will carry out:
 - (1) The best management practices for the protection of the beneficial uses of water, soil stability, forest productivity, and wildlife as required by the current Rules of the Board, or
 - (2) Is consistent with the Plan and will not result in significant degradation of the beneficial uses of water, soil stability, forest productivity, or wildlife or be in violation of applicable legal requirements.
- (m) A verification that the LTO has been briefed by the RPF on the content of the Notice of Timber Operations and intentions of implementation to comply with the NTMP.
- (n) On a USGS quadrangle or equivalent map of a scale not less than two (2") inches to the mile, the following information reflecting current conditions pertinent to the Notice of Timber Operations shall be clearly provided. Additional maps may be required to show specific details, and may be planimetric. Color coding shall not be used. A legend shall be included indicating the meaning of the symbols used. See the district Rules for the appropriate minimum mapping acreages.
 - (1) Boundaries of area to be harvested (quadrangle map or its equivalent) by Nonindustrial Tree Farmer(s).
 - (2) Boundaries of areas for specified regeneration methods, intermediate treatments, special harvesting methods, and alternative prescriptions that are to be applied.
 - (3) Boundaries of areas for specified Yarding (logging) systems, if more than one system is to be used.
 - (4) Location of all roads.
 - (A) Classification of all roads.
 - (B) WLPZ roads and landings.
 - (C) Rock pits and water drafting sites.
 - (D) Public roads within one-quarter mile of the harvest area.
 - (E) Logging roads and landings to be abandoned or deactivated.
 - (F) The location of significant existing or potential erosion sites.
 - (5) Location of public roads within the Notice area, and private roads appurtenant to the Timber Operations where such roads are under the ownership or control of the Timberland Owner, and are contiguous with the Notice area, and classification all proposed and existing Logging Roads as permanent, seasonal, or temporary roads.
 - (6) Location of proposed and existing Landings in the Watercourse and lake protection zone, and Landings outside the zone that are greater than 1/4 acre in size or whose construction involves substantial excavation.
 - (7) Road failures on existing roads to be Reconstructed.
 - (8) Location of all existing and proposed watercourse crossings on logging and tractor roads; if a permanent culvert is involved, its minimum diameter shall be provided.
 - (9) Designate areas of high or extreme erosion hazard rating, if more than one.
 - (10) Location of Watercourse with Class I, II, III or IV waters.
 - (11) Location of known unstable areas or slides.
 - (12) Location of unique areas.
 - (13) Excess Material disposal sites on slopes greater than forty (40) percent or on active Unstable Areas.
 - (14) Tractor road watercourse crossings (except dry, temporary Class III).
 - (15) Main ridge tops on the logging area suitable for fire suppression efforts that will require felling of Snags.
 - (16) Boundaries of any areas where Tractor Operations are proposed for use on areas designated for Cable Yarding.
- (o) Any other information the Board provides by regulation to meet its Rules and the standards of this chapter.
- (p) A statement that the Notice of Timber Operations conforms to the provisions of the approved NTMP.

1090.8 NTMP Professional Judgment

CALIFORNIA FOREST PRACTICE RULES

Where the Rules or these regulations provide for the exercise of professional judgment by the RPF or the Director, if there is a disagreement and if requested by either party, they shall confer on the NTMP area during the NTMP review inspection and reach agreement, if possible, on the conditions and standards to be included in the plan.

1090.9 Plan Submitter Responsibility

The plan submitter, or successor in interest, shall:

- (a) Ensure that an RPF conducts any activities which require an RPF.
- (b) Provide the RPF preparing the plan or amendments with complete and correct information regarding pertinent legal rights to, interests in, and responsibilities for land, timber, and access as these affect the planning and conduct of Timber Operations.
- (c) Sign the NTMP certifying knowledge of the plan contents and the requirements of this section.
- (d) Within five (5) working days of change in RPF responsibilities for NTMP implementation or substitution of another RPF, file with the Director a notice which states the RPF's name and registration number, address, and subsequent responsibilities for any RPF required field work, amendment preparation, or operation supervision. Corporations need not file notification because the RPF of record on each document is the responsible person.
- (e) Provide a copy of the approved NTMP and Notice of Timber Operations to the LTO.
- (f) Notify the Director prior to commencement of Site Preparation. Receipt of a burning permit is sufficient notice.
- (g) Provide the RPF preparing the Notice of Timber Operations and LTO each a copy of the current NTMP and subsequent amendments.
- (h) File with the Director a Minor Deviation identifying a Designated Agent that represents the plan submitter(s) at least five (5) days prior to filing the first Notice of Timber Operations, unless already identified in the NTMP.
- (i) File with the Director a Minor Deviation identifying a change in the Designated Agent:
 - (1) Within five (5) working days if active Timber Operations are occurring.
 - (2) Within thirty (30) working days if no active Timber Operations are occurring.
 - (3) The plan submitter(s), or successor(s) in interest, may delegate responsibility for 14 CCR §§ 1090.9(d) through (g) to the Designated Agent, with written notification to the Director.

1090.10 Registered Professional Forester Responsibility

- (a) Upon submission of a NTMP, the RPF who prepares and signs a plan is responsible for the accuracy and completeness of its contents.
- (b) The RPF preparing the plan shall:
 - (1) Inform the Director and landowner by phone or letter if he or she will be attending the review inspection; and
 - (2) Provide the landowner a copy of the Rules of the Board in effect on the date of NTMP approval.
- (c) The RPF preparing the Notice of Timber Operations shall list or describe in the Notice of Timber Operations any work which will be performed by the RPF Notice of Timber Operations preparer or supervised designee. This may include, but is not limited to, field work in identifying Watercourse and lake protection zones or Special Treatment Areas, marking trees, or other activities. The RPF is only responsible for the activities required of the RPF by the Rules of the Board and those activities for which he or she is employed.
- (d) The RPF preparing the Notice of Timber Operations shall, in writing, inform the plan submitter or Designated Agent of their responsibility pursuant to 14 CCR § 1090.9 for compliance with the requirements of the Act and, where applicable, Rules regarding Site Preparation, stocking, and maintenance of roads, Landings, and erosion control facilities.
- (e) The RPF shall without delay notify, in writing, the LTO(s), the plan submitter or the Designated Agent, and the Director of a decision to withdraw professional services from the Plan.

1090.11 Interaction Between RPF and LTO on Notice of Timber Operations

CALIFORNIA FOREST PRACTICE RULES

From the start of the preparation of the Notice of Timber Operation, but before commencement of operations the responsible RPF or Supervised Designee, shall meet with either the LTO, or their representative, who will be on the ground and directly responsible for the Timber Operations. The meeting shall be on site if requested by either the RPF or LTO. If any amendment is incorporated to the Notice of Timber Operations by an RPF after the first meeting, that RPF or supervised designee shall comply with the intent of this section by explaining relevant changes to the LTO. If requested by either the RPF or LTO, another on-site meeting shall take place.

The intent of any such meeting is to assure that the LTO:

- (a) Is advised of any sensitive on-site conditions requiring special care during operations.
- (b) Is advised regarding the intent and applicable provisions of the approved notice including amendments.

1090.12 Licensed Timber Operator Responsibilities

Each Licensed Timber Operator shall:

- (a) Inform the responsible RPF and plan submitter, either in writing or orally, of any site conditions which in the LTO's opinion prevent implementation of the Notice.
- (b) Keep a copy of the applicable approved Notice and amendments available for reference at the site of active Timber Operations.
- (c) Comply with all provisions of the Act, Board Rules and regulations, the applicable Notice and any approved amendments.

1090.13 Notification of Commencement of Operations

For each Notice of Timber Operations submitted, within fifteen days before, and not later than the day of the startup of a timber operation, the Submitter of the Notice, unless the NTMP identifies another person as responsible, shall notify CAL FIRE of the start of Timber Operations. The notification, by telephone or by mail, shall be directed to the appropriate CAL FIRE Unit Headquarters, Forest Practice Inspector, or other designated personnel.

1090.14 NTMP Deviations

(a) "Minor deviations" means any change, minor in scope, in a plan which can reasonably be presumed not to make a significant change in the conduct of Timber Operations and which can reasonably be expected not to significantly adversely affect Nonindustrial Timberland productivity or values relating to soil, water quality, watershed, wildlife, fisheries, range and forage, recreation, and aesthetic enjoyment or to result in a violation of the applicable water quality control plan.

(b) All other changes are presumed to be substantial deviations because they could significantly affect the conduct of Timber Operations and potentially could have a significant adverse effect on timber productivity or values relating to soil, water quality, watershed, wildlife, fisheries, range and forage, recreation, and aesthetic enjoyment. Such actions include, but are not limited to:

- (1) Change in location of Timber Operations or enlargement of the area or volume planned to be cut.
- (2) Change in the Silvicultural Method and Cutting Method on any portion of the Plan area.
- (3) Change in type or location of Yarding system or basic type of equipment.
- (4) Change in location, nature or increase in length of proposed Logging Roads incorporating one or more of the following criteria:

(A) Any road in a Watercourse or Lake Protection Zone or where sidecast will extend into the Watercourse or Lake Protection Zone.

(B) Any road located in an extreme Erosion Hazard Rating area.

(C) Any road where the average side slope exceeds 50%.

(D) Any road where unstable areas, active soil movement, or slide areas must be traversed.

(E) Any increase in gradient allowed by the District Rules as an exception and not provided for in the original Plan.

(F) Any road extension of more than six-hundred (600) feet.

(5) Any use of existing roads not shown in the original Plan when reconstruction work to allow for vehicle travel will be substantial. Substantial work on an existing road means more than minor repair and

CALIFORNIA FOREST PRACTICE RULES

dressings of the travel surface and removal of vegetation to allow for vehicle passage.

- (6) Use of any roads not shown in the Plan which would affect the key habitat of rare or endangered species or other critical wildlife habitat.
- (7) Enlargement of Landings where such enlargement was not justified in the original Plan.
- (8) Any change of operation in, or designation of, the Watercourse or Lake Protection Zone.
- (9) Any downgrading of Watercourse classification.
- (10) A change to Winter Period operations where summer operation were previously specified.

1090.16 Notice NTMP of Filing

(a) The Director shall prepare a notice of filing which shall contain the basic information contained in the Notice of Preparation (14 CCR 1090.2) plus the assigned NTMP number.

(b) Within two (2) working days of the date the plan is filed, the Director shall transmit copies of the notice of filing to:

- (1) The person submitting the plan.
- (2) The office of the County Clerk of the county in which the operations are proposed. The notice of filing shall be posted at the normal place for posting environmental notices.
- (3) The local Ranger Unit headquarters for posting.
- (4) At such other locations as the Director may deem desirable and feasible to provide adequate public notice.
- (5) All public agencies having custodial responsibility for lands within three hundred (300) feet of the NTMP boundary.
- (6) Any Person requesting in writing a copy of the notice of filing.

1090.17 Agency and Public Review for the NTMP

(a) Upon receipt of the filed Plan in accordance with 14 CCR § 1090.16, the Director shall place it, or a true copy thereof, in a file available for public inspection, and shall transmit a copy to CDFW, CGS, and to the appropriate RWQCB, the Department of Parks and Recreation, the county planning agency and, if the areas are within their jurisdiction, to the California Tahoe Regional Planning Agency and the California Coastal Commission and all other agencies having jurisdiction by law over natural resources affected by the Plan.

(b) The Director shall also transmit a copy of any specific Plan to any person who has made a written request therefore.

(c) The Department shall bill such persons for the cost of providing such copies and such monies shall be paid to the Department.

(d) The Director shall invite written comments, and will consider these comments. All comments regarding Plans shall be in writing and shall be addressed to the Director at the appropriate CAL FIRE Review Team Office where the Plan is filed.

(e) Any substantial deviation in the Plan or the inclusion of significant new information (as described in 14 CCR § 895.1), made during the Director's review of the Plan shall require recirculation as described in this section and reopening or extending the public comment period for a minimum of thirty days.

(f) The Director shall take the following steps when significant new information is added to the Plan during the course of Plan review or during the Director's determination period.

- (1) When significant changes are limited to a few sections or portions of the Plan, the Department need only recirculate the sections or portions that have been modified.
- (2) When significant changes are not limited to a few sections of the Plan, the Department shall recirculate the entire Plan.
- (3) The Department shall prepare a Letter of Recirculation which shall include:
 - (A) A brief description of the proposed project and its location. Such information shall

include:

1. The Plan number and County.
2. The names of the Nonindustrial Tree Farmer(s) and the plan Submitter.
3. The location of the Plan area by county, section, township, and range.
4. The name of the nearest major Watercourse or CALWATER 2.2 Watershed ID.

CALIFORNIA FOREST PRACTICE RULES

5. The acres proposed to be harvested.

6. The Silvicultural Systems or Cutting Method to be used.

(B) A summary of changes made to the Plan and a brief description of “Significant New Information” contained in the Plan.

(C) Clarification as to whether the entire Plan or only those recirculated portions of the Plan, are open for public comment.

(D) The starting and ending dates for the review period during which public comments will be received.

(E) The date, time, and place of any scheduled public meetings when known by the lead agency at the time of notice.

(F) The address where copies of the Plan record are available for public review.

(4) The Letter of Recirculation shall be sent to all review team members; any agency, person, or organization that commented on the Plan; and all landowners who received a Notice of Intent (or Preparation).

(5) The Department need only respond to:

(A) Comments received during the initial circulation period that relate to sections or portions of the Plan that were not revised and recirculated, and

(B) Comments received during the recirculation period that relate to the sections or portions of the Plan that were revised and recirculated.

(6) The Department shall include with the Notice of Submissions, a Notice of Recirculation pursuant to 14 CCR § 1032.9.

1090.18 Director's Determination

The Director shall have forty-five (45) days from the date the initial inspection is completed, or in the event the Director determines that such inspection need not be made, forty-five (45) days from the date of filing of an accepted Plan in accordance with 14 CCR 1090.16 or such longer period as may be mutually agreed upon by the Director and the person submitting the Plan, to determine if the Plan is in conformance with the applicable Rules adopted by the Board. The Director shall insure that an interdisciplinary review team has had an opportunity to review each Plan before determining if the Plan conforms to the Rules of the Board. The Director shall consider all written comments regarding the Plan.

1090.19 Review Teams to be Established to Review Timber Management Plan

Interdisciplinary review teams shall be established by the Director to review Plans and assist the Director in the evaluation of proposed NTMP(s) and its Impacts on the environment. The review team composition, function, tasks and procedures shall be the same as those described in 14 CCR 1037.5.

1090.20 Nonconformance of NTMP

If the Director determines that a Plan is not in conformance with the Rules of the Board the Plan shall be returned in accordance with 14 CCR 1054. In addition, the Director shall state any changes and reasonable conditions that in the Director's professional judgment are needed to bring the Plan into conformance with the applicable Rules of the Board and offer to confer with the RPF in order to reach agreement on the conditions necessary to bring the Plan into conformance.

1090.21 Conformance of NTMP

If the Director determines that the Plan is in conformance with the Rules, then the person submitting the plan shall be notified Timber Operations thereunder may only commence after submission of a Notice of Timber Operations as prescribed in 14 CCR 1090.7.

1090.22 Notice of Conformance of the NTMP

Within ten (10) working days of the date a Plan is found in conformance, the Director shall transmit a notice thereof to the agencies and persons referred to in 14 CCR 1090.17 and for posting at the places named in 14 CCR 1090.16. A copy of the notice shall be filed with the Secretary for Resources. The notice of

CALIFORNIA FOREST PRACTICE RULES

conformance shall include a written response of the Director to significant environmental points raised during the evaluation process.

1090.23 Public Inspection

Notices of conformance, pursuant to 14 CCR 1090.22 and notices of approval by the Board, pursuant to 14 CCR 1054, shall be available for public inspection, and a list of such notices shall be posted on a weekly basis in the Office of the Resources Agency. Each such list shall remain posted for a period of thirty (30) days.

1090.24 Amendment

Amendments proposing substantial deviation from an original Plan shall be submitted to the Director in writing by the person who submitted the original Plan, or the successor in interest. Substantial deviations shall not be undertaken until such amendment has been filed and acted upon by the Director in the manner as required in Article 6.5 of Subchapter 7 of these Rules for the original Plan.

1090.25 Report Minor Deviations

Minor deviations may be undertaken by the person who submitted the NTMP or Notice of Timber Operations without submission of an amendment to the Plan and shall be reported immediately in writing to the Director.

Actions described in 14 CCR 1090.14 which are normally presumed to be substantial deviations may, in a given instance, be minor deviations. Actions listed as substantial deviations in 14 CCR 1090.14 but considered to be minor by the plan submitter, may be undertaken only if the plan submitter or the Designated Agent (if applicable) submits the proposed deviation in writing to the Director for review and receives approval.

Approval shall be given if the Director determines that the proposed Minor Deviation conforms to the standards provided in 14 CCR 1090.14(a). The Director shall have five (5) working days to act on the application. If the Director or the representative of the Director does not act within five (5) working days of receipt of such a deviation, Timber Operations may commence pursuant to such amendment.

1090.26 Change of Timberland Owner(s)

(a) Upon a change of ownership of the land described in the NTMP, the transferring Nonindustrial Tree Farmer(s) or the Designated Agent shall provide the acquiring timberland Owner(s) with a written transfer of responsibilities notice that discloses the existence of the NTMP and informs the acquiring timberland owner(s) of the need to notify the Department of the acquiring timberland owner's(s') intent to assume the responsibilities of the NTMP. The transferring Nonindustrial Tree Farmer(s) shall also send the Department a copy of the transfer of responsibilities notice provided to the acquiring timberland owner(s).

(b) If the transferring Nonindustrial Tree Farmer(s) fails to provide the notice required in 14 CCR § 1090.26(a) and the Department discovers the change of ownership, the Department shall provide the acquiring timberland owner(s) with the transfer of responsibilities notice.

(c) The acquiring timberland owner(s) shall have one (1) year from the date of receipt of the transfer of responsibilities notice pursuant to either 14 CCR § 1090.26(a) or 14 CCR § 1090.26(b), whichever is applicable, to notify the Department in writing of their intent to assume the responsibilities of the NTMP. If the Department does not receive notification within this period, the Department may cancel the NTMP.

(d) A violation of this section by a timberland owner(s) or Nonindustrial Tree Farmer(s) does not constitute a crime pursuant to PRC § 4601.

(e) After a Plan is found in conformance with the Rules, the Director may file a notice of stocking requirements on the property with the recorder of the county within which the Plan is located if any area logged under a Notice of Timber Operations has not had a report of satisfactory stocking issued by the Director.

1090.27 Cancellation of Plans

All parties, who submitted plans or their successors, must sign the request to the Director for cancellation of a plan. Once cutting has commenced, the plan may not be canceled except as to lands not harvested.

CALIFORNIA FOREST PRACTICE RULES

1090.28 State Restoration Projects

Notwithstanding any other law, if a person with a NTMP applies for state restoration grant funding for a restoration project that has a significant public benefit, the application shall not be summarily denied on the basis that the project is a required condition of the Plan.

Article 6.75 Sustained Yield Plan

1091.1 Sustained Yield Plan

(a) General. This Article establishes requirements applicable to Sustained Yield, watershed Impacts, and fish and wildlife.

(b) Authority and Intent. This Article carries out the Legislature's direction that the Board adopt regulations to assure the continuous growing and harvesting of commercial forest tree species and to protect the soil, air, fish and wildlife, and water resources in accordance with the policies of the Forest Practice Act (FPA). Those policies include creating and maintaining a system of Timberland regulations and use which ensures that Timberland productivity is maintained, enhanced and restored where feasible and the goal of maximum sustained production (MSP) of high-quality timber products is achieved while giving consideration to environmental and economic values. The Sustained Yield Plan (SYP) may be submitted at the option of the landowner and is intended to supplement the THP process by providing a means for addressing long-term issues of sustained timber production, and cumulative effects analysis which includes issues of fish and wildlife and watershed Impacts on a large landscape basis.

In the interpretation and implementation of this Article, it is recognized that the accuracy of, and therefore the need for, detailed future projections becomes less as the time horizon lengthens. It is not the intent of this Article that speculation shall be promoted such that analyses shall be undertaken which would produce only marginally reliable results or that unneeded data would be gathered. Moreover, it is recognized that in certain cases, landowners, and particularly owners of smaller areas, may not have nor can be reasonably expected to obtain or project information which otherwise might be helpful. It is the intent of this Article that the requirements for informational or analytical support for a SYP shall be guided by the principles of practicality and reasonableness; no information or analysis shall be required which in the light of all applicable factors is not feasible. However, it is the intent of this Article that all potential adverse environmental Impacts resulting from proposed harvesting be described, discussed and analyzed before such operations are allowed. Should such analysis not be included in the SYP, it must be contained in those THPs which rely on the SYP, including any Impact discovered after the SYP is approved.

1091.2 Relation to THPs

If submitted, a SYP shall address issues of sustained timber production, watershed Impacts and fish and wildlife by preparing an SYP for a Management Unit. The SYP shall not replace a THP. However, to the extent that sustained timber production, watershed Impacts and fish and wildlife issues are addressed in the approved SYP, these issues shall be considered to be addressed in the THP; that is the THP may rely upon the SYP.

1091.3 Definitions

"Management Unit" means the part or parts of Timberland ownership which are analyzed together as part of an SYP and may include areas outside of an ownership when addressing watershed and wildlife issues. The Management Unit shall be limited to one forest district. The landowner has the option of including within their management unit their entire ownership within the forest district and any areas outside the district that the Director agrees are part of a logical management unit, or they may divide the ownership into management units based on administrative, regulatory and ecological factors with concurrence from the Director. The Management Unit must include one or more planning watersheds, and may include associated resource assessment areas.

1091.4 Sustained Yield Plan Contents

(a) Contents of SYP. If a SYP is submitted, it shall be prepared under the supervision of and signed by

CALIFORNIA FOREST PRACTICE RULES

an RPF and shall include the following information:

- (1) Name and Address of timber and Timberland Owner.
- (2) Ownership description and location, including legal descriptions and maps depicting the ownership and Management Units which shall be at a scale sufficient to allow the Director to determine the area covered by the SYP.
- (3) Management objectives for resources addressed in the SYP, including timber products.
- (4) General narrative description of the forest types, fish and wildlife habitats and Watercourses and lakes.
- (5) Descriptions of Management Units (e.g., planning watersheds or larger areas) and rationale for Management Unit selection.
- (6) Identification and mapping of Planning watersheds classified as sensitive watersheds and description of the measures taken to protect resources within those watersheds.

1091.4.5 Sustained Timber Production Assessment

(a) Consistent with the protection of soil, water, air, fish and wildlife resources a SYP shall clearly demonstrate how the submitter will achieve maximum sustained production of high quality timber products while giving consideration to regional economic vitality and employment at planned harvest levels during the planning horizon. The average annual projected harvest over any rolling 10-year period, or over appropriately longer time periods for ownerships which project harvesting at intervals less frequently than once every ten years, shall not exceed the long-term sustained yield estimate for a SYP submitter's ownership.

(b) Where a SYP is based upon data on file with the Director, such data shall be updated every 10 years. Proprietary information shall be treated consistent with PRC 21160.

(c) Each sustained timber production assessment shall include:

(1) A summary table of Wildlife Habitat Relationships compositions and stand structure types (WHR), or comparable stand structure types within forest vegetation types with their respective acreage. For an ownership's specific stand structure types, the RPF shall provide a written description of the stand structure and characteristics which define each type, and comparisons of those types to WHR typing. The WHR system, which is herein incorporated by reference, and its uses is described in "A Guide to the California Wildlife Habitat Relationships System", California Department of Fish and Game, March 1988.

(2) An estimate of the long-term sustained yield of the ownership stated in terms of board feet per year or cubic feet per year, or other reasonable measurement consistent with products chosen by the owner, and a description of how the estimate was reached. For ownerships that have not attained long-term sustained yield, the SYP shall estimate and justify the transition period necessary to achieve long-term sustained yield.

(3) A projection of growth and harvest for each WHR type or comparable stand structure type within forest vegetation type over each 10 year period in the planning horizon, and a description in narrative form of the accuracy and methodology used to estimate growth.

(4) A discussion of the accuracy of the inventory data for the management unit and/or ownership. Inventory data, models and growth and harvest projections utilized for harvest scheduling projections shall be available for confidential audits by reviewing agencies along with the basis for such data, including but not limited to the cruise design and sample plot data and statistical validity of such estimates. The SYP shall describe how the submitter will, over time, make reasonable progress to improve inventory estimates for the major WHR or vegetation types, with a goal of achieving standard errors that are no greater than 15% of their respective inventory estimates within the effective period of the SYP.

The major WHR types include all tree-dominated habitats in size classes 4, 5, and 6 with canopy closure classes of S, P, M, and D.

(5) A description of the prescriptions applied to each stand type projected. A narrative discussion of the methods used to project inventory, growth and harvest and WHR type or comparable stand structures type.

(d) The use of Spreadsheet Assisted Resource Analysis (SARA) planning model, Cooperative Redwood Yield Project Timber Output Simulator (CRYPTOS), and California Conifer Timber Output Simulator

CALIFORNIA FOREST PRACTICE RULES

(CACTOS) growth models and WHR types are encouraged in order to aid in the Departmental review.

1091.5 Fish and Wildlife Assessment

The following fish and wildlife issues shall be addressed in an SYP:

(a) Assessment Area. The area for the fish and wildlife Impacts assessment shall be at least the Management Unit under the SYP and may include the entire ownership within a forest district. Areas outside the ownership may be included as necessary to assess the potential individual or cumulative effect of Timber Operations.

In areas with multiple ownerships, landowners may cooperate to establish a management unit and develop a fish and wildlife habitat assessment and management plan.

(b) Impacts to be addressed. The Assessment shall address threatened, endangered and sensitive species and other fish and wildlife species which Timber Operations could adversely Impact, resulting in significant adverse individual or cumulative Impacts. The Assessment shall address, as feasible, such species' habitat needs and the availability, shapes and distribution of habitats in relation to harvest schedule and growth projections and the Impacts of harvesting on such habitats. The SYP shall discuss and include feasible measures planned to avoid or mitigate potentially significant adverse environmental effects on such fish and wildlife. The plan may also discuss positive effects of the timber or Timberland Owner's operations on fish and wildlife.

For the initial ten year period, maps by Management Unit showing significant changes to WHR types or stand structure types that are likely to result from projected Timber Operations shall be included. For the remaining periods within the planning horizon, type changes shall, at a minimum, be discussed in a narrative manner (including tabular analyses by management unit) and may include maps.

(c) Where significant Impacts are identified and feasible mitigation is not available, a THP relying upon the SYP shall address these remaining Impacts. Reasonable Mitigation considered but rejected as infeasible shall be identified.

1091.6 Watershed Assessment and Planning

The following watershed issues shall be addressed in an SYP:

(a) Assessment Area. The minimum assessment area shall be no less than a planning watershed. The assessment area may include multiple watersheds within a Management Unit, and areas outside the ownership may be included.

(b) Impacts Analysis and Mitigation. The Assessment shall include an analysis of potentially significant adverse Impacts, including cumulative Impacts, of the planned operations and other Projects, on water quality, fisheries and aquatic wildlife.

(c) The SYP shall contain a description of the individual planning watersheds in sufficient detail to allow a review of the analysis of Impacts.

(1) For all planning watersheds in the ownership within a forest district descriptions shall include as appropriate:

(A) Estimate of the stand structure type acreage and percent composition of the watershed by decade.

(B) General maps and descriptions of unstable areas and unstable soils known to the plan submitter to be actively or potentially discharging sediment, as well as those mapped by public agencies.

(2) For the initial ten year period, for all planning watersheds in which harvesting will take place, descriptions shall include as appropriate:

(A) Map of existing roads and approximate location and miles of proposed new, Reconstructed and abandoned roads.

(B) Estimate of the SYP submitter's ownership acres of forest types to be harvested by silvicultural method and Yarding method, and the location of submitter's approved and submitted THPs and presently projected future Timber Operations.

(C) A general description of areas known to be sensitive to ground disturbance and present sources of erosion.

(d) The SYP shall also discuss and include feasible measures planned to mitigate or avoid significant adverse Impacts. Where significant Impacts are identified and feasible mitigation is not available, a THP

CALIFORNIA FOREST PRACTICE RULES

relying upon a SYP shall address these remaining Impacts. The SYP submitter shall utilize any one or a combination of methods to assess adverse watershed Impacts including but not limited to:

- (1) Board of Forestry Technical Rule Addendum #2 (14CCR 912.9, 932.9, 952.9).
 - (2) The use of a Cumulative Watershed Effects Analysis, including the Equivalent Roded Area (ERA) method, for screening planning watersheds to determine whether watershed-specific thresholds of concern have been exceeded when appropriate.
 - (3) Other methods proposed in the SYP and approved by the Director.
- (e) Multiple Ownerships. In areas with multiple ownerships, landowners may cooperate to establish a management unit and develop a watershed assessment.

1091.7 Limitation on Information Requirements

Where landowners do not cooperate to develop a watershed or fish and wildlife assessment, or where a management unit is adjacent to lands operated by landowners or Timber Owners who have not submitted a SYP, the information required of a SYP submitter regarding past, present and Reasonably Foreseeable Probable Future Projects shall be limited to information regarding the same ownership, to matters of public record, readily available to the submitter and shall be guided by the principles of practicality and reasonableness. The sufficiency of the information provided in a SYP to evaluate environmental effects shall be judged in light of what is reasonably feasible and necessary.

1091.8 Compliance and Effectiveness Evaluation

The SYP shall include provisions for determining the compliance with and effectiveness of the measures adopted in the SYP to mitigate or avoid significant environmental effects. Such provisions may include evaluation by the SYP submitter and evaluation of affected areas with representative conditions. Progress reports shall be provided periodically to CAL FIRE at their request. Such evaluations shall be developed in consultation with the Director and appropriate review agencies.

1091.9 SYP Effective Period

The effective period of SYP shall be pursuant to PRC §4551.3(a). Renewal of a previously approved SYP may be granted pursuant to PRC §4551.3(a) following agency and public review and upon approval of the Director pursuant to 14 CCR § 1091.15.

1091.10 Review of Sustained Yield Plan (SYP)

The Director shall review and approve or disapprove a SYP. The Director's determination shall be based on multi-disciplinary review used to determine whether the SYP satisfies the requirements of MSP and, in case of watershed and fisheries and wildlife issues, whether the SYP identifies potentially significant adverse Impacts and includes feasible measures necessary to mitigate or avoid such Impacts and is consistent with 14 CCR 897 (b). Where significant Impacts are identified and feasible mitigation is not available, a THP relying upon the SYP shall address these remaining Impacts. Reasonable Mitigation considered but rejected as infeasible shall be identified.

For purposes of PRC 4582.7 submission of a SYP shall be deemed to constitute agreement by the SYP submitter to extend the review and comment periods to the times specified in this article.

(a) Within 20 days of the receipt of an SYP, the Director shall determine if the SYP is in proper order, and meets the informational requirements of the Rules, and if so, the SYP shall be filed. If the SYP is not acceptable for filing the Director shall return the SYP with written specifications of the deficiencies.

Where the Director does not make this determination within 20 days the plan shall be deemed filed. Once the SYP is accepted for filing the Director shall have 45 days or a longer period as mutually agreed to by the submitter and the Director to review and determine if the SYP contains sufficient and complete information to permit further review by the public and other agencies. If it does not, the Director will communicate with the submitter with written specification of the deficiencies including any information necessary to review and analyze the SYP. When the submitter provides adequate written response to each of the deficiencies, the SYP will be scheduled for further review. The Director shall deny the SYP if the information is not provided or is insufficient.

Once the SYP is ready for public and agency review the Director shall schedule a date for the start of a 90

CALIFORNIA FOREST PRACTICE RULES

day or longer period as mutually agreed to by the submitter and the Director.

(b) The Director shall schedule the SYP for the 90 day review as the SYP is determined to be ready for further review while considering departmental workload.

(c) Public Notice of SYP. The Director shall 15 days prior to the start of the 90 day scheduled review transmit notice to the public and agencies consistent with the noticing requirements of sections 1037.5 and 1037.1 b(1-5). The notice shall advise the public of the name of the submitter, geographic location of the SYP, where a copy of the SYP can be reviewed or obtained and when and where the public hearing will be held.

(d) Public Hearing. The Director shall hold a public hearing on the SYP within 45 days from the start of the Public Review Period. The SYP submitter shall participate with the Director in that hearing.

(e) Determination Period. At the end of the review and comment period the Director shall have 30 days to review public input, consider recommendations and mitigation measures of other public agencies, respond in writing to the issues raised and determine if the SYP is in conformance with the Rules. Within this period, the Director shall make a determination of conformance.

(f) SYP Disapproval. If the Director disapproves a SYP, the Director shall provide written reasons for disapproval that conform with section 1054.

1091.11 Appeals

Appeals of SYP's shall be the same as provided in the FPA for THPs. For Head of Agency Appeals, the appealing agency shall have 10 days from the Director's determination date to notify the Board of their intent to appeal. The other requirements of Section 1056(a) shall be submitted to the Board within 30 days after the Director's decision. The 30 days specified in section 1056.2 commence when the appeal statement meets the requirements of 1056(a).

1091.12 Emergency Departures from SYP

In the case of an Emergency as specified in the Rules of the Board (14 CCR 1052.1), the SYP submitter shall notify the Director of such departure in writing and shall comply with Section 1091.13. This notice shall accompany any notice required by Section 1052 for cutting timber on an emergency basis. If an amendment to the SYP is required pursuant to Section 1091.13, it shall be filed within 20 days of the filing of the Emergency Notice. The SYP submitter shall comply with the Emergency Notice requirements.

1091.13 Amendments

Except under emergency circumstances, substantial deviations from the SYP shall not be undertaken in the THPs unless an amendment has been submitted to and approved by the Director following the same procedures as for approving an SYP initially. No THPs may be approved which rely upon a substantial deviation proposed in an amendment to a SYP until such a deviation is approved by the Director.

(a) Substantial Deviations. For purposes of the sustained timber production portion of any SYP, any deviation from the average harvesting projections in any ten-year period which exceeds ten percent, including a deviation caused by changes of ownership and catastrophic events, shall be considered a substantial deviation. For purposes of watershed and fish and wildlife issues, any deviation from the plan which could result in a significant change in Timber Operations and could result in significant adverse effects to watershed or fish and wildlife values shall be considered a substantial deviation.

(b) Minor deviations shall be reported to the Director immediately in writing but shall not require amendment of the plan.

1091.14 Timber Harvest Plans Submitted Within a SYP Management Unit

Each timber harvest plan submitted for an area within an ownership subject to and relying upon an approved SYP shall demonstrate consistency with the SYP and reference the SYP in response to THP questions addressing subjects covered in the SYP. Each THP shall contain feasible mitigation included in the SYP to address identified Impacts. Responses to significant environmental issues raised during THP review on subjects addressed in the SYP shall refer to the SYP. Where new issues or potentially significant adverse effects not addressed in the SYP exist, they shall be identified in the THP or a substantial or minor deviation shall be submitted for the SYP as appropriate. Additional feasible mitigation measures to address

CALIFORNIA FOREST PRACTICE RULES

new issues identified shall be discussed and included in the THP or amendment.

1091.15 Requests for Renewal of Approved Sustained Yield Plans

The Director's determination shall be based upon multi-disciplinary review and evaluation of the elements of the successive SYP submission to determine if the successive SYP satisfies the requirements of MSP, identifies potentially significant adverse Impacts, and includes feasible mitigation measures for avoidance or minimization of such Impacts. The submitter is encouraged to consult with review team agencies prior to submission of a successive SYP for review by the Director.

A request for renewal of an approved SYP shall be submitted to the Director no less than six months prior to expiration of the previously approved SYP and shall be subject to the review timelines specified in 14 CCR § 1091.15, subsections (b) - (f). In the event that the Director cannot meet the specified review timelines and the previously approved SYP expires prior to approval of the successive SYP, the submitter may continue to operate under a THP pursuant to 14 CCR § 913.11 [933.11, 953.11], subsection (c) while the request for SYP renewal remains under review by the Director.

(a) Requests for renewal of an approved SYP shall comply with the SYP content requirements specified in Article 6.75 of Subchapter 7, and shall identify the general nature and location within the document of each substantive difference between the successive SYP submission and the previous approved SYP document. Substantive differences include changes in long term sustained yield estimates for achieving MSP, changes in fish, wildlife, and watershed assessment; and proposed changes to previously approved mitigations, resource protection measures, or operation standards.

(b) Within 20 days of the receipt of a successive SYP submission, the Director shall determine if the document is complete, accurate, and in proper order. If so, the successive SYP submission shall be filed. If the document is not acceptable for filing, the Director shall return it to the submitter with a written explanation of the deficiencies. Where the Director does not make this determination within 20 days, the successive SYP shall be deemed filed.

(c) Once the successive SYP document has been accepted for filing, the Director shall have 60 days or longer, as mutually agreed to by the submitter, to conduct agency and public review of the successive SYP.

(d) Public Notice of Request for Renewal of Approved SYP. The Director shall transmit notice to the public and agencies consistent with the noticing requirements of 14 CCR § 1037.5 and § 1037.1, subsections (b)(1)-(5). The Notice shall advise the public of the name of the submitter, geographic location of the successive SYP, location(s) where a copy of the successive SYP document can be reviewed or obtained, and when and where the public hearing will be held.

(e) Public Hearing. The Director shall hold a public hearing on the successive SYP submission within 30 days from the start of the public review period. The submitter shall participate with the Director in that hearing. The Director shall make a copy of the final draft of the successive SYP document available for public review no sooner than 15 days prior to the close of the agency and public review period.

(f) Director's Determination Period. At the end of the public review and comment period, the Director shall have 15 days to review public input, consider recommendations and mitigation measures of other public agencies, respond in writing to the issues raised, and determine if the successive SYP is in conformance with the Rules. If the document is found to be in conformance, it shall be approved by the Director.

(g) Disapproval of Successive SYP. If the Director does not approve a successive SYP, the Director shall provide written reasons for disapproval that conform with the requirements of 14 CCR § 1054. Appeal of the Director's decision on a successive SYP submission shall be conducted pursuant to 14 CCR § 1091.11.

Article 6.8 Program EIR and THP

1092 Rule Application

(a) Where the abbreviation "THP", the term "Timber Harvesting Plan", or the word "plan" is used in Chapter 4, Subchapters 1 through 6 and Chapter 4.5 it shall also mean "PTHP". In Subchapter 7, this equivalency will occur for all sections except 1032 through 1042.

(b) Within 14 CCR Division 1.5, Chapter 4, Subchapters 4-6, Articles 2, 3, 4, 5, 6, 7, 8, 9, 11, 12, 13, and 14, the operational (specific prescriptive) standards of the Rules shall apply to all Timber Operations conducted under a PTHP. However, as necessary for site-specific project level management, alternate standards can be

CALIFORNIA FOREST PRACTICE RULES

developed which provide equal or better protection to the resource which may be Impacted. These alternate standards may only be accepted by the Director when the PTEIR provides an analysis demonstrating that implementation will result in Impacts which are below the level of significant effect on the environment as defined in the State CEQA Guidelines (14 CCR 15382) and other applicable state laws.

(c) Where the PTEIR has adequately addressed an environmental Impact, the PTHP need only include reference to the PTEIR provisions. Alternate standards may only be used in a PTHP where the analysis of potential Impacts and mitigations in the PTEIR is of such detail that a reasonable person could reach a conclusion that the resulting Impacts would be less than significant.

(d) Within 14 CCR Division 1.5, Chapter 4, Subchapters 1, and 3-6, the planning (performance) standards which are to be incorporated into a THP under the functional equivalent process shall be addressed within the PTEIR to achieve the performance objectives set forth in the intent language of the regulation. The PTEIR shall demonstrate how resource protection set forth in the intent of the Act is provided for on the area encompassed by the PTEIR.

1092.01 PTEIR and PTHP

(a) A Program Timber Harvesting Plan (PTHP) may be filed for ownerships where a PTEIR has been certified by the Director.

(b) The PTEIR shall assess Impacts and provide mitigation for those on and off-site Impacts resulting from Timber Operations involved with an ownership, portion of an ownership, or multiple ownerships. Use of the PTEIR establishes the need for a separate THP process which is provided in this Article. The PTHP relies upon the environmental analysis contained in the PTEIR. All PTHPs shall be accompanied by a checklist which will demonstrate that the proposed operations are within the scope of the PTEIR. The PTHP fulfills the requirements of CEQA by being written within the scope of the analysis contained in the PTEIR. The PTHP also must meet the requirements of the Forest Practice Act and the Rules of the board.

(c) The checklist which accompanies a PTHP must be developed in each PTEIR to address the site specific Impacts and practices for each ownership, portion of an ownership, or multiple ownerships. The checklist shall indicate mitigation to be applied in all areas of resource protection addressed in the PTEIR for individual and cumulative effects, including but not limited to air, wildlife, water, soil, recreation, hazard reduction, pest protection, noise, aesthetics, cultural resources, areas regulated by the board in Sections 4513, 4551, 4551.5, 4561, and 4581 of the Public Resources Code.

(d) Where a PTHP is found by the Director not to be within the scope of the PTEIR, the PTHP submitter has the following alternatives: 1) the PTHP may be modified to be within the scope of the PTEIR, 2) the PTHP may be withdrawn and submitted as a THP under the functional equivalent process, or 3) an addendum, supplement or subsequent PTEIR may be prepared and certified which addresses any remaining Impacts identified in the PTHP.

(e) A PTHP shall be limited to an area with reasonably similar timber geology, soil, topography, climate, and Stream characteristics that would constitute a logical harvesting unit. A PTHP should be limited to that area on which Timber Operations normally will be completed in one 12-month period, but in no case shall it extend beyond five (5) years after the PTHP is determined to be in conformance or otherwise becomes effective under PRC § 4582.7, unless an amendment to extend the effective period is submitted and accepted by the Department per PRC § 4590(a)(1). PTHPs shall be limited to lands within a particular forest district.

1092.02 Director's Guidance for Review of PTEIR

In certifying the PTEIR and adopting the CEQA findings the Director shall certify that the Timberland management described in the PTEIR will achieve the resource protection goals in PRC Sections 4513, 4551, 4561, and 4581 and any goals that may be required by CEQA.

1092.03 Program Timber Harvesting Plan Filing Locations

The PTHP shall be submitted in writing to the Director at the appropriate CAL FIRE Review Team Offices listed in 14 CCR § 1032.

1092.04 Program Timber Harvesting Plan (PTHP) Submittal

(a) A PTHP shall be submitted by the person who owns, leases, contracts, or operates on Timberland and

CALIFORNIA FOREST PRACTICE RULES

plans to harvest timber for commercial purposes.

(b) Where the land or timber is owned or operated by parties other than the person executing the PTHP the person submitting the PTHP shall give prompt written notice of such PTHP to those parties.

(c) The RPF preparing the PTHP shall submit to the Director, with the PTHP, a copy of a Notice of Intent to Harvest: (1) if any proposed boundary lies within 300 feet of any property not owned by the Timberland Owner, or (2) any PTHP amendment that changes a PTHP boundary so that the new boundary lies within 300 ft. of property not owned by the Timberland Owner.

(d) A Notice of Intent shall include the following information:

(1) The names of the Timberland Owner, the RPF who prepared the PTHP, and the PTHP submitter.

(2) The location of the PTHP area by county, section, township, and range, and the approximate direction and distance to the PTHP area from the nearest community or well-known landmark.

(3) The name of and distance from the nearest perennial Watercourse flowing through or downstream from the PTHP area.

(4) The acres proposed to be harvested.

(5) The Silvicultural Systems to be used, including Regeneration Methods, Intermediate Treatments Special Prescriptions, and Alternative Prescriptions.

(6) The estimated earliest date that the Director may approve the PTHP. This is 15 days from receipt of the PTHP by the Department, except in counties for which Rules and regulations have been adopted pursuant to Section 4516.5 and 4516.8 of the PRC where the earliest date the Director may approve the PTHP is 45 days after the receipt of the PTHP by the Department.

(7) A statement that the public may review the PTHP at the appropriate CAL FIRE Review Team Office and that a copy of the PTHP may be obtained from the Department upon payment of the applicable charge.

(8) A map which provides the approximate boundary of the PTHP area, a map legend, and a scale.

(9) A statement that questions or concerns regarding the specific PTHP should be directed to the appropriate CAL FIRE Review Team Office.

(e) The RPF preparing the PTHP shall furnish to the Department at the time of submission of the PTHP the names and mailing addresses of all property owners within 300 ft. of the PTHP boundary. Either a list compiled from the latest equalized assessment roll or a list provided by a title company doing business in California compiled within 60 days of submission of the PTHP shall be deemed sufficient for compliance with the subsection.

(f) The Department shall mail copies of the Notice of Intent within two working days of receipt of the PTHP to all persons identified in (e) above.

(g) Before PTHP submission, the person submitting the PTHP shall post a copy of the Notice of Intent including a map as described in (d)(8) at a conspicuous location on the public road nearest the PTHP site. The Notice shall be on colored paper or identified with colored flagging so as to be easily visible to the public.

(h) A statement of whether there is a known overhead electric power line on the proposed plan area except lines from transformers to service panels.

1092.05 Notice of Intent Distribution

The Director shall distribute copies of each Notice of Intent within two working days of receipt to:

(a) The office of the County Clerk of the county in which operations are proposed for posting at the customary place for posting environmental affairs.

(b) The local Ranger Unit headquarters for posting.

(c) At such other locations as the Director may deem desirable and feasible to provide adequate public notice.

1092.06 Request for Notification of PTHP Submission

(a) Each applicable CAL FIRE Review Team Office shall maintain a list of PTHPs submitted that month.

(b) When any person requests notice of submissions of PTHPs, the Director shall provide the person, free of charge, with a copy of the list of PTHPs submitted on the date or dates requested. If no specific date is

CALIFORNIA FOREST PRACTICE RULES

requested, a copy of the list for the preceding month shall be provided.

1092.07 Request for Information on Domestic Water Supplies

The PTHP submitter shall provide notice by letter to all other landowners within 1,000 feet downstream of the PTHP boundary whose ownership adjoins or includes a Class I, II, or IV Watercourse(s) which receives surface drainage from the proposed Timber Operations. The notice shall request that the PTHP submitter be advised of surface domestic water use from the Watercourse, within the PTHP or within 1,000 feet downstream of the PTHP boundary. When required to notice by letter, the PTHP submitter shall also publish the notice one time in a newspaper of general circulation in the area affected by the proposed project. Such letter and publication shall notify the party of the proposed timber operation and describe its legal location and identify the name, if any, of the Watercourse it may effect. The letter and publication shall request a response by the property owner within ten days of the post-marked date on the letter or the date of publication as appropriate. Copies of either notice, proof of service and publication, and any responses shall be attached to the PTHP when submitted. If domestic use is noted, the PTHP shall contain mitigations necessary to protect domestic water use. The PTHP shall not be submitted until ten days after the above notification(s) have been done. The RPF may propose, with justification and explanation, an exemption to such notification requirements, and the Director may agree.

1092.08 Filing Date

The filing date is the date on which the PTHP is found by the Director to be accurate, complete, and in proper order.

1092.09 PTHP Contents

The purpose of the PTHP is to provide guidance for implementation of the standards and protective measures in the certified PTEIR. For the PTHP to serve these functions it shall contain the following:

- (a) Identification number of the PTEIR and where it can be reviewed;
- (b) The name and address and phone number of the Timberland Owner, the Timber Owner, the RPF, the Licensed Timber Operator and license number and the person responsible for on the ground supervision of the Timber Operations. If the Licensed Timber Operator is not known at the time of plan submission, this information shall be provided prior to the start of Timber Operations.
- (c) Expected dates of commencement and completion of Timber Operations.
- (d) A legal description of the area of the PTHP on which Timber Operations will be conducted. The description shall include the following:
 - (1) U.S. Geological Survey (USGS) Quadrangle name(s) and date(s),
 - (2) township, range, and section number(s),
 - (3) county name(s),
 - (4) CALWATER 2.2 planning watershed number(s), and
 - (5) approximate acreage.
- (e) Identification of silvicultural prescriptions to be applied.
- (f)
 - (1) A confidential Archaeological Addendum as defined in 895.1, if the PTHP covers 3.0 acres or more, or,
 - (2) A statement by the RPF that the area covered by the PTHP has been surveyed in accord with current Forest Practice Rules, and a Confidential Archaeological Addendum was filed and approved as part of the PTEIR associated with the PTHP, or the area covered by the PTHP is less than 3.0 acres.
- (g) A statement that no significant adverse Impacts would occur to any threatened or endangered plant or animal species in the area of the PTHP or that if Timber Operations are being conducted in compliance with an accepted "no take" or authorized incidental "take" procedure, either of which has authorization or concurrence of a wildlife agency acting within its authority under state or federal endangered species acts for a listed species, the PTHP shall so state.
- (h) A statement that there have been no physical environmental changes in the PTHP area that are so significant as to require any addendum or supplement to the PTEIR;
- (i) Special provisions, if any, to protect any unique area within the area of Timber Operations.
- (j) A certification by the RPF that he or she or a supervised designee has personally inspected the PTHP

CALIFORNIA FOREST PRACTICE RULES

area.

(k) A verification that the LTO has been briefed by the RPF or supervised designee on the contents and operational requirements of the PTHP prior to the start of Timber Operations.

(l) On a titled USGS quadrangle or equivalent topographic map of a scale not less than 2" to the mile, the information subsections (1)-(5)(A)5., (6)(A)-(G), if applicable, and (7)-(11) shall be clearly shown.

Additional maps, which may be topographic or planimetric may be used to provide the information required in other subsections or show specific details, and to improve map clarity. The appurtenant roads referenced in subsection (5) may be shown on a map which may be planimetric with a scale as small as one-half inch equals one mile. Color coding shall not be used. A legend shall be included indicating the meaning of the symbols used. See the district Rules for the appropriate minimum mapping acreage.

(1) Boundaries of the area to be harvested.

(2) Boundaries of areas for specified regeneration methods, intermediate treatments, special harvesting methods, and alternative prescriptions that are to be applied.

(3) Boundaries of the Site Class of Timberlands within the PTHP area.

(4) Boundaries of areas for specified Yarding (logging) systems, if more than one system is to be used;

(5) The following Logging Road- and Landing-related features shall be shown on a map of the appropriate type and scale as described in subsection (l) above:

(A) Location of all roads to be used for, or potentially Impacted by, Timber Operations.

This shall include:

1. The classification of all roads as permanent, seasonal, temporary, or proposed for Abandonment .

2. Roads and Landings located in Watercourses, lakes, WLPZs, marshes, Wet Meadows and Other Wet Areas, other than at road Watercourse crossings.

3. Roads that provide access to rock pits and water drafting sites, and the location of water drafting sites.

4. Public roads within one-quarter ($\frac{1}{4}$) mile of the harvest area.

5. The location of significant existing or potential erosion sites on all roads and Landings pursuant to 14 CCR § 923.1(e).

(6) The following shall be mapped at the appropriate scale required under subsection (l) for all constructed and Reconstructed Logging Roads and Landings, unless otherwise noted:

(A) Location of Logging Road grades greater than 15 percent for over 200 continuous feet or Logging Road grades greater than 20 percent.

(B) Location of road failures on existing roads to be Reconstructed.

(C) Location of Logging Roads across or Landings on unstable areas or connected headwall swales.

(D) Location of Landings that require substantial excavation and Landings in excess of one-quarter acre in size.

(E) Location of excess material disposal sites on slopes greater than 40 percent or on active unstable areas.

(F) Location of Logging Roads and Landings across slopes greater than 65 percent for 100 lineal feet or more.

(G) Location of Logging Roads and Landings across slopes greater than 50 percent for 100 lineal feet or more within 100 feet of the boundary of a WLPZ that drains toward the zoned Watercourse or lake.

(7) The location of all new permanent constructed, Reconstructed, and temporary Logging Road Watercourse crossings, including those crossings to be abandoned or deactivated, shall be shown on a map. This requirement may be met by depicting the intersection of a Logging Road and a Watercourse.

(8) Location of all tractor road Watercourse crossings of classified Watercourses except temporary crossings of Class III Watercourses without flowing water during Timber Operations at that crossing.

(9) Location of erosion hazard rating areas, if more than one rating exists.

(10) Location of Watercourses and lakes with Class I, II, III or IV waters.

CALIFORNIA FOREST PRACTICE RULES

(11) Location of known unstable areas or slides. Location of unique areas.

(12) Boundaries of any areas where Tractor Operations are proposed for use on areas designated for Cable Yarding.

(m) Type of Yarding (logging) systems and equipment to be used. Yarding systems will be placed in one or more of the following groups:

(1) Animal

(2) Tractor, skidder, forwarder

(A) Non-tethered

(B) Tethered

(3) Cable

(A) Ground-lead

(B) High-lead

(C) Skyline

(4) Balloon, helicopter

(5) Other, as explained in the PTHP

(n) A completed checklist from the certified PTEIR shall be attached to the PTHP and shall contain a listing of the practices which deviate from standard operational Rules of the Board as presented in the PTEIR.

(o) Explanation and justification of any operational practices which are not specified in the certified PTEIR and which are allowed by the Rules with explanation and justification.

(p) A certification by the RPF preparing the PTHP that the proposed operations are within the scope of the environmental analysis contained in the PTEIR as set forth in 14 CCR 1092 and therefore will not result in any significant environmental Impacts beyond those addressed in the PTEIR.

1092.10 PTHP Professional Judgment

Where the Rules or these regulations provide for the exercise of professional judgment by the RPF or the Director, and there is a disagreement the parties shall confer on the PTHP area, if requested by either party, during the PTHP review and reach agreement, if possible, on the conditions and standards to be included in the PTHP to maintain consistency with the PTEIR.

1092.11 PTHP Submitter Responsibility

The PTHP submitter, or successor in interest, shall:

(a) Ensure that an RPF conducts any activities which require an RPF.

(b) Provide the RPF preparing the PTHP or amendments with complete and correct information regarding pertinent legal rights to, interests in, and responsibilities for land, timber, and access as these affect the planning and conduct of Timber Operations.

(c) Sign the PTHP certifying knowledge of its contents and the requirements of this section.

(d) (1) Retain an RPF who is available to provide professional advice to the LTO and Timberland Owner upon request throughout the active Timber Operations regarding:

(A) the plan,

(B) the Forest Practice Rules, and

(C) other associated regulations pertaining to Timber Operations.

(2) The plan submitter may waive the requirement to retain an RPF to provide professional advice to the LTO and Timberland Owner under the following conditions:

(A) the plan submitter provides authorization to the Timberland Owner to provide advice to the LTO on a continuing basis throughout the active Timber Operations provided that the Timberland Owner is a natural person who personally performs the services of a professional forester and such services are personally performed on lands owned by the Timberland Owner;

(B) the Timberland Owner agrees to be present on the logging area at a sufficient frequency to know the progress of operations and advise the LTO, but not less than once during the life of the plan; and

(C) the plan submitter agrees to provide a copy of the portions of the approved PTHP and any approved operational amendments to the Timberland Owner containing the General Information, Plan of Operations, PTHP Map, Yarding System Map, Erosion Hazard Rating Map and any other information

CALIFORNIA FOREST PRACTICE RULES

deemed by the Timberland Owner to be necessary for providing advice to the LTO regarding Timber Operations.

All agreements and authorizations required under 14 CCR § 1035(d)(2) shall be documented and provided in writing to the Director to be included in the plan.

(e) Within five (5) working days of change in RPF responsibilities for PTHP implementation or substitution of another RPF, file with the Director a notice which states the RPF's name and registration number, address, and subsequent responsibilities for any RPF required field work, amendment preparation, or operation supervision. Corporations need not file notification because the RPF of record on each document is the responsible person.

(f) Provide a copy of the approved PTHP and any amendments to the LTO.

(g) Notify the Director prior to commencement of Site Preparation operations. Receipt of a burning permit is sufficient notice.

(h) Disclose to the LTO, prior to the start of operations, through an on-the-ground meeting, the location and protection measures for any archaeological or historical sites requiring protection if the RPF has submitted written notification to the plan submitter that the plan submitter needs to provide the LTO with this information.

1092.12 Registered Professional Forester Responsibility

(a) Upon submission of a PTHP, the RPF who prepares and signs a PTHP is responsible for the accuracy and completeness of its contents.

(b) The RPF preparing the PTHP shall list or describe in the PTHP any work which will be performed by the PTHP preparer and any additional work requiring an RPF which the PTHP preparer does not intend to perform. This may include, but is not limited to, field work in identifying Watercourse and lake protection zones or Special Treatment Areas, marking trees, or other activities. The RPF is only responsible for the activities for which he or she is employed, or those required by the Rules of the Board. The RPF shall state whether or not he or she has been retained to provide professional advice throughout the Timber Operations.

(c) The RPF preparing the PTHP shall, in writing, inform the PTHP submitter(s) of their responsibility pursuant to Section 1092.11 of this Article and the Timberland Owner(s) of their responsibility for compliance with the requirements of the Act and, where applicable, Board Rules regarding Site Preparation, stocking, and maintenance of roads, Landings, and erosion control facilities.

(d) Upon entering into an agreement to accept responsibility for any part of the preparation or implementation of a plan or any work beyond the preparation of a plan, including providing professional advice; all responsible RPFs shall disclose to the real party of interest for whom the RPF is providing professional forestry services any known current or potential conflict of interest the RPFs have with regard to the timber or land that is subject to operations under the plan. All responsible RPFs shall disclose to the Timberland Owner and plan submitter whether they are the real party of interest for whom the RPF is providing professional forestry services.

(e) Disclosure of newly discovered conflicts of interest an RPF has with regard to the plan submitter, Timberland Owner, Timber Owner, the LTO and timber purchaser, pertaining to the timber or land that is subject to operations under the plan, shall be required as long as an RPF has responsibilities relative to a plan. The disclosure shall include identification of the real party of interest for whom the RPF is providing professional forestry services.

(f) All disclosures made between an RPF and an affected party pursuant to this section may be kept confidential.

(g) An RPF retained by the plan submitter to provide professional advice throughout the Timber Operations shall be present, or ensure that the RPF's supervised designee is present, on the logging area at a sufficient frequency to know the progress of operations and advise the LTO and Timberland Owner, but not less than once during the life of the plan.

(h) An RPF retained by the plan submitter to provide professional advice throughout the Timber Operations shall inform the LTO during operations of any mitigation measures incorporated into the plan that are intended to address operations that have a high likelihood of resulting in immediate, significant and long-term harm to the natural resources of the State if such mitigation measures are not strictly applied to minimize such Impacts.

CALIFORNIA FOREST PRACTICE RULES

(i) The RPF shall without delay notify in writing the LTO, the plan submitter, and the Department of a decision to withdraw professional services from the plan.

1092.13 Interaction Between RPF and LTO on the PTHP

From the start of the PTHP preparation process but before commencement of operations, the responsible RPF, shall meet with either the LTO, or supervised designee who will be on the ground and directly responsible for the harvesting operation. The meeting shall be on site if requested by either the RPF or LTO. If any amendment is incorporated into the PTHP by an RPF after the first meeting, the RPF shall comply with the intent of this section by explaining relevant changes to the LTO; if requested by either the RPF or LTO, another on-site meeting shall take place. The intent of any such meeting is to assure that the LTO:

- (a) Is advised of any sensitive on-site conditions requiring special care during operations.
- (b) Is advised regarding the intent and applicable provisions of the approved PTHP including amendments.

1092.14 Licensed Timber Operator Responsibilities

Each affected Licensed Timber Operator shall:

(a) Sign the plan and major amendments to the plan, or sign and file with the Director a facsimile of such plan or amendments, agreeing to abide by the terms and specifications of the plan. This shall be accomplished prior to implementation of the following; which the affected LTO has responsibility for implementing:

- 1) those operations listed under the plan and
- 2) those operations listed under any amendments proposing substantial deviations from the plan.

(b) Inform the responsible RPF and PTHP submitter, either in writing or orally, of any site conditions which in the LTO's opinion prevent implementation of the PTHP.

(c) Keep a copy of the applicable approved PTHP and amendments available for reference at the site of active Timber Operations. The LTO is not required to possess any confidential addenda to the plan such as the Confidential Archaeological Addendum, nor is the LTO required to keep a copy of such confidential plan addenda at the site of active Timber Operations.

(d) Comply with all provisions of the Act, Board Rules and regulations, the applicable PTHP and any approved amendments or minor deviations.

(e) In the event that the LTO executing the plan was not available to attend the on-site meeting to discuss archaeological site protection with the RPF or supervised designee familiar with on-site conditions pursuant to Section 929.2 [949.2, 969.2] (b), it shall be the responsibility of the LTO executing the plan to inquire with the plan submitter, Timberland Owner, or their authorized agent, RPF who wrote the plan, or the supervised designee familiar with on-site conditions, in order to determine if any mitigation measures or specific operating instructions are contained in the Confidential Archaeological Addendum or any other confidential addendum to the plan.

(f) Provide the RPF responsible for professional advice throughout the Timber Operations an on-site contact employee authorized by the LTO to receive RPF advice.

(g) Keep the RPF responsible for professional advice throughout the Timber Operations advised of the status of timber operation activity.

(1) Within five days before, and not later than the day of the start-up of a timber operation, the LTO shall notify the RPF of the start of Timber Operations.

(2) Within five days before, and not later than the day of the shutdown of a timber operation, the LTO shall notify the RPF of the shutdown of Timber Operations.

(A) The notification of the shutdown of Timber Operations is not required if the period of the shutdown does not extend beyond a weekend, including a nationally designated legal holiday.

(h) Upon receipt of written notice of an RPF's decision to withdraw professional services from the plan, the LTO or on-site contact employee shall cease Timber Operations, except for emergencies and operations needed to protect water quality, until the LTO has received written notice from the plan submitter that another RPF has visited the plan site and accepts responsibility for providing advice regarding the plan as the RPF of record.

CALIFORNIA FOREST PRACTICE RULES

1092.15 Notification of Commencement of Operations

For each calendar year, within fifteen days before, and not later than the day of the startup of a timber operation, the PTHP Submitter, or designee shall notify CAL FIRE of the start of Timber Operations. The notification, by telephone or by mail, shall be directed to the appropriate CAL FIRE Unit Headquarters, Forest Practice Inspector, or other designated personnel.

1092.16 PTHP Review Inspection-Filing Return

Within ten (10) days of the receipt of a PTHP, the Director shall determine if the PTHP is accurate, complete and in proper order, and if so, the PTHP shall be filed. During this same period, the Director shall determine if a preharvest inspection is necessary. If a preharvest inspection is needed, the Department will notify the submitter, the CDFW, the CGS, the appropriate RWQCB, and the LTO who will operate under the plan, if known, to determine if they want to attend and to schedule a mutually agreeable time and date of the inspection. When the Director finds a PTHP inaccurate, incomplete, or otherwise not in proper order, the PTHP shall be returned to the submitter with written specifications of the deficiencies.

1092.17 Notice of PTHP Filing

(a) The Director shall prepare a notice of filing which shall contain the basic information contained in the Notice of Intent (14 CCR 1092.04).

(b) Within two working days of the date the PTHP is filed, the Director shall transmit copies of the Notice of Filing to:

- (1) The person submitting the PTHP.
- (2) The office of the County Clerk of the county in which the operations are proposed. The notice shall be posted at the normal place for posting environmental notices.
- (3) The local Ranger Unit headquarters for posting.
- (4) At such other locations as the Director may deem desirable and feasible to provide adequate public notice.
- (5) All public agencies having custodial responsibility for lands within 300 ft. of the PTHP boundary.
- (6) Anyone else, as required by Public Resources Code 4582.4 and 4582.6.

1092.18 Agency and Public Review for the PTHP

(a) Upon filing a PTHP in accordance with 14 CCR § 1092.16 the Director shall place it, or a true copy thereof, in a file available for public inspection, and shall transmit a copy to the CDFW, the appropriate RWQCB, the CGS, the Department of Parks and Recreation, the county planning agency and, if the areas are within their jurisdiction, to the California Tahoe Regional Planning Agency and the California Coastal Commission.

(b) The Director shall also transmit a copy of any specific PTHP to any person who has made a written request.

(c) The Department shall bill such persons for the cost of providing such copies and such monies shall be paid to the Department.

(d) The Director shall invite written comments, and will consider these comments. All comments should address any areas where there is a question of consistency with the PTEIR, the Act, the applicable Rules of the Board and any other applicable legal requirements. All comments shall be in writing and shall be addressed to the Director at the applicable CAL FIRE Review Team Office where the PTHP was filed.

(e) Any substantial deviation in the plan or the inclusion of significant new information (as described in 14 CCR § 895.1), made during the Director's review of the plan shall require recirculation as described in this section and reopening or extending the public comment period for a minimum of thirty days.

(f) The Director shall take the following steps when significant new information is added to the plan during the course of plan review or during the Director's Determination period.

(1) When significant changes are limited to a few sections or portions of the plan, the Department need only recirculate the sections or portions that have been modified.

(2) When significant changes are not limited to a few sections of the plan, the Department shall recirculate the entire plan.

CALIFORNIA FOREST PRACTICE RULES

(3) The Department shall prepare a Letter of Recirculation which shall include:

(A) A brief description of the proposed project and its location. Such information shall include:

1. The Plan number and County.
2. The names of the Timberland Owner and the Plan Submitter.
3. The location of the plan area by county, section, township, and range.
4. The name of the nearest major Watercourse or CAL Watershed ID.
5. The acres proposed to be harvested.
6. The silvicultural systems to be used.

(B) A summary of changes made to the plan and a brief description of significant new information contained in the plan.

(C) Clarification as to whether the entire plan or only those recirculated portions of the plan, are open for public comment.

(D) The starting and ending dates for the review period during which public comments will be received.

(E) The date, time, and place of any scheduled public meetings when known by the lead agency at the time of notice.

(F) The address where copies of the plan record is available for public review.

(4) The Letter of Recirculation shall be sent to all review team members; any agency, person, or organization that commented on the plan; and all landowners who received a Notice of Intent (or Preparation).

(5) The Department need only respond to:

(A) Comments received during the initial circulation period that relate to sections or portions of the plan that were not revised and recirculated, and

(B) Comments received during the recirculation period that relate to the sections or portions of the plan that were revised and recirculated.

(6) The Department shall include with the Notice of Submissions, a Notice of Recirculation pursuant to 14 CCR § 1032.9.

1092.19 Time Periods for Review.

The Director shall have 30 days from the date the preharvest or initial inspection is completed or in the event the Director determines that such inspection is not needed, 15 days from the date of PTHP filing in accordance with 14 CCR § 1092.16 or such longer period as may be mutually agreed upon by the Director and the person submitting the PTHP, to review the PTHP and to take written comment.

After the public review period has ended, the Director shall have up to fifteen working days, or a longer period mutually agreed upon by the Director and the person submitting the PTHP, to review the public and agency comments, to respond in writing to issues regarding the conformance of the PTHP to the PTEIR and compliance with the Rules of the board and to determine if the PTHP is in conformance with the PTEIR, Forest Practice Act and Board Rules.

1092.20 Director's guidance for review of PTHP

(a) In reviewing a PTHP the Director shall determine if the PTHP is in compliance with the Rules of the board specified in 14 CCR Article 6.8 and whether the proposed activity is within the scope of the PTEIR, and that the PTEIR adequately describes the proposed activity for the purposes of CEQA.

(b) In determining if a PTHP is within the scope of the PTEIR the Director shall determine if one or more of the following conditions exist which requires action under 14 CCR § 1092.01(d):

(1) Where activities are proposed in the PTHP that could result in significant environmental Impacts not considered in the PTEIR.

(2) Where substantial changes have occurred with respect to the circumstances under which the PTHP is undertaken that could result in significant environmental Impacts not previously covered; or

(3) Where new relevant information regarding Impacts or mitigation measures becomes available that shows any of the following:

A) the PTHP would have one or more significant effects not disclosed in the PTEIR.

B) effects previously examined would be substantially more intensive or extensive than

CALIFORNIA FOREST PRACTICE RULES

shown in the PTEIR.

C) mitigation measures or alternatives previously determined to substantially reduce one or more significant Impacts but found to be infeasible would in fact be feasible, or

D) feasible mitigation measures or alternatives not previously considered in the PTEIR were identified that would substantially reduce one or more significant effects.

1092.21 Special Conditions Requiring Disapproval of a PTHP

The Director shall disapprove a PTHP as not conforming to the Rules of the Board if any one of the following conditions exist:

(a) Boundaries of the area to be harvested are not clearly delineated in the PTHP.

(b) Public acquisition of the parcel for purposes which would be impaired by timber harvesting, is legislatively authorized, funded and imminent,

(c) There is evidence that the information contained in the PTHP is incorrect, incomplete or misleading in a material way, or is insufficient to evaluate significant environmental effects. The sufficiency of the information provided in a PTHP to evaluate significant environmental effects shall be judged in light of what is reasonable and necessary.

(d) Implementation of the PTHP as proposed would result in either a "taking" or finding of jeopardy of species listed as rare, threatened or endangered under the state or federal Endangered Species Acts, or would cause significant, long-term damage to listed species. The Director is not required to disapprove a plan if incidental "take" is authorized by a wildlife agency acting within its authority under state or federal endangered species acts.

1092.22 Nonconformance of PTHP

If the Director determines that a PTHP is not within the scope of the PTEIR or is not in conformance with the applicable Rules of the Board the PTHP shall be returned in accordance with 14 CCR 1054. In addition, the Director shall state any changes and reasonable conditions that in the Director's professional judgment are needed to bring the PTHP within the scope of the PTEIR or into conformance with the applicable Rules of the Board and offer to confer with the RPF in order to reach agreement on the conditions necessary to bring the PTHP into conformance.

1092.23 Conformance of PTHP

If the Director determines that the PTHP is within the scope of the PTEIR and is in conformance with the Forest Practice Act and applicable Rules of the Board, then the person submitting the PTHP shall be notified and Timber Operations may commence.

1092.24 Notice of Conformance of the PTHP

Within ten working days of the date a PTHP is found in conformance, the Director shall transmit a notice thereof to the agencies and persons referred to in 14 CCR 1092.18 and for posting at the places named in 14 CCR 1092.17. A copy of the notice shall be filed with the Secretary for Resources. The notice of conformance shall include a written response of the Director to questions of consistency with the PTEIR raised during the evaluation process and shall also contain the following statements:

(a) The proposed activity is within the scope of the PTEIR, and

(b) The PTEIR adequately describes the environmental effects of the activity for the purposes of CEQA.

1092.25 Public Inspection

Notices of Conformance, pursuant to 14 CCR 1092.24 and notices of approval by the Board, pursuant to 14 CCR 1054.8, shall be available for public inspection, and a list of such notices shall be posted on a weekly basis in the Resources Agency office. Each such list shall remain posted for a period of 30 days.

1092.26 Amendment

Changes that are not "minor deviations" as defined in 14 CCR 895.1 are presumed to be substantial deviations if they potentially could have a significant adverse effect on timber productivity or values relating to soil, water quality, watershed, wildlife, fisheries, range and forage, recreation and aesthetic enjoyment that are beyond Impacts identified in the PTEIR. Such actions may include, but are not limited to:

CALIFORNIA FOREST PRACTICE RULES

- (a) Change in location of timber harvesting operations or enlargement of the area to be cut.
- (b) Change in the silvicultural method and cutting system on any portion of the PTHP area.
- (c) Change in type or location of logging (Yarding) system or basic type of equipment.
- (d) Change in location, nature or increase in length of proposed Logging Roads incorporating one or more of the following criteria:
 - (1) Any road in the Watercourse and Lake Protection Zone or where sidecast will extend into the Watercourse and Lake Protection Zone.
 - (2) Any road located in an extreme Erosion Hazard Rating area in the Coast or Northern Forest District, or a high Erosion Hazard Rating-area in the Southern Forest District.
 - (3) Any road where the average side slope exceeds 50%.
 - (4) Any road where unstable areas, active soil movement, or slide areas must be traversed.
 - (5) Any increase in gradient allowed by the District Rules as an exception and not provided for in the original PTHP.
 - (6) Any road extension of more than 600 feet (182.9 m).
- (e) Any use of existing roads not shown in the original PTHP when reconstruction work to allow for vehicle travel will be substantial. Substantial work on an existing road means more than minor repair and dressing of the travel surface and removal of vegetation to allow for vehicle passage.
- (f) Enlargement of Landings where such enlargement was not justified in the original PTHP.
- (g) Any change of operation in, or designation of, the Watercourse and Lake Protection Zone.
- (h) Any downgrading of Stream classification.
- (i) A change to winter operation where summer operations was previously specified.
- (j) Amendments proposing Timber Operations in a PTHP which would place the PTHP outside the scope of the PTEIR must be considered under 14 CCR 1092.01 (d).
- (k) Substantial deviations shall not be undertaken until such amendment has been filed and approved by the Director as required by this Article for the original PTHP.

1092.27 Report Minor Deviations

- (a) Minor deviations as described in 14 CCR § 895.1 shall be submitted in writing to the Director before undertaking the deviation. Actions described in 14 CCR 1092.26 which are normally presumed to be substantial deviations may, in a given instance, be minor deviations. Actions listed as substantial deviations in 14 CCR 1092.26 or discussed in the PTEIR that are considered to be minor by the submitter may be undertaken only if requested in writing to and approved by the Director.
- (b) The Director shall have five working days to determine if the proposed deviation is substantial or minor. Upon the date of receipt, the Director shall send copies of the proposed deviation to the CDFW, the RWQCB, the CGS, and any County which has special Rules adopted under Section 4516.5 of the PRC.
- (c) Where the Director fails to act within the five day period or a determination is made that the proposed deviation is minor, work may commence.
- (d) Where the Director determines the proposed deviation is substantial, the review process in 14 CCR 1092.18 will be followed.

1092.28 Effective Period of the PTHP and PTEIR

- (a) The effective period of the PTHP within the meaning of PRC §§ 4590 and 4591 is the five (5) years following the date the PTHP is determined to be in conformance or otherwise becomes effective pursuant to § 4582.7. Timber Operations shall commence no earlier than the expected date of commencement stated in the PTHP and shall be completed no later than the expected date of completion stated in the PTHP except under the following conditions:
 - (1) An amendment to change the completion date stated in a PTHP has been submitted to the Director at least ten days before the expected date of completion.
 - (2) An amendment to extend the effective period of a PTHP beyond five (5) years is submitted in compliance with PRC § 4590 which includes a map showing clearly the area pertinent to the request for extension.
- (b) Upon receipt of such amendment, the Director shall determine whether the change in date constitutes a substantial deviation of the PTHP. An extension of time is presumed to be a minor deviation, provided the

CALIFORNIA FOREST PRACTICE RULES

extension does not lead to practices that constitute a substantial deviation, as defined Section 1092.26. If the Director determines that such a change of date is a substantial deviation, then the PTHP extension shall not be approved.

(c) The PTEIR will be effective until such time as substantial changes in conditions occur or significant environmental Impacts are identified which are not addressed in the PTEIR. When this occurs the PTEIR may be amended or supplemented to address such new information. Alternatively, PTHP's may be modified to fall within the scope of the PTEIR.

1092.29 Change of Ownership

(a) Any land ownership change upon which there is an unapproved work completion report or stocking report, must be reported to the Director.

(b) Prior to recordation, the existing PTHP Timberland Owner shall notify the acquiring Timberland Owner of the existence of the PTHP, the requirement to notify the Director of the change of ownership, and the acquiring party's responsibility for compliance with the stocking standards of the Act and the applicable Rules of the Board.

(c) The acquiring party shall notify the Director within 10 days of the date title is recorded by the county recorder.

1092.30 Cancellation of PTHP

All parties who submitted the PTHP, or their successors, must sign the request to the Director for cancellation of a PTHP. Once cutting has commenced, the PTHP may not be canceled except as to lands not harvested.

1092.31 Appeals

Appeals of PTHPs shall be the same as provided for in the FPA for THPs. For Head of Agency Appeals, the appealing agency shall have ten days from the Director's determination date to notify the Board of their intent to appeal. The other requirements of Section 1056(a) shall be submitted to the Board within 30 days after the Director's decision. The 30 days specified in Section 1056.2 commence when the appeal statement meets the requirements of 1056(a).

1092.32 Interim Measures for Maximum Sustained Production of High Quality Timber Products

Timberland ownership's of 50,000 acres or more may use subsection (c) of Sections 913.11, 933.11, and 953.11 if a Notice of Preparation for a PTEIR has been filed with the Department. This option may only be used until the PTEIR is certified or rejected by the Department. Maximum Sustained Production will be maintained under the provisions of the PTEIR after certification of the PTEIR by the Department.

Article 6.9. Contents of Road Management Plan

1093. Road Management Plan

The Road Management Plan (RMP) may be submitted as part of a plan at the option of one or more Timberland Owners and is intended to supplement the harvesting plan process through the provision of additional information specific to the long-term management of road systems. The RMP provides a means for addressing long-term issues related to the construction and maintenance of road systems, and analysis of the potential for cumulative adverse Impacts to fish, wildlife and the beneficial uses of water on a broader landscape basis. The extent to which the RMP may be used as part of a cumulative Impacts assessment for Timber Operations proposed in a plan shall be based upon the extent and quality of information provided in the RMP. In evaluating cumulative effects during the preparation of the RMP, if the RPF has adequately considered the factors set forth in the applicable sections of Technical Rule Addendum No. 2, no additional evaluation will be necessary to address these factors in the plan.

1093.1. Guidelines for Orderly Evaluation of Activities Proposed by a RMP

A RMP shall specify measures to be applied to a road system within a Road Management Unit to protect,

CALIFORNIA FOREST PRACTICE RULES

maintain, enhance or restore environmental resources as required by the Forest Practice Act and the Forest Practice Rules, and consistent with other laws and regulations and the objectives of the Timberland Owner. Specific objectives and requirements of a RMP shall include:

- (a) Identification of the long-term access and transportation objectives of the Timberland Owner(s).
- (b) Identification of the beneficial uses of water and the biological resources that could be affected by road management activities, including aquatic and terrestrial wildlife, rare, threatened or endangered species.
- (c) Identification of issues regarding public safety, soil productivity, soil stability, and air quality associated with fugitive dust that could be affected by road management activities.
- (d) Identification, prioritization and implementation of road-related activities that will:
 - (1) avoid or mitigate significant adverse Impacts to resources identified in subsections (b) and (c) above.
 - (2) reduce long-term management costs.
 - (3) protect and maintain the quality and beneficial uses of water (as defined in the applicable Water Quality Control Plan) where they are in good condition, and, insofar as feasible, restore them where they are impaired.
- (e) Identification of noxious weed species (as defined by the State of California Department of Food And Agriculture, Division of Plant Health & Pest Prevention Services, Noxious Weed Species and Noxious Weed Seed Lists A, B, C, and Q at https://www.cdfa.ca.gov/plant/IPC/encycloweedia/weedinfo/winfo_table-sciname.html) when populations of such species could be expanded by road management activities.
- (f) The RMP shall be prepared by an RPF. The RPF may be required to utilize the services of other licensed professionals or qualified experts pursuant to PRC §752(b).
- (g) The information and management practices in a RMP will be scaled to the current and historical condition, and sensitivity of the beneficial uses of water and the resources identified in (b) and (c) above.
- (h) The RMP may be as extensive and detailed as the Timberland Owner desires and may contain approaches to solving problems that include exceptions, in lieu, or alternative practices that meet the requirements of the Forest Practice Rules.

1093.2. Contents of Road Management Plan

The Road Management Plan shall, at a minimum, contain the following information:

- (a) Name and Address of timber and Timberland Owner(s).
- (b) Ownership(s) description and location, including legal descriptions (by Township, Range and Section) and a regional map depicting the ownership(s) and Road Management Units covered by the RMP.
- (c) The RMP shall contain a goals and objectives element, an evaluation element, an operational element, a verification element, and an adaptive management element.
 - (1) The goals and objectives element shall include at least the following:
 - (A) A description of the Timberland Owner's long-term road planning process and objectives.
 - (B) The Timberland Owner's desired future conditions, performance standards, and priorities for the road system and for the beneficial uses of water and other resources needed to attain the objectives of the RMP.
 - (C) The identification of any additional permitting requirements that the submitter proposes to satisfy through the RMP.
 - (D) A description of the Road Management Unit including maps clearly depicting the following information:
 - 1. The ownership boundaries of the area covered by the RMP.
 - 2. The location of existing or proposed roads known at the time of RMP submission.

Maps shall be topographic, at a scale and detail sufficient to allow the Director to evaluate the area covered by the RMP, and may be provided in electronic format.

- (2) The evaluation element shall contain at least the following information:
 - (A) A general description of the watersheds covered by the RMP including information on soils, topography, vegetation, the condition of the watersheds, and the condition of the Watercourses and lakes within the watersheds. This description shall include the current and historic road system as it pertains

CALIFORNIA FOREST PRACTICE RULES

to sediment production, delivery to, and transport within Watercourses and lakes, and the effect of sediment on the beneficial uses of water and other resources.

(B) Identification of significant constraints associated with the road system within the Road Management Unit or planning watershed which may include, but are not limited to, cultural, biological, economic, geographical, geological, legal, and social constraints.

(C) An inventory and assessment of the road system shall be conducted. If an inventory has not been completed, the RMP shall include a prioritized schedule for completion of the inventory. At a minimum, the inventory and assessment shall be complete for the area encompassed in the plan to which the RMP is appended. The inventory and assessment shall include the following:

1. A brief description of the method used to do the inventory and assessment.

2. An inventory of permanent, seasonal and temporary roads, Landings, crossings, and historic roads. The inventory shall include a description of roads within each Road Management Unit, and road system maps at a scale sufficient to clearly show the classification of all roads and their location relative to the beneficial uses of water and other resources that may be affected by roads and Landings. The scale of the map shall be specified in the RMP and approved by the Director.

3. An assessment of the road system related to location, condition, trend, and sensitivity of beneficial uses of water and other resources that may be affected by roads and Landings. The assessment shall include:

a. The road surface drainage network including Watercourse crossings and their relationship to the natural hydrologic system.

b. The ability of permanent Watercourse crossings to accommodate the 100-year flood flow, including debris and sediment loads.

c. The ability of permanent Watercourse crossings to accommodate fish passage at all life stages.

d. The location and identification of known sediment source sites related to inventoried roads, Landings, and drainage structures directly associated with Watercourses and lakes.

e. The identification of any known unstable areas and unstable soils associated with roads or in close proximity to roads.

f. The evaluation of other constraints identified in subsection (2)(B) above as they affect the RMP.

4. The prioritization of any proposed maintenance, repair, improvement or Abandonment of individual components of the overall road system. The road management priorities shall include clear and logical links to the stated objectives and evaluation findings.

a. Road-related sediment sources, including but not limited to road segments and specific road points, shall be prioritized as “High”, “Medium”, and “Low”. The prioritization shall take into account volume of materials that could be delivered to a Watercourse or lake, proximity to a Watercourse or lake (delivery hazard), and Watercourse or lake classification (resource vulnerability).

5. Creation of a treatment schedule for sediment source priority areas.

6. Prioritization of drainage facilities and structures not currently facilitating passage for all life stages of fish.

7. Creation of a schedule for modification of drainage facilities and structures not currently facilitating passage for all life stages of fish.

(D) An evaluation of significant environmental effects that may result from the proposed actions described in the RMP shall be conducted.

(E) An analysis of cumulative effects shall be conducted in conformance with 14 CCR §§ 898, 912.9 [932.9,952.9] and Technical Rule Addendum No. 2.

(3) The operational element shall, at a minimum, address proposed road management operations, stated time frames for actions, clear lines of responsibility for implementation, and schedules to be implemented in a plan, including:

(A) A road construction, reconstruction and use component to ensure that operations occur on a stable operating surface, consistent with 14 CCR § 923.6. This component shall include, at a minimum, restrictions for wet weather operations, surfacing objectives, and provisions for water drafting.

(B) A road maintenance and inspection component that includes a description of erosion

CALIFORNIA FOREST PRACTICE RULES

control and soil stabilization treatments that may be used under the RMP.

(C) A road improvement component, including proposed actions or treatments and an implementation schedule as provided in subsections (2)(C) 4. and 5. above.

(D) A road Abandonment component, if proposed, including provisions for closure and access control.

(E) Contingency plans for addressing emergencies as defined by 14 CCR § 15359.

(F) Actions consistent with the California Forest Practice Rules for Logging Roads and Landings, Title 14, Subchapters 4, 5 & 6, Article 12 [Article 11. Northern District]. The RPF may propose an exception to a standard rule as provided in Article 12 [Article 11. Northern District] to achieve identified goals and objectives where the exception provides equal protection to water quality and minimizes soil erosion.

(4) The verification element shall include the procedures and schedule to be used to:

(A) Monitor implementation of, and verify compliance with, the operational provisions of the RMP.

(B) Monitor the effectiveness and progress of the plan's operational element in achieving the RMP's stated goals and objectives. Such provisions may include evaluation by the RMP submitter and evaluation of affected areas with representative conditions.

(C) Report monitoring and evaluation information developed through subsections (4)(A) and (B) above to the Department on an annual basis or as specified in the RMP and as approved by the Director.

(5) The adaptive management element shall include:

(A) The criteria used to determine when to update and revise the RMP based on new information, scientific reports and data, new legal requirements, monitoring results, and changing environmental conditions.

(B) The process to implement changes to the RMP resulting from new information, scientific reports and data, new legal requirements, monitoring results, and changing environmental conditions.

(C) The method to be used to monitor the progress toward achieving the RMP's goals and objectives pursuant to subsection (4)(C) above.

1093.3. Limitation on Information Requirements

Information requirements shall be guided by the principles of practicality and reasonableness. Where the Management Unit(s) to be included in an RMP contain(s) land or Timber Owner(s) who are not participating in the development and approval of the RMP, the information required of the RMP submitter regarding past, present, and Reasonably Foreseeable Probable Future Projects shall be limited to: 1) information regarding the ownership(s) seeking RMP approval, and 2) matters of public record readily available to the submitter.

1093.4. RMP Effective Period

The effective period of the RMP shall not exceed the effective period of the plan to which the RMP is appended.

1093.6. Notice of Filing

When a RMP is submitted as part of a plan, the Director shall so indicate on the notice of filing.

Article 6.95 Working Forest Management Plan Administration

1094 Rule Application

Where the abbreviation THP, the term Timber Harvesting Plan, or the word Plan is used in Chapter 4, Subchapters 1 through 6 and Chapter 4.5 it shall also mean Working Forest Management Plan as specified in PRC § 4597 et seq. In Subchapter 7 this equivalency will occur for all sections except 1032.7 through 1042 that are not referenced in this Article, or as otherwise specified. Working Forest Landowners shall comply with all applicable regulatory requirements of the State Water Resources Control Board and the appropriate RWQCB.

CALIFORNIA FOREST PRACTICE RULES

1094.1 Working Forest Management Plan and Working Forest Harvest Notice Filing Locations

The Working Forest Management Plan (WFMP) or Working Forest Harvest Notice for proposed Timber Operations, pursuant to PRC § 4597.1 et seq., shall be submitted in writing to the Director at the appropriate CAL FIRE Review Team Office specified under 14 CCR § 1032, and shall contain at a minimum the information specified in 14 CCR §§ 1094.6 or 1094.8, respectively.

1094.2 Definitions

The following definitions apply to this article:

(a) “Designated Agent” means a person granted sole authority, through written certification of all the Working Forest Landowner(s) designated in a submitted or approved WFMP, to conduct those activities specifically assigned to a Designated Agent by Board Rules.

(b) “Late Succession Forest Stands”, pursuant to PRC § 4597.2(g)(3), means stands of dominant and predominant trees that meet the criteria of the California Wildlife Habitat Relationships System class 5D, 5M, or 6 with an open, moderate, or dense canopy closure classification, often with multiple canopy layers, and are at least ten (10) acres in size. Functional characteristics of late succession forest stands include large decadent trees, snags, and large down logs.

(c) “Long Term Sustained Yield (LTSY)”, pursuant to PRC § 4597.1(a), means the average annual growth sustainable by the inventory predicted at the end of a 100-year planning horizon, or a shorter planning horizon if the forest encompassed by the WFMP has reached a balance between growth and yield.

(d) “Major Stand Type”, pursuant to PRC § 4597.1(b), means a stand that occupies an area equal to or greater than 25 percent of a WFMP.

(e) “Management Unit”, pursuant to PRC § 4597.1(c), means a geographically identifiable area delineated for silviculture or management purposes. A Management Unit is intended to reflect an area scheduled for harvest under the Plan in any given year, but may also be designated to address specific resource sensitivities.

(f) “Stand”, pursuant to PRC § 4597.1(d), means a geographically identifiable group of trees sufficiently uniform in age-class distribution, composition, and structure and growing on a site of sufficiently uniform quality to be a distinguishable unit.

(g) “Strata”, pursuant to PRC § 4597.1(e), means a grouping of similar Stands defined for silvicultural or management purposes, usually according to similarities in stand composition, structure, and age.

(h) “Sustained Yield”, pursuant to PRC § 4597.1(f), means the yield of commercial wood that an area of commercial Timberland can produce continuously at a given intensity of management consistent with required environmental protection and that is professionally planned to achieve over time a balance between growth and removal. Sustained Yield management implies continuous production planned so as to achieve, at the earliest practical time, a balance between growth and harvest.

(i) “Uneven aged Management”, pursuant to PRC § 4597.1(g), means forest management with the goal of establishing a well-stocked stand of various age classes, which permits the periodic harvest of individual or small groups of trees to achieve Sustained Yield objectives of the WFMP, and provide for regeneration of trees and maintenance of age class structure.

(j) “Working Forest Harvest Notice”, pursuant to PRC § 4597.1(h), means notice of timber harvest operations, pursuant to an approved WFMP, which meets the requirements of PRC § 4597.11 and 14 CCR § 1094.8.

(k) “Working Forest Landowner”, pursuant to PRC § 4597.1(i), means an owner of Timberland with 10,000 or fewer acres of Timberland who has an approved WFMP and is not primarily engaged in the manufacture of forest products.

(l) “Working Forest Management Plan (WFMP)”, pursuant to PRC § 4597.1(j), means a management plan for Working Forest Timberlands, with objectives of maintaining, restoring, or creating Uneven aged Managed timber stand conditions, achieving Sustained Yield, and promoting forestland stewardship that protects watersheds, fisheries and wildlife habitats, and other important values. Other important values include maintained forest ecosystem processes and services. A Working Forest Management Plan may include multiple Working Forest Landowners, but shall cover no more than 10,000 acres of timberland. The Harvest Area of a Working Forest Management Plan must be contained within a single CALWATER 2.2 hydrologic area.

CALIFORNIA FOREST PRACTICE RULES

(m) "Working Forest Timberlands", pursuant to PRC § 4597.1(k), means Timberlands owned by a Working Forest Landowner(s).

1094.3 WFMP Submittal and Notice of Preparation to Harvest Timber

A WFMP may be submitted to the Department in writing by a person who intends to become a Working Forest Landowner(s) with the long-term objectives of promoting forestland stewardship, uneven aged timber stand(s) and sustained yield through the implementation of a WFMP. The WFMP shall be prepared by a RPF, shall be a public record, shall include all of the specified information pursuant to 14 CCR § 1094.6, and the following conditions shall be met:

- (a)** A Plan shall be submitted by the person(s) who owns the Timberland included in the Plan.
- (b)** Where the timber is owned by parties other than the Timberland Owner(s), the Timberland Owner(s) shall give prompt written notice of such Plan to those parties.
- (c)** The plan submitter(s) shall prepare and submit to the Director, with the Plan, a Notice of Preparation to Harvest Timber if:
 - (1)** Any proposed Plan boundary lies within 300 ft. of any property owned by any person other than the plan submitter, or
 - (2)** Any deviation changes a Plan boundary where the new boundary of the additional area lies within 300 ft. of any property owned by any person other than the plan submitter(s), or
 - (3)** Any deviation changes the silvicultural method if a Notice of Preparation to Harvest Timber was required for the Plan by conditions (1) or (2) above.
- (d)** A Notice of Preparation to Harvest Timber shall include the following information:
 - (1)** The name(s) of the plan submitter(s).
 - (2)** The location of the Plan area by county, section, township, and range, and the approximate direction and distance to the Plan area from the nearest community or well-known landmark.
 - (3)** The name of the nearest perennial blue line Stream flowing through or downstream from the Plan area.
 - (4)** The acreage of the WFMP area and the acreage of the Working Forest Timberlands within which Timber Operations under the WFMP are to be conducted.
 - (5)** The silvicultural method(s) proposed.
 - (6)** The estimated earliest date that the Director may approve the Plan pursuant to 14 CCR § 1094.17.
 - (7)** A statement that the public may review the Plan at the specified CAL FIRE Review Team Office and a reasonable per page copy fee may be set by the Director for additional copies.
- (e)** The person(s) submitting the Plan shall furnish to the Department, at the time of submission of the Plan, a list of all persons, including their mailing addresses, who hold legal or equitable title to property within 300 ft. of the Plan boundary. Either a list compiled from the latest equalized assessment roll or a list provided by a title insurance company doing business in California shall be deemed sufficient for compliance with this subsection.
- (f)** The Department shall mail copies of the Notice of Preparation to Harvest Timber within two (2) working days of receipt of the Plan to all persons identified in (e) above.
- (g)** Prior to Plan submission, the person submitting the Plan shall post a copy of the Notice of Preparation to Harvest Timber at a conspicuous location that is easily visible to the public and near the Plan site. Notwithstanding other Board Rules, the notices required by 14 CCR § 1032.10 shall be completed prior to submission of the WFMP, and within counties with special Rules, (14 CCR Subchapter 4, Article 13 and Subchapter 6, Article 13) the noticing requirements will be the same as for a THP.

1094.4 Notice of Preparation to Harvest Timber-Distribution by Director

The Director shall distribute copies of each Notice of Preparation to Harvest Timber within two (2) working days of receipt to:

- (a)** The Office of the County Clerk, of the county(s) in which operations are proposed, for posting at the customary place for posting environmental affairs.
- (b)** The local Unit headquarters for posting.
- (c)** At such other locations as the Director may deem desirable and feasible to provide adequate public notice.

CALIFORNIA FOREST PRACTICE RULES

(d) Any additional distribution of the Notice of Preparation to Harvest Timber required by the Board Rules for individual counties.

(e) Department's Internet Website.

1094.5 Request for Notification of WFMP or Working Forest Harvest Notice Submission

(a) Each applicable CAL FIRE Review Team Office shall maintain a list of WFMPs or Working Forest Harvest Notice(s) submitted each day.

(b) When any person requests a notice of submission of a WFMP or Working Forest Harvest Notice, the Director shall provide the person, free of charge, with a copy of the list of WFMPs or Working Forest Harvest Notice(s), as the case may be, submitted on the date or dates requested. If no specific date is requested, a copy of the lists for the preceding week shall be provided.

1094.6 Contents of WFMP

The WFMP shall serve three functions: 1) to provide information the Director needs to determine whether the proposed WFMP conforms to the Board Rules; 2) to provide information and direction for timber management so it complies with the Board Rules and the management objectives of the landowner(s); and 3) to disclose the potential effects of timber management to the public. For the WFMP to serve these functions, it shall, at a minimum, contain the following information:

(a) Name, address and telephone number of the Timberland Owner(s).

(b) Name, address and telephone number of the Designated Agent if known at the time of WFMP submission.

(c) Name, address, and telephone number of the Timber Owner(s) (if different than the Timberland Owners).

(d) Name, address, telephone number, and registration number of RPF who prepared the Plan.

(e) A United States Geological Survey quadrangle map or equivalent, of a scale not less than 2" per mile. Additional maps may be required to show specific details, and may be planimetric. Color coding on maps may be used if they are able to be reproduced in black and white and clearly show all details. A legend shall be included indicating the meaning of the symbols used. See the District Rules for the appropriate minimum mapping acreages. The map shall include:

(1) Boundaries of WFMP Management Unit(s). Boundaries of Management Units shall not exceed a single ownership which may include, but is not limited to, entities comprised as a single ownership of divided interest, natural-persons with undivided interests, or a legally established artificial-person (such as limited liability companies, corporations, partnerships, or trusts).

(2) Boundaries of Yarding (logging) systems, if more than one (1) system is to be used.

(3) Boundaries of areas sample marked for each prescribed silvicultural method to be applied.

(4) Location of all roads to be used for, or potentially impacted by, Timber Operations. This shall include:

(A) The classification of all roads as permanent, seasonal, temporary, or deactivated.

(B) Roads and Landings located in Watercourses, Lakes, WLPZs, Wet Meadows or Other Wet Areas, other than at road Watercourse crossings.

(C) Roads that provide access to rock pits and water drafting sites, and the location of water drafting sites.

(D) Public roads within one-quarter (1/4) mile of the harvest area.

(E) The location of significant existing and potential erosion sites on all roads and Landings pursuant to 14 CCR § 923.1(e).

(5) Location of proposed and existing Landings outside the WLPZ that are greater than 1/4 acre in size or whose construction involves substantial excavation.

(6) Location of area(s) of low, moderate, high or extreme erosion hazard ratings.

(7) Location of all Lakes and Watercourses with Class I, II, III, or IV waters.

(8) Location of known unstable areas or slides.

(9) Location of understocked areas and other areas not normally bearing timber to at least a 20-acre minimum, or as specified in the District Rules.

(10) Location of boundaries of timber-site classes needed for determination of stocking standards to

CALIFORNIA FOREST PRACTICE RULES

be applied.

(11) The locations of Logging Roads and Landings to be abandoned or deactivated.

(12) A soils map where available.

(13) Late Successional Forest Stands or Strata

(14) Location of unique areas including Coastal Commission Special Treatment Areas or other Special Treatment Areas and known locations of state or federally listed threatened, candidate, and endangered species; rare plants; Sensitive Species pursuant to 14 CCR § 895.1; and species that meet the criteria under 14 CCR § 15380(d).

(15) The location of all new permanent constructed and Reconstructed and temporary Logging Road Watercourse crossings, including those crossings to be abandoned or deactivated.

(16) For all constructed and Reconstructed Logging Roads and Landings:

(A) Location of Logging Road grades greater than 15 percent for over 200 continuous feet or Logging Road grades exceeding 20 percent.

(B) Locations of Logging Road failures on existing Logging Roads to be Reconstructed.

(C) Location of Logging Roads across and Landings on unstable areas or connected headwall swales.

(D) Location of excess material disposal sites on slopes greater than 40 percent or on active unstable areas.

(E) Location of Logging Roads and Landings across slopes greater than 65 percent for 100 lineal feet or more.

(F) Location of Logging Roads and Landings across slopes greater than 50 percent for 100 lineal feet or more within 100 feet of the boundary of a WLPZ that drains toward the zoned Watercourse or lake.

(17) Location of main ridge tops on the logging area suitable for fire suppression efforts that will require the felling of snags.

(18) Location of any in lieu use of heavy equipment and location of tractor roads in Watercourses, lakes, WLPZs, marshes, Wet Meadows and Other Wet Areas, except where the WFMP has a standard operating practice(s) pursuant to 14 CCR § 1094.6 (jj).

(19) Boundaries of any areas where Tractor Operations are proposed for use on areas designated for Cable Yarding.

(f) A description of the Plan area within which Timber Operations are to be conducted, except as otherwise specified. The description shall include the following:

(1) Township, range, and section number(s) and approximate Plan acreage,

(2) County name(s),

(3) CALWATER v2.2 planning watershed number(s) and hydrologic area number,

(4) The forest district and subdistrict (if any) in which the WFMP is located.

(5) A description of present and proposed Plan area uses other than timber production.

(g) A description by the RPF of the inventory design and standards which, at a minimum, shall include:

(1) The baseline conditions found on the WFMP and the future conditions and planning horizon associated with the estimate of LTSY.

(2) A description of the design of inventory plots or strips, cruise lines and reference points between plots or strips, that are sufficient to facilitate initial review of the WFMP.

(3) The type of projections or models used for projecting growth and yield appropriate for stand conditions and estimated period of time to achieve LTSY.

(h) A description of the inventory design and timber stand stratification criteria that demonstrates that the inventory supporting the growth and yield calculations used to determine LTSY by volume for the WFMPs meets the following minimum standards:

(1) For Major Stand Type(s) or Strata, the inventory estimate shall be within fifteen (15) percent of the mean at one (1) standard error.

(2) For Stand(s) or Strata that make up greater than ten (10) percent and less than twenty five (25) percent of the WFMP area, the estimate shall be no greater than twenty five (25) percent of the mean at one (1) standard error.

(3) Inventory estimates and growth and yield shall be projected for the purposes of determining

CALIFORNIA FOREST PRACTICE RULES

LTSY and volumes available for harvest by Stand or Strata and aggregated for the area covered by the WFMP to develop the LTSY estimate. LTSY estimates shall reasonably reflect constraints applicable to the Working Forest Timberlands on forest management activities. Reasonable constraints shall include biologic and economic factors, while accounting for limits on productivity due to constraints imposed from consideration of other forest values, including but not limited to, recreation, watershed, wildlife, range and forage, fisheries, regional economic activity, employment and aesthetic enjoyment.

- (i) A description of the property and planned activities including:
 - (1) Acres of Stands, Strata and Major Stand Types.
 - (2) Projected growth.
 - (3) Existing stand types.
 - (4) Major Stand Types or Strata.
 - (5) Current projected growth by Strata.
 - (6) Silvicultural method(s) to be applied to Strata to achieve LTSY.
 - (7) Existing and projected timber volumes and tree sizes to be available for harvest.
 - (8) Projected frequencies of harvest.
 - (9) Silvicultural method(s) to be applied during the initial harvest(s) and projected future harvest(s), and method(s) used in the projected growth and yield to achieve LTSY.
- (j) All necessary information to demonstrate compliance with Article 12 (commencing with Section 923) of Subchapter 4 of, Article 11 (commencing with Section 943) of Subchapter 5 of, and Article 12 (commencing with Section 963) of Subchapter 6 of, Division 1.5 of Title 14 of the California Code of Regulations, as applicable.
- (k) Special provisions to protect unique areas, if any, within the WFMP area.
- (l) A description of Late Succession Forest Stands, including their biological legacies and hardwoods, in the Plan area, their acreage, composition, structure, and how the total acreage of this type of habitat will be maintained across the Plan area under a constraint of no net loss. Nothing in this requirement shall be interpreted to preclude active management on any given acre of an approved Plan if the management is conducted in a manner that maintains or enhances the overall acreage of Late Succession Forest Stands that existed in the Plan area upon initial Plan approval. An exception to the no net loss constraint may be granted in the event of a catastrophic loss due to emergency factors such as wildfire, insect, and disease activity. The description shall include the following:
 - (1) Retention measures for existing biological legacies such as snags, trees with cavities or basal hollows, and down logs, and address how legacies shall be managed over time as appropriate with the forest type, climate, and Timberland Owner's forest fire fuels and wildlife management objectives.
 - (2) Hardwood tree species and how they will be managed over time.
- (m) Disclosure of:
 - (1) State or federally listed threatened, candidate, endangered, or rare plant or animal species known locations within the biological assessment area and the WFMP, their status and habitats, take avoidance methodologies, enforceable protection measures for species within or adjacent to the WFMP and habitats within the WFMP area, and how forest management will maintain species and habitats over time;
 - (2) Any known locations of plant or animal species pursuant to 14 CCR § 15380(d) within the biological assessment area and the WFMP;
 - (3) Information on the presence and known locations of individual Sensitive Species pursuant to 14 CCR § 895.1 adjacent to or within the WFMP or their key habitats within the WFMP.
- (n) A description of the following for each Management Unit shall contain:
 - (1) Acres by Stand or Strata and estimated growth and yield for each planned harvest entry covering the period of time the LTSY plan establishes as necessary to meet growth and yield objectives. The growth and yield estimates may be based on weighted average of yield for the Major Stand Type(s) or Strata within the area included in the Management Unit and shall include:
 - (A) Existing and Projected timber volumes and tree sizes to be available for harvest.
 - (B) Existing stocking levels, including but not limited to, average conifer and hardwood basal area density and average conifer and hardwood trees per acre.
 - (C) Potential pest and protection problems.
 - (2) Management Unit history.

CALIFORNIA FOREST PRACTICE RULES

(3) Yarding methods to be used.

(o) For LTSY projections that project a reduction, over 100-year planning horizon or shorter planning horizon until growth and yield are balanced, in quadratic mean diameter of trees greater than 12 inches in diameter or a reduced level of inventory for a Major Stand Type or for a Stand or Strata that make up greater than 10 percent and less than 25 percent of the WFMP area, an assessment shall be included that does all of the following:

(1) Addresses state or federally listed threatened, candidate, and endangered species; rare plants; Sensitive Species pursuant to 14 CCR § 895.1; and species that meet the criteria under 14 CCR § 15380(d), that Timber Operations could adversely impact by potential changes to habitat.

(2) Addresses species habitat needs utilizing the “WHR system” described in “A Guide to Wildlife Habitats in California,” California Department of Fish and Wildlife, 1988, herein incorporated by reference, or comparable typing system approved by the Director after consultation with the California Department of Fish and Wildlife.

(3) Addresses constraints to timber management, the impact of the availability and distribution of habitats on the ownership and within the cumulative Impacts assessment area identified in the Plan in relation to the harvest schedule, and the Impacts of the planned management activities utilizing the existing habitat as the baseline for comparison.

(4) Discusses and includes feasible measures planned to avoid or mitigate potentially significant adverse Impacts on fish or wildlife, which can include, but is not limited to, recruitment or retention of large down logs greater than 16 inches in diameter and 20 feet in length, retention of trees with structural features such as basal hollows, cavities, large limbs, or broken tops, retention of hardwoods, and retention or recruitment of snags greater than 24 inches in diameter and 16 feet in height.

(p) A certification by the RPF preparing the Plan that the RPF or the RPF’s Supervised Designee has personally inspected the Plan area and has clearly explained to the Timberland Owner(s) that the Plan is a long-term commitment that may require ongoing investments, including inventory sampling and Logging Road maintenance, for the purpose of managing the Plan.

(q) The WFMP shall describe a future schedule of inventory sampling and analysis of LTSY, which shall consider:

(1) Site class, projected growth and yield and harvest(s).

(2) Original projections or model calibration and accuracy.

(3) Episodic events including disease and drought caused tree mortality, windthrow, fire and reforestation.

(r) A description of any cultural or historical resources known to exist with a description of possible Impacts and protection methods to be used during Timber Operations.

(s) Whether a Timberland conversion certificate is in effect, its date of expiration, and its identification number.

(t) Whether a timber harvesting plan is on file with the Department for any part of the Plan area and if a Report of Satisfactory Stocking has been issued by the Department (show Plan number).

(u) A description of potential Impacts to, and protections for, the quality and beneficial uses of water.

(v) A description of how the Site Preparation standards and stocking standards of the selected silvicultural method, or that level of stocking above the minimum that will achieve long term sustained yield (LTSY), will be met.

(w) A description of Slash treatment for Site Preparation, fire protection and pest protection consideration.

(x) A description of the cumulative Impacts analysis with supporting information, including Impact(s) of projected Timber Operations over the life of the Plan.

(y) The Department shall make available a copy of the California Forest Practice Rules in effect at the time of WFMP approval.

(z) Explanation and justification for, and specific measures to be used for, tractor operations on unstable areas, on slopes over 65%, and in areas where slopes average over 50% where the EHR is high or extreme.

(aa) Explanation and justification for tractor operations in areas designated for cable Yarding.

(bb) Winter period operating plan where appropriate.

(cc) Explanation and justification for use of Landings, Logging Roads and skid trails in the protection zones of Watercourses, Lakes, Wet Meadows and Other Wet Areas.

CALIFORNIA FOREST PRACTICE RULES

(dd) Explanation and justification of any in-lieu or alternative practices for Watercourse and Lake protection.

(ee) Explanation of alternatives to standard Rules for harvesting and erosion control.

(ff) Explanation and justification for Landings that exceed the maximum size specified in the Rules.

(gg) A description of soils, surface erosion hazard, mass wasting erosion hazard, and erosion control measures.

(hh) A description of the existing and proposed road system to be used in implementation of the WFMP, including the diameter of any permanent culverts on Class I, II, or III Watercourses and the methods used to determine the diameter.

(ii) A description of Lakes, Wet Meadows and Other Wet Areas.

(jj) A RPF may propose, and the Director may approve, a standard operating practice(s) that could be utilized in site-specific locations during future operations under an approved WFMP. Standard operating practices are limited to contents pursuant to 14 CCR §§ 1094.6(z) and 1094.6(cc).

(1) A representative sample of each type of proposed standard operating practice(s) shall be flagged in the field by the RPF, or Supervised Designee, and available for field review by the interdisciplinary review team.

(2) For locations where the prescribed standard operating practice(s) will not adequately address the site specific conditions, the RPF, through consultation with the multi-disciplinary review team, may develop alternative mitigations that shall be incorporated into the WFMP through a deviation prior to submittal of a Working Forest Harvest Notice for the area in which the developed mitigation measure(s) applies and is located.

(kk) Proprietary information shall be treated consistent with PRC § 21160 and GOV § 6254.7.

1094.7 Working Forest Harvest Notice

The Designated Agent shall file a Working Forest Harvest Notice with the Department in writing. A Working Forest Harvest Notice shall be filed prior to the harvesting of any timber and shall be effective for a maximum of one (1) year from the date of filing. The Designated Agent shall notify the Working Forest Landowner(s) by certified mail that the Working Forest Harvest Notice has been submitted and shall certify that mailing to the Department. Notwithstanding any other provisions of the FPA, when a RPF certifies by written declaration, on behalf of the Timber Owner(s) or operator(s), that the Working Forest Harvest Notice conforms to and meets the requirements of the approved WFMP under which it is filed, Timber Operations may commence three (3) working days after filing of a Working Forest Harvest Notice. If the Working Forest Harvest Notice has been filed by mailing, operations may commence five (5) working days after the Working Forest Harvest Notice has been mailed.

1094.8 Working Forest Harvest Notice Content

The Working Forest Harvest Notice shall be a public record. The Department shall post the Working Forest Harvest Notice on the Department's Internet Website. All necessary deviations shall be approved by the Director, pursuant to 14 CCR §§ 1094.23 and 1094.24, prior to submission of a Working Forest Harvest Notice. The Working Forest Harvest Notice shall include all of the following information:

(a) Name, address, and telephone number of the Working Forest Landowner(s).

(b) Name, address, and telephone number of the Designated Agent.

(c) Name, address, and telephone number of the Timber Owner(s) (if different from Working Forest Landowner(s)).

(d) Name, address, telephone number and license number of the licensed Timber Operator(s) conducting operations pursuant to the Working Forest Harvest Notice, and the person responsible for on the ground supervision of Timber Operations (if different from the licensed Timber Operator(s)).

(e) Name, address, telephone number and registration number of the RPF preparing the Working Forest Harvest Notice and the name, address, and registration number of the RPF responsible pursuant to 14 CCR § 1094.11 if different.

(f) A legal description of the land, including acreage, on which the work is proposed to be done including the identification number of the WFMP.

(g) A statement that no archaeological sites have been discovered in the harvest area since the approval of

CALIFORNIA FOREST PRACTICE RULES

the WFMP or approved deviations.

(h) A statement that state or federally listed threatened, candidate, and endangered species; rare plants; Sensitive Species pursuant to 14 CCR § 895.1; and species that meet the criteria under 14 CCR § 15380(d), have not been discovered, or are not publicly disclosed in writing, within or adjacent to the logging area, since the approval of the WFMP, unless the approved WFMP is amended pursuant to either 14 CCR § 1094.23 or 14 CCR § 1094.24, consistent with 14 CCR § 1094.8(h)(2). After the initial year the Plan is approved, prior to submitting the Working Forest Harvest Notice, a review shall be conducted of the California Natural Diversity Database or another public database approved by the Director after consultation with the Department of Fish and Wildlife for any species listed as state or federally listed threatened, candidate, and endangered species; rare plants; Sensitive Species pursuant to 14 CCR § 895.1; and species that meet the criteria under 14 CCR § 15380(d). When a Working Forest Harvest Notice is filed after the initial year the Plan is approved, it shall comply with the following:

(1) Documented occurrences obtained from a review of public and readily available sources of species that are state or federally listed threatened, candidate, and endangered species; rare plants; Sensitive Species pursuant to 14 CCR § 895.1; and species that meet the criteria under 14 CCR § 15380(d) within the biological assessment area, and outside the area of Timber Operations, identified in the Working Forest Harvest Notice, and not addressed in the approved Plan shall be submitted to the Director as a minor deviation concurrently with the filing of a Working Forest Harvest Notice.

(2) Documented occurrences of species that are state or federally listed threatened, candidate, and endangered species; rare plants; Sensitive Species pursuant to 14 CCR § 895.1; and species that meet the criteria under 14 CCR § 15380(d) and discovered within the area of Timber Operations, identified in the Working Forest Harvest Notice, and not addressed in the approved Plan shall be submitted to the Director as a deviation to the WFMP, prior to filing a Working Forest Harvest Notice. The deviation shall contain take avoidance and other mitigation measures developed in consultation with the Department and the appropriate listing agency(s), if no such information is currently contained within the approved Plan or incidental take authorization is provided by the appropriate listing agency(s).

(i) A statement that, based on a field evaluation, there are no physical environmental changes in the Working Forest Harvest Notice area that are so significant as to require any deviation of the WFMP.

(j) A certification by the RPF that states either of the following:

(1) The Working Forest Harvest Notice as carried out will protect the beneficial uses of water, including domestic water supplies, soil stability, forest productivity, and wildlife as provided by the Board Rules and other applicable provisions of law.

(2) Compliance with the Board Rules and the provisions of the FPA that were in effect at the time the WFMP was approved will not result in any significant degradation to the beneficial uses of water, including domestic water supplies, soil stability, forest productivity, or wildlife and shall protect all listed species. This paragraph shall only apply if the RPF certifies that adherence to the current or modified Board Rules would cause unreasonable additional expense, pursuant to PRC § 4583, to the Working Forest Landowner(s).

(k) Special provisions to protect unique areas, if any, within the area of Timber Operations.

(l) The expected dates of commencement and completion of Timber Operations during the year.

(m) A statement that the Working Forest Harvest Notice conforms to the provisions of the approved WFMP. If any aspects of the proposed operation are less protective than the current Board Rules and the FPA, an explanation of the deviation and how resource values will be adequately protected.

(n) An updated on erosion control mitigation measures for the Harvest Area and any Appurtenant Roads if conditions have changed since the Working Forest Management Plan was approved. The updated erosion control mitigation measures shall comply with Article 12 (commencing with Section 923) of Subchapter 4 of, Article 11 (commencing with Section 943) of Subchapter 5 of, and Article 12 (commencing with Section 963) of Subchapter 6 of, Division 1.5 of Title 14 of the California Code of Regulations. Additionally, the updated information within the Working Forest Harvest Notice shall include disclosure of erosion sites from skid trails, skid trail crossings, or any other structures or sites that have the potential to discharge sediment attributable to Timber Operations into waters of the state resulting in significant sediment discharge and violation of water quality requirements.

(o) The type of equipment to be used for Yarding or Logging Road construction.

CALIFORNIA FOREST PRACTICE RULES

(p) Instructions on felling, Yarding, Logging Road construction or reconstructions, hauling, erosion control work, Site Preparation, erosion control maintenance, winter operations, Watercourse protection measures, Slash treatment and Logging Road maintenance.

(q) A verification that the LTO has been briefed by the RPF on the content of the Working Forest Harvest Notice and intentions of implementation to comply with the Plan.

(r) The minimum diameter of permanent culverts proposed for installation.

(s) A description of Lakes, Wet Meadows and Other Wet Areas.

(t) Description of the standard operating practice(s) to be implemented within the area covered under the Working Forest Harvest Notice.

(u) On a USGS quadrangle or equivalent map, of a scale not less than 2" to the mile, the following information pertinent to the Working Forest Harvest Notice shall be clearly provided. Additional maps may be required to show specific details, and may be planimetric. Color coding on maps may be used if they are able to be reproduced in black and white maps and clearly show all details. A legend shall be included indicating the meaning of the symbols used. See the District Rules for the appropriate minimum mapping acreages. Maps shall be updated to reflect current field conditions.

(1) Boundaries of area(s) where Timber Operations are to occur under the Working Forest Harvest Notice.

(2) Boundaries of area(s) for specified regeneration methods, intermediate treatments, special harvesting methods, and alternative prescriptions that are to be applied.

(3) Boundaries of area(s) for specified Yarding (logging) systems, if more than one (1) system is to be used.

(4) Location of all roads to be used for, or potentially Impacted by, Timber Operations. This shall include:

(A) The classification of all roads as permanent, seasonal, temporary, or deactivated.

(B) Roads and Landings located in Watercourses, Lakes, WLPZs, and Wet Meadows and Other Wet Areas, other than at road Watercourse crossings.

(C) Roads that provide access to rock pits and water drafting sites, and the location of water drafting sites.

(D) Public roads within one-quarter (1/4) mile of the harvest area.

(E) The location of significant existing and potential erosion sites on all roads and Landings pursuant to 14 CCR § 923.1(e).

(5) Location of proposed and existing Landings outside the WLPZ that are greater than 1/4 acre in size or whose construction involves substantial excavation.

(6) Location of Logging Road failures on existing Logging Roads to be Reconstructed.

(7) Location of all new permanent constructed and Reconstructed, and temporary Logging Road Watercourse crossings, including those crossings to be abandoned or deactivated.

(8) Designate areas of low, moderate, high or extreme erosion hazard rating, if more than one (1) exists.

(9) Location of Lakes and Watercourse(s) with Class I, II, III or IV waters; and Wet Meadows and Other Wet Areas including when operations are proposed pursuant to 14 CCR § 916.3(c).

(10) Location of known unstable areas or slides.

(11) Location of unique areas.

(12) Location(s) of standard operating practice(s) to be implemented within the area covered under the Working Forest Harvest Notice.

(13) The locations of Logging Roads and Landings to be abandoned or deactivated.

(14) For all constructed and Reconstructed Logging Roads and Landings, the location of excess material disposal sites on slopes greater than 40 percent or on active unstable areas.

(15) Location of all tractor road Watercourse crossings of classified Watercourses except temporary crossings of Class III Watercourses without flowing water during Timber Operations at that crossing.

(16) Location for which heavy equipment use is proposed on unstable areas, or on areas for which tractor use is proposed beyond the limitations of the standard Forest Practice Rules.

(17) Boundaries of any areas where Tractor Operations are proposed for use on areas designated for Cable Yarding.

CALIFORNIA FOREST PRACTICE RULES

(v) The Department shall make available a copy of the California Forest Practice Rules, or portions thereof, that apply to each filed Working Forest Harvest Notice.

(w) Proprietary information shall be treated consistent with PRC § 21160 and GOV § 6254.7.

(x) A certification from the RPF that no additional listings of water bodies to Section 303(d) of the Clean Water Act (33 U.S.C. Sec. 1313(d)) list have occurred on the lands of the WFMP since approval of the WFMP.

1094.9 WFMP Professional Judgment

Where these regulations provide for the exercise of professional judgment by the RPF or the Director, if there is a disagreement and if requested by either party, they shall confer on the WFMP area during the WFMP review inspection and reach agreement, if possible, on the conditions and standards to be included in the Plan.

1094.10 Plan Submitter(s) Responsibility

The plan submitter(s), or successor in interest, shall:

(a) Ensure that a RPF conducts any activities which require a RPF.

(b) Provide the RPF preparing the Plan or deviations with complete and correct information regarding pertinent legal rights to, interests in, and responsibilities for land, timber, and access as these affect the planning and conduct of Timber Operations.

(c) File with the Director a minor deviation identifying a Designated Agent that represents the plan submitter(s) at least five (5) days prior to filing the first Working Forest Harvest Notice, unless already identified in the WFMP.

(d) File with the Director a minor deviation identifying a change in the Designated Agent:

(1) Within five (5) days if active Timber Operations are occurring.

(2) Within thirty (30) days if no active Timber Operations are occurring.

(e) Sign the WFMP certifying knowledge of the Plan contents and the requirements of this section.

(f) Within five (5) working days of change in RPF responsibilities for WFMP implementation or substitution of another RPF, file with the Director a minor deviation which states the RPF's name and registration number, address, and subsequent responsibilities for any RPF required field work, preparation of deviations, or operation supervision.

(g) Provide a copy of the approved WFMP and Working Forest Harvest Notice to the LTO.

(h) Notify the Director prior to commencement of Site Preparation operations. Receipt of a burning permit is sufficient notice.

(i) Provide the RPF preparing the Working Forest Harvest Notice and the LTO each a copy of the current WFMP and subsequent deviation(s).

(j) Provide any change(s) in LTO responsibilities to the Director in writing.

(k) Provide the RPF preparing the Working Forest Harvest Notice and LTO(s) each a copy of the current Lake or Streambed Alteration Agreement, as appropriate, pursuant to Section 1600 et seq. of the Fish and Game Code that covers activities subject to this jurisdiction of activities covered under the Working Forest Harvest Notice.

(l) The plan submitter(s), or successor(s) in interest, may delegate responsibility for 14 CCR § 1094.10(f) – (k) to the Designated Agent, with written notification to the Director.

1094.11 Registered Professional Forester Responsibility

(a) Upon submission of a WFMP, the RPF who prepares and signs a Plan is responsible for the accuracy and completeness of its contents.

(b) The RPF preparing the Plan shall:

(1) Inform the Director and landowner(s) by phone, letter, or email if he or she will be attending the review inspection; and

(2) Provide the Working Forest Landowner(s) a copy of the Board Rules in effect on the date of WFMP approval.

(c) The RPF preparing the Working Forest Harvest Notice shall list or describe in the Working Forest Harvest Notice any work which will be performed by the RPF or the RPF's Supervised Designee. This may

CALIFORNIA FOREST PRACTICE RULES

include, but is not limited to, field work in identifying Watercourse and Lake Protection Zones or Special Treatment Areas, marking trees, or other activities. The RPF is only responsible for the activities required of the RPF by the Board Rules and those activities for which he or she is employed.

(d) The RPF preparing the Working Forest Harvest Notice shall, in writing, inform the plan submitter(s) and Designated Agent of their responsibility pursuant to 14 CCR § 1094.10, for compliance with the requirements of the Act and, where applicable, Board Rules regarding Site Preparation, stocking, and maintenance of Logging Roads, Landings, and erosion control facilities.

(e) The RPF who prepares the WFMP or prepares the Working Forest Harvest Notice, or any other RPF who is employed by the owner(s) or operator(s), shall report to the owner or operator if there are deviations from the WFMP that, in the RPF's judgment, threaten the attainment of the resources conservation standards of the WFMP.

(f) A RPF(s) retained by the plan submitter(s) to provide professional forestry advice throughout the Timber Operations shall be present, or ensure that the RPF's Supervised Designee is present, on the logging area at a sufficient frequency to know the progress of operations and advise the LTO(s) and Working Forest Landowner(s), but not less than once during the life of the operations conducted under a Working Forest Harvest Notice(s).

(g) The RPF shall without delay notify, in writing, the LTO(s), the plan submitter(s), the Designated Agent, and the Department of a decision to withdraw professional services from the Plan.

(h) All disclosures made between a RPF and an affected party pursuant to this section may be kept confidential.

1094.12 Interaction Between RPF and LTO on Working Forest Harvest Notice

(a) From the start of the Working Forest Harvest Notice preparation, but before commencement of operations, the responsible RPF, or Supervised Designee, shall meet with either the LTO or person who is identified in the Working Forest Harvest Notice who will be on the ground and directly responsible for the harvesting operation. The meeting shall be on site if requested by either the RPF or LTO. If any deviation is incorporated into the Working Forest Harvest Notice by a RPF after the first meeting, that RPF or Supervised Designee shall comply with the intent of this section by explaining relevant changes to the LTO; if requested by either the RPF or LTO, another on-site meeting shall take place. Written documentation of LTO/RPF meetings required under this provision shall be submitted to the Department. The intent of any such meeting is to assure that the LTO:

(1) Is advised of any sensitive on-site conditions requiring special care during operations.

(2) Is advised regarding the intent and applicable provisions of the approved Working Forest Harvest Notice including deviations.

1094.13 Licensed Timber Operator Responsibilities

Each Licensed Timber Operator shall:

(a) Inform the responsible RPF and plan submitter(s), either in writing or orally, of any site conditions which in the LTO's opinion prevent implementation of the Working Forest Harvest Notice.

(b) Keep a copy of the applicable approved Working Forest Harvest Notice and deviations available for reference at the site of active Timber Operations.

(c) Comply with all provisions of the Act, Board Rules, the applicable Working Forest Harvest Notice and any approved deviations.

1094.14 Notification of Commencement of Operations

For each Working Forest Harvest Notice submitted, within fifteen (15) days before, and not later than the day of the start of Timber Operations, the Designated Agent shall notify the Department of the start of Timber Operations. The notification, by telephone, mail, or email, shall be directed to the appropriate CAL FIRE Unit Headquarters, Forest Practice Inspector, or other designated personnel.

1094.15 Notice of WFMP Filing

(a) The Director shall prepare a Notice of Filing which shall contain the basic information contained in the Notice of Preparation to Harvest Timber pursuant to 14 CCR § 1094.3, plus the assigned WFMP number.

CALIFORNIA FOREST PRACTICE RULES

(b) Within two (2) working days of the date the Plan is filed, the Director shall transmit copies of the Notice of Filing to:

- (1) The person submitting the Plan.
 - (2) The office of the County Clerk of the county(s) in which the operations are proposed. The Notice of Filing shall be posted at the normal place for posting environmental notices.
 - (3) The local CAL FIRE Unit headquarters for posting.
 - (4) At such other locations as the Director may deem desirable and feasible to provide adequate public notice.
 - (5) All public agencies having custodial responsibility for lands within 300 ft. of the WFMP boundary.
 - (6) The Department's Internet Web site.
 - (7) To any person who requests notifications in writing.
- (c) Notice of Filing may be transmitted through internet based email.

1094.16 Agency and Public Review for the WFMP

(a) Upon receipt of the proposed WFMP, the Department shall place the proposed Plan, or a true copy of the proposed Plan, in a location available for public inspection in the county in which Timber Operations are proposed under the Plan or on the Department's Internet Web site. For the purpose of interdisciplinary review, the Department shall also transmit a copy to the Department of Conservation, the Department of Fish and Wildlife, the appropriate California Regional Water Quality Control Board, the county planning agency, and all other agencies having jurisdiction by law over natural resources affected by the Plan. The Department shall invite, consider, and respond in writing to comments received from public agencies to which the Plan has been transmitted and shall consult with those agencies at their request.

(b) The Director shall also transmit a copy of any specific Plan to any person who has made a written request therefore.

(c) The Department shall bill such persons for the cost of providing such copies and such monies shall be paid to the Department.

(d) The Director shall take the following steps when Significant New Information, as defined in 14 CCR § 895.1, is added to the Plan during the course of Plan review or during the Director's determination period.

(1) When Significant New Information are limited to a few sections or portions of the Plan, the Department need only recirculate the sections or portions that have been modified.

(2) When Significant New Information are not limited to a few sections of the Plan, the Department shall recirculate the entire Plan.

(3) The Department shall prepare a Letter of Recirculation which shall include:

(A) A brief description of the proposed project and its location. Such information shall include:

1. The Plan number and county(s).
2. The names of the Timberland Owner(s) and the plan submitter(s).
3. The location of the Plan area by county, section, township, and range.
4. The name of the nearest major Watercourse or CALWATER v2.2 ID.
5. The acres proposed to be harvested.
6. The silvicultural systems to be used.

(B) A summary of changes made to the Plan and a brief description of significant new information contained in the Plan.

(C) Clarification as to whether the entire Plan, or only those recirculated portions of the Plan, are open for public comment.

(D) The starting and ending dates for the review period during which public comments will be received. The public comment period shall be a minimum of thirty (30) days.

(E) The date, time, and place of any scheduled public meetings when known by the lead agency at the time of notice.

(F) The address where copies of the Plan record are available for public review.

(4) The Letter of Recirculation shall be sent to: all review team members; any agency, person, or organization that commented on the Plan; and all landowners who received a Notice of Preparation to

CALIFORNIA FOREST PRACTICE RULES

Harvest Timber.

(5) The Department need only respond to:

(A) Comments received during the initial circulation period that relate to sections or portions of the Plan that were not revised and recirculated, and

(B) Comments received during the recirculation period that relate to the sections or portions of the Plan that were revised and recirculated.

(6) The Department shall prepare and distribute a Notice of Recirculation equivalent to a Notice of Filing as described in 14 CCR § 1094.15.

1094.17 Director's Determination

(a) The Department shall provide a minimum time period for public comment, starting from the date of the receipt of a WFMP, as follows:

(1) Ninety (90) days for a WFMP for less than 5,000 acres.

(2) One hundred ten (110) days for a WFMP between 5,000 and 10,000 acres.

(b) Before a WFMP may be approved, all of the following requirements shall be met:

(1) Within thirty (30) working days of the receipt of a WFMP, or within forty (40) working days of the receipt of a Plan to which a Road Management Plan pursuant to 14 CCR § 1093 is appended, the Department shall determine if the Plan is accurate, complete, and in proper order, and if so, the Plan shall be filed. An unfiled Plan shall be returned to the plan submitter(s) with an explanation that includes provisions for resubmitting the Plan.

(2) The initial inspection shall be initiated within twenty (20) working days from the date of filing of the WFMP, and completed no more than thirty (30) working days from the date of filing.

(3) Upon completion of the initial inspection, the Department shall have up to forty five (45) working days to conduct the final interagency review of the Plan.

(4) The public comment period shall end twenty (20) working days after the completion of the final interagency review of the Plan or until the requirement in subsection (a) is met, whichever is greater.

(5) After the final interagency review and public comment period has ended, the Department shall have up to thirty (30) working days to review the public input, to consider recommendations and mitigation measures of other agencies, to respond in writing to the issues raised, and to determine if the Plan is in conformance with the applicable Board Rules and other applicable provisions of law.

(c) If after final interagency review the Director determines that the Plan is not in conformance with the Board Rules or the FPA, the Director shall deny and return the Plan, stating the reasons for the denial and advising the plan submitter of the person's right to a hearing before the Board pursuant to 14 CCR § 1054.

(d) If the Director does not act within the time periods provided in 14 CCR § 1094.17(b), the Director and the Timberland Owner(s) submitting the WFMP shall negotiate and mutually agree upon a longer period for the Director to review the Plan. If a longer period cannot be mutually agreed upon, the WFMP shall be deemed denied and returned to the Timberland Owner(s) submitting the Plan.

(e) The following provisions apply to the appeal of a denied WFMP:

(1) A Timberland Owner(s) whose Plan is denied pursuant to 14 CCR §§ 1094.17(c) or 1094.17(d) may request, within thirty (30) working days from the receipt of the Plan, a public hearing before the Board. The Board shall schedule a public hearing to review the Plan to determine if the Plan is in conformance with the Board Rules and the FPA.

(2) Board action shall take place within thirty (30) working days from the filing of the appeal, or a longer period mutually agreed upon by the Board and the person filing the appeal.

(3) If the Director's decision to deny the Plan is overturned by the Board, the Board shall prepare findings and its rationale for overturning the decision, and return the Plan to the Department for approval by the Director.

(4) If the Plan is not approved on appeal to the Board, the Director, within ten (10) working days of Board action, shall advise the plan submitter(s) regarding changes needed that would achieve compliance with the FPA and other applicable provisions of the law. The Plan submitter(s) shall have forty five (45) working days from the date of the notification letter, or longer if mutually agreeable to the Department and the plan submitter(s), to revise the Plan to bring it into full conformance with the Board Rules and the FPA. Upon receipt of the information requested of the plan submitter(s), the Department shall recirculate the Plan

CALIFORNIA FOREST PRACTICE RULES

and reopen the public comment period for thirty (30) working days. Prior to determining whether to approve the proposed revised Plan, the Director shall have thirty (30) working days to review public input and consider recommendations and mitigation measures of other agencies, and to respond in writing to issues raised.

1094.18 Review Teams to be Established to Review WFMP

Interdisciplinary review teams shall be established by the Director to review plans and assist the Director in the evaluation of proposed WFMP(s) and its Impacts on the environment. The Review Team composition, function, tasks and procedures shall be the same as those described in 14 CCR § 1037.5.

1094.19 Nonconformance of WFMP

If the Director determines that a Plan is not in conformance with the Board Rules, the Plan shall be returned in accordance with 14 CCR § 1054. In addition, the Director shall state any changes and reasonable conditions that in the Director's professional judgment are needed to bring the Plan into conformance with the applicable Board Rules and offer to confer with the RPF in order to reach agreement on the conditions necessary to bring the Plan into conformance.

1094.20 Conformance of WFMP

If the Director determines that the Plan is in conformance with Board Rules, then the person submitting the Plan shall be notified Timber Operations thereunder may only commence after submission of a Working Forest Harvest Notice as prescribed in 14 CCR § 1094.7.

1094.21 Notice of Conformance of the WFMP

Within ten (10) working days of the date a Plan is found in conformance, the Director shall transmit a notice thereof to the agencies and persons referred to in 14 CCR § 1094.16 and for posting at the places named in 14 CCR § 1094.15. A copy of the notice shall be filed with the Secretary of the Natural Resources Agency. The Notice of Conformance shall include a written response of the Director to significant environmental points raised during the evaluation process.

1094.22 Public Inspection

Notices of Conformance, pursuant to 14 CCR § 1094.21 and notices of nonconformance, pursuant to 14 CCR § 1054, shall be available for public inspection, and a list of such notices shall be posted on a weekly basis in the Office of the Natural Resources Agency. Each such list shall remain posted for a period of thirty (30) days.

1094.23 Substantial Deviations

(a) The Designated Agent may submit a proposed deviation, as prepared by the RPF, to the approved Plan. No action shall occur that substantially deviates, as defined by the Board, from the approved Plan until the substantial deviation has been approved by the Director. The Director shall determine, after completion of the interagency review and public comment period, either of the following:

(1) The substantial deviation is in compliance with the current Board Rules and provisions in the FPA.

(2) The substantial deviation is in compliance with the Board Rules and provisions in the FPA that were in effect at the time the WFMP was approved. The Director may only make this determination if a RPF explains, justifies, and certifies both of the following:

(A) The adherence to new or modified Board Rules would cause unreasonable additional expense, pursuant to PRC § 4583, to the Working Forest Landowner(s).

(B) Compliance with the Board Rules and provisions in the FPA that were in effect at the time the WFMP was approved will not result in any significant degradation to the beneficial uses of water, soil stability, forest productivity, or wildlife.

(b) Review timelines for substantial deviations of WFMPs shall conform to the direction provided in PRC § 4582.7, except for substantial deviations that add acreage covered by the original WFMP that exceeds ten (10) percent or five hundred (500) acres, whichever is greater. Substantial deviations that add acreage in

CALIFORNIA FOREST PRACTICE RULES

excess of ten (10) percent or five hundred (500) acres shall be reviewed pursuant to the procedures specified in PRC § 4597.6.

(c) Changes are presumed to be substantial deviations if they could have a significant effect on the conduct of Timber Operations and potentially could have a significant adverse effect on timber productivity or values relating to soil, water quality, watershed, wildlife, fisheries, range and forage, recreation, and aesthetic enjoyment. Such actions may include, but are not limited to:

- (1) Change in location of timber harvesting operations within the WFMP area.
- (2) Enlargement of the WFMP area.
- (3) An increase in volume to be harvested exceeding ten (10) percent as projected by the LTSY.
- (4) Change in the silvicultural method and cutting system on any portion of the Plan area.
- (5) Change in type or location of logging (Yarding) system or basic type of equipment.
- (6) Change in location, nature or increase in length of proposed Logging Roads incorporating one or more of the following criteria:
 - (A) Any Logging Road in a Watercourse or Lake Protection Zone or where sidecast will extend into the Watercourse or Lake Protection Zone.
 - (B) Any Logging Road located in an extreme Erosion Hazard Rating area.
 - (C) Any Logging Road where the average side slope exceeds fifty (50)%.
 - (D) Any Logging Road where unstable areas, active soil movement, or slide areas must be traversed.
 - (E) Any increase in gradient allowed by the District Rules as an exception and not provided for in the original Plan.
- (7) Any road extension of more than six hundred (600) ft. (182.9m).
- (8) Any use of existing roads not shown in the original Plan when reconstruction work to allow for vehicle travel will be substantial. Substantial work on an existing road means more than minor repair and dressing of the travel surface and removal of vegetation to allow for vehicle passage.
- (9) Use of any Logging Roads not shown in the Plan which would affect the key habitat, not previously discussed in the Plan, of: state or federally listed threatened, candidate, and endangered species; rare plants; Sensitive Species pursuant to 14 CCR § 895.1; and species that meet the criteria under 14 CCR § 15380(d).
- (10) Enlargement of Landings where such enlargement was not justified in the Plan.
- (11) Any change of operation within, or designation of, Watercourse or Lake Protection Zones.
- (12) Any downgrading of Watercourse classification.
- (13) A change to winter operations where summer operations were previously specified.

1094.24 Report of Minor Deviations

(a) "Minor deviations" means any change, minor in scope, in a Plan which can reasonably be presumed not to make a significant change in the conduct of Timber Operations and which can reasonably be expected not to significantly adversely affect Timberland productivity or values relating to soil, water quality, watershed, wildlife, fisheries, range and forage, recreation, and aesthetic enjoyment or to result in a violation of the applicable water quality control plan.

(b) Minor deviations may be undertaken by the person who submitted the WFMP or Working Forest Harvest Notice without submission of a minor deviation to the Plan and shall be reported immediately in writing to the Director. Actions described in 14 CCR § 1094.23 which are normally presumed to be substantial deviations may, in a given instance, be a minor deviation. Actions listed as substantial deviations in 14 CCR § 1094.23, but considered to be minor deviation by the submitter(s), may be undertaken only if the person who submitted the Plan or the Designated Agent submits the proposed deviation in writing to the Director for review and receives approval. Approval shall be given if the Director determines that the proposed minor deviation conforms to the standards provided in 14 CCR § 1094.24(a). The Director shall have five (5) working days to act on the application. If the Director or the representative of the Director does not act within five (5) working days of receipt of such a deviation, Timber Operations may commence pursuant to such minor deviation.

(c) Newly adopted Board Rules may be incorporated into an approved WFMP through a minor deviation.

CALIFORNIA FOREST PRACTICE RULES

1094.25 Report of Completion of Work Described in WFMP; Partial Completion Report

(a) Within one (1) month after completion of the work described in the Working Forest Harvest Notice, excluding work for stocking, Site Preparation, or maintenance of drainage facilities and soil stabilization treatments on skid trails, roads, and Landings after the Plan period, a report shall be filed by the Timber Owner(s) or the Designated Agent with the Department that all work, except stocking, Site Preparation, or maintenance of drainage facilities and soil stabilization treatments, has been completed.

(b) If all of the work described in the Plan has not been completed, a report may be filed annually with respect to a portion of the area covered by the Plan which has been completed. The portion completed shall be adequately identified on a map submitted with the report.

(c) The report filed by the Timber Owner(s) or the Designated Agent shall also include:

- (1) The acres harvested.
- (2) A map of the operating area.
- (3) The volume harvested in relation to the projections in the WFMP.
- (4) Proprietary information shall be treated consistent with PRC § 21160 and GOV § 6254.7.

1094.26 Inspection of Completed Work

Within six (6) months of the receipt of the work completion report specified in 14 CCR § 1094.25, the Director shall determine, by inspection, whether the work described in the report has been properly completed in conformity with the Board Rules and the provisions in the FPA. If the work has been so completed, the Director shall issue a report of satisfactory completion of the work. If not, the Director shall take such corrective action as the Director determines to be appropriate in accordance with Article 8 of Chapter 8 of Part 2 of Division 4 of the Public Resources Code (commencing with PRC § 4601).

1094.27 Stocking Report and Minimum Stocking Standards

(a) Within five (5) years after the completion of Timber Operations or as otherwise specified in the regulations, a report of stocking on the entire area logged under a Working Forest Harvest Notice and shown on a revised map shall be filed with the Director by the Timber Owner(s) or the Designated Agent. If stocking is required to be met upon completion of Timber Operations the stocking report shall be submitted within six (6) months of the completion of operations. The minimum acceptable stocking standards on logged areas which were acceptably stocked prior to harvest are those specified in the Coast, Northern, and Southern Forest District Rules. If not otherwise specified, the following minimum standards apply:

(1) On Site I Timberlands as defined by the Board, the average residual basal area, measured in stems one inch or larger in diameter shall be at least 85 square feet per acre; or on Site II or lower shall be at least 50 sq. ft. per acre; or

(2) The area contains an average point count of 300 per acre on Site I, II, and III lands or 150 on Site IV and V lands as specified in PRC § 4561. See 14 CCR §§ 912.7, 932.7 and 952.7 for information for the point count values of various size trees and for determining how sprouts will be counted toward meeting stocking requirements.

1094.28 Inspection of Stocking

Within six (6) months of the receipt of the stocking report, the Director shall determine, by inspection, whether the stocking has been properly completed. If so, the Director shall issue a report of satisfactory completion of stocking. If not, the Director shall take such corrective action as the Director deems appropriate in accordance with the provisions of Article 8 of Chapter 8 of Part 2 of Division 4 of the Public Resources Code (commencing with PRC § 4601).

1094.29 Five (5) Year Review of WFMP

(a) The Department shall publish a public notice that the five (5) year review of the WFMP shall commence at least thirty (30) days prior to each five (5) year anniversary date of the WFMP approval. The published notice shall contain a copy of the plan summary and shall indicate that public comment on the five (5) year review shall be accepted during the thirty (30) day period. The public may submit to the review team additional information relevant to the purpose of the five (5) year review and the review team may consider this information when conducting its review. The Director shall distribute copies of the five (5) year review

CALIFORNIA FOREST PRACTICE RULES

public notice and plan summary to:

- (1) The Office of the County Clerk of the county(s) in which the approved WFMP resides;
- (2) The local CAL FIRE Unit headquarters for posting;
- (3) At such other locations as the Director may deem desirable and feasible to provide adequate

public notice;

- (4) The Department's Internet Web site.
- (5) Working Forest Landowner(s) and the Designated Agent if one exists.

(b) The Director shall convene a meeting with the interdisciplinary review team, pursuant to 14 CCR § 1037.5, within thirty (30) days following each five (5) year anniversary of a WFMP approval to review the Plan's administrative record, agency comment, public comment, plan summary, and any other relevant information to verify that completed or current timber operation(s) have been conducted in accordance with the Plan and applicable laws and regulations. Additionally, the review team shall also analyze any significant episodic events occurring during the previous five (5) years including disease and drought caused tree mortality, windthrow, wildfire and landslides. Participation by review team agencies shall be at the discretion of each agency. If at this meeting a member of the review team determines that a field inspection is necessary to verify that Timber Operations have been conducted in accordance with the Plan and applicable laws and regulations, then a field inspection may be conducted within sixty (60) days following each five (5) year anniversary date of WFMP approval.

(c) The plan summary shall include number of Working Forest Harvest Notices, acreage operated under each Working Forest Harvest Notice, the number of violations received, the number of substantial deviations received, and the volume harvested in relation to projections of harvest in the WFMP to determine if Timber Operations under Working Forest Harvest Notice(s) were conducted in compliance with the content and procedures in the WFMP.

(d) If the Department or a review team agency does not have direct access to information needed for the five (5) year summary, the Department may require the Working Forest Landowner(s) to provide this information.

(e) If notices of violation have been issued, or the five (5) year review indicates potentially significant adverse Impacts to the environment may occur from continuance of the WFMP, or if the Department is presented with a fair argument that a project may have a significant adverse Impact on the environment, the Department shall provide written comments to the Designated Agent that a review of the WFMP content and procedures may be necessary. The Director shall state any changes and reasonable conditions in the Director's professional judgment that are needed to bring Timber Operations into compliance with the applicable Board Rules and offer to confer with the Designated Agent in order to reach agreement on the conditions necessary to bring the Timber Operations into compliance and to mitigate significant adverse Impacts on the environment identified during the five (5) year review. Failure to implement the changes or reasonable conditions provided by the Director or developed in conference with the Designated Agent may result in cancellation of the WFMP pursuant to 14 CCR § 1094.31(b).

(f) The findings of the five (5) year review shall be completed by the Department within sixty (60) days of each five (5) year anniversary date of the WFMP approval, or within one hundred and five (105) days of each five (5) year anniversary date of the WFMP approval if a field inspection is completed.

(g) The findings of the five (5) year review shall be distributed on the Department's Internet Web site and the Department shall notify the Working Forest Landowner(s) of the findings of the five (5) year review.

(h) This section does not authorize the public disclosure of proprietary information without first obtaining the Working Forest Landowner's consent. Proprietary information shall be treated consistent with PRC § 21160 and GOV § 6254.7.

1094.30 Change of Timberland Owner(s)

(a) Upon a change of ownership of the land described in the WFMP, the transferring Timberland Owner(s) shall provide the acquiring Timberland Owner(s) with a written Transfer of Responsibilities Notice that discloses the existence of the WFMP and informs the acquiring Timberland Owner(s) of the need to notify the Department of the acquiring Timberland Owner(s) intent to assume the responsibilities of the WFMP. The transferring Timberland Owner(s) shall also send the Department a copy of the Transfer of Responsibilities Notice provided to the acquiring Timberland Owner(s).

CALIFORNIA FOREST PRACTICE RULES

(b) If the transferring Timberland Owner(s) fails to provide the Notice required in the 14 CCR § 1094.30(a) and the Department discovers the change of ownership, the Department shall provide the acquiring Timberland Owner(s) with the Transfer of Responsibilities Notice.

(c) The acquiring Timberland Owner(s) shall have one (1) year from the date of receipt of the Transfer of Responsibilities Notice pursuant to either 14 CCR § 1094.30(a) or 14 CCR § 1094.30(b), whichever is applicable, to notify the Department in writing of their intent to assume the responsibilities of the WFMP. If the Department does not receive notification within this period, the Department may cancel the WFMP.

(d) Upon transfer of ownership, the Timberland Owner(s) shall identify a Designated Agent pursuant to 14 CCR § 1094.10.

(e) A violation of this section by a Timberland Owner(s) does not constitute a crime pursuant to PRC § 4601.

(f) After a Plan is found in conformance with the Board Rules, the Director may file a Notice of Stocking Requirements on the property with the recorder of the county within which the Plan is located if any area logged under a Working Forest Harvest Notice has not had a report of satisfactory stocking issued by the Director.

1094.31 Cancellation of Plans

(a) The Working forest landowner(s) may cancel the WFMP by submitting a written notice to the Department. Once Timber Operations have commenced pursuant to a Working Forest Harvest Notice, cancellation is not effective on land covered by the Working Forest Harvest Notice until a report of satisfactory completion has been issued pursuant to PRC §§ 4585, 4586 and 4587.

(b) If the Department determines that the objectives of Uneven aged Management and Sustained Yield are not being met by a Working Forest Landowner(s), or there are other persistent violations detected that are not being corrected, the Department shall cancel a previously approved WFMP and any further Timber Operations under the Plan shall be terminated. In making a determination to cancel a Plan, the Department may cite the findings of a review conducted pursuant to PRC § 4597.12 and 14 CCR § 1094.29. Cancellation of the Plan may be appealed by the plan submitter(s) or the Designated Agent utilizing the process pursuant to PRC § 4597.6(e)(1) and 14 CCR § 1094.17(e).

1094.32 Transition or Expansion of Plans

(a) If a landowner with an approved NTMP with less than 2,500 acres of Timberland expands the total Timberland ownership to 2,500 or more acres of Timberland through acquisition of additional Timberland they may transition into a WFMP through a substantial deviation to the NTMP.

(1) Operations may continue under an approved NTMP for a period of one (1) year after the acquisition of property that would result in 2,500 or more acres of Timberland, if the landowner notifies the Director in writing of their intent to transition to a WFMP. The Director may grant up to an additional one (1) year of operations under the previously approved NTMP to landowners who demonstrate substantial work has been conducted by a RPF(s) towards transitioning to a WFMP. Substantial work may include, but is not limited to, augmented growth and yield, harvest document preparation, legal document preparation, updated field work or biological assessments.

(2) The lack of demonstration of substantial work being conducted by a RPF toward transitioning to a WFMP shall result in cancellation of the NTMP by the Department.

(3) The RPF responsible for preparation of the substantial deviation to transition an approved NTMP to a WFMP shall review the contents of this article including, but not limited to, 14 CCR §§ 1094.1 – 1094.3, 1094.6, 1094.10 - 1094.12, 1094.23, 1094.24 and 1094.32 to assure that all required information is included and addressed in the proposed substantial deviation prior to submittal to the Director.

(b) A Working Forest Landowner with an existing WFMP may expand the acreage of the WFMP pursuant to the process described in 14 CCR § 1094.23.

1094.33 Safe Harbor Agreement

A participating landowner(s), in conjunction with the preparation of an application for a WFMP filed with

CALIFORNIA FOREST PRACTICE RULES

the Department, may also seek approval of a Safe Harbor Agreement from the Department of Fish and Wildlife, pursuant to Article 3.7 (commencing with Section 2089.2) of Chapter 1.5 of Division 3 of the Fish and Game Code. All review costs associated with the Safe Harbor Agreement approval process incurred by the Department of Fish and Wildlife pursuant to this section shall be paid from the fund created in PRC § 4629.3.

1094.34 State Restoration Projects

Notwithstanding any other law, if a person with a WFMP applies for state restoration grant funding for a restoration project that provides a significant public benefit, the application shall not be summarily denied on the basis that the project is a required condition of the Plan.

1094.35 Southern Subdistrict

This WFMP shall not apply to the Southern Subdistrict of the Coast Forest District, as defined in Section 14 CCR § 895.1.

Article 7 Conversion of Timberland

1100 Definitions

The following are definitions of words and terms as used in this article:

(a) "Alternate Use or Alternative Use" means a proposed land use that is not a Compatible Use within a Timberland production zone (Reference: § 51134(b), Government Code).

(b) "Bona Fide Intention or bona fide intent" means a present, sincere intention of the applicant to conform with and successfully execute the conversion Plan, as determined by the Director in accordance with provisions of § 1105.2 (Reference: § 4623, Public Resource Code.)

(c) "Coastal Commercial Timberlands" means Timberland as defined in PRC § 4526, for those lands which lie within the Coastal Zone and outside a Timberland production zone. (Reference: §§ 4526 and 30243, Public Resource Code.)

(d) "Coastal Zone" means those lands defined in PRC § 30103. (Reference: § 30103, Public Resource Code.)

(e) "Compatible Use" means Compatible Use as defined in Gov. C. § 51104(h) and 51201(e), as made specific by county or city ordinance adopted pursuant thereto. (Reference §§ 51104(h) and 51201(e), Government Code.)

(f) "Contiguous" means two or more parcels of land that are adjoining or neighboring or are sufficiently near to each other, as determined by the County Board of Supervisors or City Council, that they are manageable as a single forest unit. (Reference § 51104(b), Government Code.)

(g) "Timberland Conversion" means:

(1) Within non-TPZ Timberland, transforming Timberland to a non-timber growing use through Timber Operations where:

(A) Future timber harvests will be prevented or infeasible because of land occupancy and activities thereon; or

(B) Stocking requirements of the applicable district forest practice Rules will not be met within five years after completion of Timber Operations; or

(C) There is a clear intent to divide Timberland into ownerships of less than three acres (1.214 ha.).

(2) Within TPZ lands, the immediate rezoning of TPZ lands, whether Timber Operations are involved or not except as exempt from a Timberland Conversion Permit under 14 CCR § 1104.1.

(h) "Conversion Permit" means the Timberland Conversion Permit, issued by the Director or the Board upon appeal, approving the application for Timberland conversion and authorizing a conversion of Timberland to use or uses other than the growing of timber (Reference: §§ 4622, 4624, 4624.5 and 4625, Public Resource Code.)

(i) "Government Agency" means the State or any department, agency, or public body thereof, a city or county, public corporation, municipal corporation, or public district. ((Reference: §§ 21062 and 21063, Public Resource Code.)

CALIFORNIA FOREST PRACTICE RULES

(j) "Immediate Rezoning" means a change in zoning for land use by the appropriate county or city having jurisdiction of an area within a TPZ to allow an alternative use pursuant to Article 4 (commencing with § 51130) of Chapter 6.7, Part 1, Division 1, Title 5 of the Government Code. (Reference: § 4526, Public Resource Code; § 51130, Government Code.)

(k) "Land Parcel" means a piece of land under one ownership where no part is completely separated from any other part by a different fee ownership.

(l) "Parcel" means parcel as defined in Sec. 51104(i) of the Government Code.

(m) "Timberland" means Timberland as defined in PRC § 4526, for land outside a Timber production zone. "Timberland" means Timberland as defined in Gov. C. § 51104(f) for land within a Timberland production zone (Reference: § 4526, Public Resource Code; § 51104(f) Government Code.)

(n) "Timberland Production Zone" or "TPZ" means Timberland production zone as defined in Gov. C. § 51104(g) (Reference: § 51104(g), Government Code.)

1101 Purpose

The purpose of these regulations is to interpret and make specific certain provisions of the Z'berg-Nejedly Forest Practice Act of 1973, contained in Chapter 8 (commencing with Section 4511) of Part 2, Division 4 of the PRC; the Environmental Quality Act of 1970, contained in Division 13 (commencing with Section 21000) of the PRC; portions of the Z'berg-Warren-Keene-Collier Forest Taxation Reform Act of 1976 (Chapter 176, California Statutes of 1976), contained in Chapter 67 (commencing with Section 51100) or Part 1, Division 1, Title 5 of the Gov. C.; the California Coastal Act of 1976, contained in Division 20 (commencing with Sec. 30000) of the PRC; and the Public Records Act contained in Chapter 3.5 (commencing with Sec. 6250) of Division 7, Title 1 of the Government Code. These regulations pertain to the conversion of certain timber-growing lands to a use or uses other than the growing of timber.

1102 Authority Delegated to Director

The Board delegates its authority and responsibilities to the Director for administration of Article 9 (commencing with Sec. 4621) of Chapter 8, Part 2, Division 4 of the PRC, and Article 4 (commencing with Sec. 51130) of Chapter 6.7, Part 1, Division 1, Title 5 of the Gov. C., and the administrative regulations adopted pursuant to each of the above cited authorities, except that all hearings thereunder shall be before the Board.

1103 Conversion of Timberland

Any person, firm, corporation, company, partnership or government agency owning Timberland for which the Timberland Owner proposes conversion as defined in Section 1102 shall apply to the Director on a form prescribed by him for issuance of a Timberland Conversion Permit.

1103.1 Prohibited Activity

(a) No Timber Operations or other conversion activities shall be conducted on Timberland which is proposed to be converted to a use other than the growing of timber unless a Conversion Permit has been issued by the Director or the Board upon appeal and the permit has been recorded in compliance with 14 CCR [1106.3](a).

(b) No Timber Operations shall be conducted on Timberland for which a Conversion Permit has been issued until a Timber Harvesting Plan has been filed with and found in conformance by, the Director in accordance with Article 7 (commencing with Sec. 4581) of Chapter 8, Part 2, Division 4 of the PRC and the Rules and regulations of the Board issued pursuant thereto.

(c) The Timberland Owner shall provide each Timber Operator copies of both the recorded Conversion Permit, and recorded amendments thereto, and the approved THP. Copies of said documents shall be conveniently available for inspection at all times during Timber Operations conducted pursuant to said Conversion Permit.

1103.2 Public Records

All applications, forms, documents, correspondence, maps, photographs, and other materials submitted to the Director or Board relating to an application for conversion are public records pursuant to the provisions

CALIFORNIA FOREST PRACTICE RULES

of the Public Records Act, contained in Chapter 3.5 (concerning with Sec. 6250) of Division 7, Title 1 of the Gov. C.

1104 Operations Requiring Conversion Permit

Except as exempted by Sec. 1104.1 and 1104.2 of this article a Timberland Conversion Permit issued by the Director is required for conversion of Timberland as defined in Sec. 1100. Issuance of the Timberland Conversion Permit to the Timberland Owner must be completed before conversion operations begin. "Conversion operations" include final immediate rezoning of Timberland production zone lands, and Timber Operations as defined in PRC 4527 on non-Timberland production zone Timberlands.

1104.1 Conversion Exemptions

Timber Operations conducted under this subsection shall be exempt from Conversion Permit and timber harvesting plan requirements of this article except no tree that existed before 1800 A.D and is greater than sixty (60) inches in diameter at stump height for Sierra or Coastal Redwoods, and forty-eight (48) inches in diameter at stump height for all other tree species shall be harvested unless done so under the conditions or criteria set forth in subsection 1104.1 (i).

Timber Operations shall comply with all other applicable provisions of the Z'berg-Nejedly Forest Practice Act, regulations of the Board and currently effective provisions of county general plans, zoning ordinances and any implementing ordinances. The Notice of Conversion Exemption Timber Operations shall be considered synonymous with the term "plan" as defined in 14 CCR 895.1 when applying the operational Rules and regulations of the Board.

(a) This conversion exemption is applicable to a conversion of Timberland to a non-timber use only, of less than three acres in one contiguous ownership, whether or not it is a portion of a larger land parcel and shall not be part of a THP. This conversion exemption may only be used once per contiguous land ownership. If all or a portion of the contiguous land ownership has been subject to prior, unpermitted Timberland conversion, a conversion exemption hereunder shall not be accepted unless the Director determines that it would be consistent with the purposes of the Act. No person, whether acting as an individual, acting as a member of a partnership, or acting as an officer or employee of a corporation or other legal entity, may obtain more than one exemption pursuant to this section in a five-year period. If a partnership has as a member, or if a corporation or any other legal entity has as an officer or employee, a person who has received this exemption within the past five years, whether as an individual or as a member of a partnership, or as an officer or employee of a corporation or other legal entity, then that partnership, corporation, or other legal entity is not eligible for this exemption. "Person," for purposes of this section, means an individual, partnership, corporation, or any other legal entity.

(1) A Notice of Conversion Exemption Timber Operations (notice) must be prepared by an RPF and submitted to the Director. The notice shall contain the following:

(A) The names, addresses, and telephone numbers of the Timber Owner, owner of the Timberland to be converted, RPF, Timber Operator, and the submitter of the Notice of Conversion Exemption Timber Operations;

(B) Legal description of the area where the timber operation is to be conducted, showing section, township, range, county and assessor parcel number;

(C) Maps showing the ownership boundaries, the location of the timber operation, boundaries of the conversion, access routes to operation, location and classification of all Watercourses, and Landing locations;

(D) Incorporation of a signed and dated statement from the authorized designee of the County Board of Supervisors stating that the conversion is in conformance with all county regulatory requirements, including county public notice requirements. When counties do not have an authorized designee, the RPF shall certify that the county has been contacted and the conversion is in conformance with county regulatory requirements (this may be incorporated into the notice);

(E) Incorporation of a statement by the owner of the Timberland to be converted:

1. certifying that this is a one-time conversion to non-Timberland use,
2. certifying that after considering the owner's own economic ability to carry out the proposed conversion and the feasibility evaluation required by 14 CCR § 1104.1(a)(6) that there is a "bona

CALIFORNIA FOREST PRACTICE RULES

fide intent", as defined in 14 CCR § 1100 (b), to convert,

3. specifying what the non-Timberland use will be after conversion, and

4. certifying and declaring under penalty of perjury that he/she whether acting as an individual, acting as a member of a partnership, or acting as an officer or employee of a corporation or other legal entity, has not obtained an exemption pursuant to this section in the last five years unless a waiver has been granted pursuant to 14 CCR § 1104.1(a)(9); and

(F) signature of the submitter, Timberland Owner responsible for the conversion, the Timber Operator, and the RPF.

(2) The following conditions apply to conversion exemption Timber Operations:

(A) All Timber Operations shall be complete within one year from the date of acceptance by the Director.

(B) All conversion activities shall be complete within two years from the date of acceptance by the Director unless under permit by local jurisdiction. Failure to timely complete the conversion shall require compliance with stocking standards of the PRC 4561 and stocking report requirements of Forest Practice Act and Board regulations.

(C) The RPF or supervised designee shall visit the site and flag the boundary of the conversion exemption timber operation and flag any applicable WLPZs and equipment limitation zones.

(D) This section refers to Slash and woody debris resulting from Timber Operations associated with conversion exemptions. The Timber Operator shall be the responsible party for the treatment of logging Slash and woody debris.

(1) Unless otherwise required, Slash greater than one inch in diameter and greater than two feet long, and woody debris, except pine, shall receive full treatment no later than April 1 of the year following its creation, or within one year from the date of acceptance of the conversion exemption by the Director, whichever comes first.

(2) All pine Slash three inches and greater in diameter and longer than four feet must receive initial treatment if it is still on the parcel, within seven (7) days of its creation.

(3) All pine woody debris longer than four feet must receive an initial treatment prior to full treatment.

(4) Initial treatment shall include limbing woody debris and cutting Slash and woody debris into lengths of less than four feet, and leaving the pieces exposed to solar radiation to aid in rapid drying.

(5) Full treatment of all pine Slash and woody debris must be completed by March 1 of the year following its creation, or within one year from the date of acceptance of the conversion exemption by the Director, whichever comes first.

(6) Full Slash and woody debris treatment may include any of the following:

a. burying;

b. chipping and spreading;

c. piling and burning; or

d. removing Slash and woody debris from the site for treatment in

compliance with (a)-(b).

Slash and woody debris may not be burned by open outdoor fires except under permit from the appropriate fire protection agency, if required, the local air pollution control district or air quality management district. The burning must occur on the property where the Slash and woody debris originated.

(7) Slash and woody debris, except for pine, which is cut up for firewood shall be cut to lengths 24 inches or less and set aside for drying by April 1 of the year following its creation. Pine Slash and woody debris which is cut up for firewood shall be cut to lengths 24 inches or less and set aside for drying within seven (7) days of its creation.

All treatment work must be completed prior to the expiration date for the conversion exemption.

(8) Any treatment which involves burning of Slash or Woody Debris shall comply with all state and local fire and air quality Rules.

(9) This section does not supersede more restrictive treatments or time frames within a Forest district or subdistrict.

(E) Timber Operations may be conducted during the Winter Period. Tractor Operations in

CALIFORNIA FOREST PRACTICE RULES

the winter period are allowed under any of the following conditions:

1. During dry, rainless periods but shall not be conducted on saturated soil conditions that may produce significant sediment discharge. Erosion control structures shall be installed on all constructed skid trails and tractor roads prior to sunset if the National Weather Service forecast is a "chance" (30% or more) of rain within the next 24 hours.

2. When ground conditions in the conversion exemption area and appurtenant roads satisfy the "hard frozen" definition in 14 CCR 895.1.

3. Over-snow operations where no soil disturbance occurs.

(F) No Timber Operations within a WLPZ unless specifically approved by local permit (e.g. County, City).

(G) The Timber Operator shall not conduct Timber Operations until receipt of the Director's notice of acceptance. Timber Operations shall not be conducted without a valid on-site copy of the Director's notice of acceptance of operations and a copy of the Notice of Conversion Exemption Timber Operations as filed with the Director.

(H) No sites of rare, threatened or endangered plants or animals shall be disturbed, threatened or damaged and no Timber Operations shall occur within the Buffer Zone of a sensitive species as defined in 14 CCR 895.1.

(I) No Timber Operations on significant historical or archeological sites, except under the following conditions:

1. If a significant archeological site is identified by the RPF preparing the Notice of Conversion Exemption within the project boundary, the site may be preserved in place by capping or covering with a layer of soil prior to submission.

a. If a site has been preserved in place, the RPF preparing the Notice of Conversion Exemption shall obtain written concurrence from a Department Archeologist prior to submission indicating operations will not cause damage to a significant archeological site.

b. The written concurrence from a Department Archeologist shall be submitted with the Notice of Conversion Exemption.

(J) The RPF and the Timber Operator shall meet (on-site, or off-site) if requested by either party to ensure that sensitive on-site conditions and the intent of the conversion regulations such as, but not limited to, Slash disposal, will be complied with during the conduct of Timber Operations.

(K) Before beginning Timber Operations, the Timber Operator shall notify the Department of the actual commencement date of operations. The notification, by telephone, mail, or email, shall be directed to the appropriate CAL FIRE Unit Headquarters, Forest Practice Inspector or other designated personnel. If the notification is provided by mail, Timber Operations may not commence until three (3) days after the postmark date of notification.

(3) A neighborhood notification of conversion exemption Timber Operations shall be posted on the ownership visible to the public by the RPF or supervised designee, at least five (5) days prior to the postmark date of submission of the notice of Conversion Exemption Timber Operations to the Director. The date of posting shall be shown on the neighborhood notice. In addition, immediately prior to the submission of the exemption to the Director, the landowner shall mail a letter to adjacent landowners within 300 feet of the boundaries of the exemption, and to Native Americans, as defined in 895.1 notifying them of the intent to harvest timber. The mailed letter of notice and the posted notice shall contain a map of the project area and the following information on a form prepared by the RPF:

(A) the name, address and telephone number of the Timberland Owner, the Timber Operator, the agency of the county responsible for land use changes and the designated representative; if any, and the RPF;

(B) the location of the project, parcel number, street address, section, township and range, and;

(C) a statement explaining that this is a conversion from Timberland use to a new land use, what the new land use will be, and that the maximum size is less than three acres.

(4) The Director shall determine if the Notice of Conversion Exemption Timber Operations is complete and accurate within fifteen (15) days from the date of receipt.

(A) If the Notice of Conversion Exemption Timber Operations is not complete and accurate

CALIFORNIA FOREST PRACTICE RULES

it shall be returned to the submitter identifying the specific information required. When found complete and accurate, the Director shall immediately send a notice of acceptance of operations to the submitter.

(5) The Timberland Owner shall, within one month from the completion of conversion exemption Timber Operations, which includes all Slash disposal work, submit a work completion report to the Director.

(6) The Timberland Owner shall, using the services of an RPF to the extent the information required is within the scope of professional forestry practice, provide information documenting that the conversion to the stated non-timber use is feasible based upon, at a minimum, the following:

(A) the extent of the vegetation removal and Site Preparation required for the conversion;

(B) the suitability of soils, slope, aspect, and microclimate for the stated non-timber use;

(7) The Department shall provide for inspections, as needed, to determine that the conversion was completed.

(8) The notice shall expire if there is any change in Timberland ownership.

(A) If the conversion has not been completed, the Timberland Owner on the notice shall notify the Department of the change in Timberland ownership on or before five (5) days after a change in ownership.

(B) If operations have been conducted, but not completed under the exemption, the Timberland Owner on the notice shall notify the new Timberland Owner at least fifteen (15) days prior to the sale of the Timberland of the requirements under 14 CCR § 1104.1(a)(8)(C).

(C) If operations have been conducted, but not completed under the exemption, the new Timberland Owner shall:

1. submit a new notice, or

2. comply with the following:

a. harvest no additional timber;

b. meet stocking requirements of 14 CCR § 1104.1(a)(2)(B);

c. dispose of the Slash created under the exemption activities according to 14 CCR § 1104.1(a)(2)(D);

d. provide erosion control for skid trails, roads, Landings, and disturbed areas as required by the Forest Practice Rules.

e. submit a report within ninety (90) days of the change of Timberland ownership that items a through d above were completed.

(9) A Timberland Owner may request a waiver to the five-year limitation described in 14 CCR § 1104.1(a). The Director may grant the waiver upon finding that one of the following conditions exist:

(A) 1. the construction of a building approved by the appropriate county/city permitting process is listed in the accepted Notice of Conversion Exemption Timber Operations as the non-Timberland use after the conversion, and

2. the Timberland Owner demonstrates to the Director that substantial liabilities for building construction have been incurred on each conversion exemption that the Timberland Owner has received in the last 5 years at the time the waiver is requested, and

3. operations conducted on all exemptions issued to the Timberland Owner within the past 5 years, prior to the time the waiver is requested, have been conducted in a manner that meets or exceeds the intent of the Act and Rules or any corrective work required by the Director has been satisfactorily completed.

(B) the change of ownership which caused the previous notice to expire was not the result of the sale of the Timberland and the new Timberland Owner provides information demonstrating that the imposition of the 5-year limitation described in 14 CCR § 1104.1(a) would impose an undue hardship on the Timberland Owner.

(C) the notice has expired and no operations have been conducted.

(D) The Timberland Owner provides an explanation and justification for the need of a waiver that demonstrates that the imposition of the 5-year limitation described in 14 CCR § 1104.1(a) would impose an undue hardship on the Timberland Owner.

(b) Construction or maintenance of right-of-way by a public agency on its own or any other public property.

(c) The clearing of trees from Timberland by a private or public utility for construction of gas, water,

CALIFORNIA FOREST PRACTICE RULES

sewer, oil, electric, and communications (transmitted by wire, television, radio, or microwave) rights-of-way, and for maintenance and repair of the utility and right-of-way. The said right-of-way, however, shall not exceed the width specified in the Table of Normal Rights-of-Way Widths for Single Overhead Facilities and Single Underground Facilities and the supplemental allowable widths.

Nothing in this section shall exclude the applicable provisions of PRC §§ 4292 and 4293, and 14 CCR §§ 1250 through 1258 inclusive for fire hazard clearance from being an allowable supplement to the exempt widths.

(d) TABLE OF RIGHTS-OF-WAY WIDTHS FOR SINGLE OVERHEAD FACILITIES

(A single facility for overhead electric lines means a single circuit)

Utility	Size	Width
Electric (Overhead Distribution & Transmission Single Circuits)	0-33 KV	20'
	34-100 KV	45'
	101-200 KV (pole)	75'
	101-200 KV (tower)	80'
	201-300 KV (tower)	125'
	300 KV & above (tower)	200'
Telephone cable or open wire when underbuilt	All	30'
Communications (Radio, Television, Telephone & Microwave)	All	30'
Active or passive microwave repeater and/or radio sites	All	40'
Microwave paths emanating from antennas or passive repeaters	All	20' from edges of antenna or passive repeater, and following centerline path.
Radio & Television antennas	All	30' in all directions
Telephone cable or open wire when underbuilt	All	30'

(e) The above right-of-way widths for above ground facilities shall be allowed supplemental clearances as follows:

- (1)** Equal additional rights-of-way for each additional facility, including these allowable supplemental clearances under this section.
- (2)** Additional clearance widths for poles and towers, and for conductor sway as provided in PRC 4292 and 4293, and 14 CCR 1250 through 1258 inclusive, as applicable.
- (3)** Additional clearance for removal of danger trees as defined in 14 CCR 895.1.
- (4)** Additional land area for substation and switch yards, material storage and construction camps with clearance for firebreaks, and security fencing.

(f) TABLE OF RIGHTS-OF-WAY WIDTHS FOR SINGLE UNDERGROUND FACILITIES

CALIFORNIA FOREST PRACTICE RULES

Utility	Size	Width
Electric, Underground	4"-6" Conduit	50'
	More than 6" Conduit	60'
Gas, Oil, Water & Sewer (Underground pipe)	6" diameter or smaller	50'
	Over 6"-12" diameter	60'
	Over 12"-24" diameter	75'
	Over 24" diameter	100'
Penstocks, Siphons	All	100'
Ditches and Flumes	All	150'
Access Roads	All	Access road widths may be up to 14' with an additional 10' width at turnout locations, plus additional width for cuts and fills. Access roads shall be installed and maintained so as to comply with the Stream protection requirements and erosion control requirements of the Forest Practice Act, related regulations, and the District Forest Practice Rules.

(g) The above right-of-way widths for underground facilities and penstocks, syphons, ditches and flumes shall be allowed supplemental clearances as follows:

- (1) Additional width for cuts and fills.
- (2) Removal of trees or plants with roots that could interfere with underground facilities, or with cuts and fills for installation.
- (3) Additional clearance for removal of danger trees as defined in 14 CCR 895.1.
- (4) For compressor, metering and control stations on natural gas pipelines; including firebreaks and security fencing:
 - (A) 450 foot width at one side of right-of-way and 500 foot length along the compressor stations.
 - (B) 300 feet x 300 feet on or alongside the right-of-way for metering and control stations.

(h) In-lieu practices for Watercourse and lake protection zones as specified under Article 6 of these Rules, exceptions to Rules, and alternative practices are not allowed.

- (i) Harvesting of large old trees shall only occur when:
 - (1) the tree is not critical for the maintenance of a Late Successional Stand and
 - (2) an RPF attaches to the exemption an explanation and justification for the removal based on the RPF's finding that one or more of the criteria or conditions listed under subsection (A), (B), or (C) are met. The requirements of (i)(2) need not be met if an approved management document; including but not limited to a HCP, SYP, NTMP, WFMP, or PTEIR; addresses large old tree retention for the area in which the large old tree(s) are proposed for removal and the removal is in compliance with the retention standards of that document. All trees to be harvested pursuant to this subsection shall be marked by an RPF prior to removal.
 - (A) The tree(s) is a hazard to safety or property. The hazard shall be identified in writing by an RPF or professionally certified arborist;

CALIFORNIA FOREST PRACTICE RULES

(B) The removal of the tree(s) is necessary for the construction of a building as approved by the appropriate county/city permitting process and as shown on the county/city approved site plan, which shall be attached to the Notice of Exemption;

(C) The tree is dead or is likely to die within one year of the date of proposed removal, as determined by an RPF or professionally certified arborist.

1104.2 Exemption for Conversion of Non-TPZ Land for Subdivision Development

Timber Operations for the conversion of land not in the TPZ for subdivision development are exempt from this article, subject to all of the following conditions:

(a) The county board of supervisors or city council having jurisdiction has approved a tentative subdivision map pursuant to the Subdivision Map Act commencing with Gov. C. Sec. 66410.

(b) The county board of supervisors or city council having jurisdiction has granted required use permits and other necessary approvals.

(c) Before Timber Operations begin and before a THP is submitted, the Timberland Owner shall file a Notice of Exemption from Timberland Conversion Permit for Subdivision on a form prescribed by the Director. The notice shall include, but need not be limited to, the following:

(1) Names and addresses of Timberland Owner(s), Timber Owner(s), and developer(s).

(2) Documentation that a Notice of Determination has been filed with the Office of Planning and Research pursuant to PRC 21108 or with the appropriate county clerk pursuant to PRC 21152.

(3) Estimated date of completion of the project.

(4) Acres of Timberland to be converted.

(5) Legal property description of the conversion area.

(6) Signature, title, and date of signing of the Timberland Owner(s). In the case of a partnership, at least one of the partners shall sign the application. For a corporation, a corporate officer shall sign. In other cases of more than one owner, all owners shall sign. An agent may sign for the owner (s) if so designated in writing submitted with the Notice.

(7) Plat or map of the area to be converted.

(8) Documentation of the county or city tentative subdivision map approval, conditions of approval, required use permit, or other required county or city project approvals.

(d) Except as provided in this article, the applicable requirements of PRC 4511 through 4628 inclusive, PRC 5093.50 through 5093.68 inclusive, and all regulations adopted pursuant thereto shall apply to the Timber Operations.

(e) If the subdivision development project is not completed or is abandoned, the Director may take corrective action pursuant to PRC 4605-4611 to have restocked those parts of the area from which timber has been harvested and which do not meet the stocking requirements of this chapter. For purposes of this subsection, the project shall be deemed abandoned or not completed if:

(1) The county or city tentative map approval has expired; and

(2) No further work has been carried on to complete the subdivision for three years after the expected date of completion stated in the THP. The Director shall order inspections as needed to determine whether the project has been completed as proposed.

(f) Partial performance shall be recognized. Those portions of the subdivision shall be deemed completed and excluded from the stocking requirement where the development has been completed and residential services have been provided pursuant to the plan for development.

1104.3 Timberland Conversion Permit Fees

The applicant shall pay an application fee in the amount of \$600 [NOTE: The fee is \$700 if the land is zoned TPZ, see 1105.1. Also, there are DFG fees.] for the cost of processing an application for the conversion of Timberland to a non-timber growing use. Where the land proposed to be converted lies within a TPZ, the applicant shall also follow the requirements of 14 CCR § 1105.1. The fee(s) shall be submitted with the application to the Environmental Coordinator at the appropriate CAL FIRE Review Team Office listed under 14 CCR § 1032. Where actual state cost exceeds the application fee, the additional charge equal to the excess cost will be computed using State Administrative Manual Sections 8752.1 and 8740 (dated March 1990). The Department will keep the applicant informed of any additional charges and will advise the applicant of any estimated future costs. All additional charges shall be paid by the applicant to the

CALIFORNIA FOREST PRACTICE RULES

Department of Forestry and Fire Protection Accounting Office before the issuance of the Timberland Conversion Permit. Costs of recording the documents pursuant to this article shall be paid by the applicant.

1105 Application

The Conversion Permit application shall be in a form prescribed by the Director and shall require but not be limited to the following information:

The name and address of the applicant;

The name and address of the Timberland Owner of record;

The name and address of the Timber Owner;

The legal description, general plan designation, and zoned status of the proposed conversion area;

The proposed future use or uses of said area;

The dates when conversion is to be commenced and completed;

The approximate number of acres to be converted;

The zoned status of adjacent property;

A description of other land owned by the applicant in the surrounding area which could accommodate the proposed use or uses;

Together with a copy of the conversion plan.

The application shall be executed under penalty of perjury.

1105.1 Application Fees

In addition to the requirements of Section 1104.3, the applicant shall pay a fee in the amount of \$100 for the cost of processing an application for conversion where the land proposed to be converted lies within a TPZ. *[NOTE: The total of CAL FIRE fees is \$700. There may be additional fees from DFG.]* Fees for the recording of documents pursuant to this article shall be borne by the applicant.

1105.2 Director's Determination

The Director shall determine the applicant's bona fide intention to convert in light of the present and predicted economic ability of the applicant to carry out the proposed conversion; the environmental feasibility of the conversion, including, but not limited to, suitability of soils, slope, aspect, quality and quantity of water, and micro-climate; adequacy and feasibility of possible measures for mitigation of significant adverse environmental impacts; and other foreseeable factors necessary for successful conversion to the proposed land use.

1105.3 Conversion Plan

A conversion plan in a form prescribed by the Director shall become a part of the application. The plan conversion shall set forth in detail information pertaining to present and future use, soils, topography, conversion techniques, conversion time schedule and such other information as may be required and is applicable to the particular future use to which the land will be devoted.

1105.4 Additional Proof

The Director or the Board upon appeal may require that the applicant provide such further or additional proof or information as in the Director's or Board's judgment is necessary to allow him to decide whether or not to issue a Conversion Permit pursuant to PRC 4621.2 and 4623.

1106 Conversion Permit Issuance

(a) The Director shall issue a Conversion Permit if:

(1) In his judgment the bona fide intent of the applicant to convert is established;

(2) He makes the written findings pursuant to PRC 4621.2, when applicable;

(3) He makes the written findings pursuant to PRC 21081, if an environmental Impact report has been prepared;

(4) He finds that necessary and feasible mitigation measures have been incorporated into the proposed conversion; and

(5) He finds that no other proximate and suitable land not within a TPZ is available for the proposed

CALIFORNIA FOREST PRACTICE RULES

alternative use for lands within a TPZ, if PRC 4621.2 applies.

(b) The Board upon appeal shall apply the same standards as the Director in subsection (a) above in determining whether to issue a Conversion Permit.

1106.1 Contents of Conversion Permit

The Conversion Permit shall include, but not be limited to, the name of the permittee, identification of code section of the forest practice Rules and regulations from which the Timber Operations are exempt, description of the lands to which the Conversion Permit is applicable, and the period of time during which the Conversion Permit is valid.

1106.2 Timber Harvesting Plan Processing

Prior to the start of Timber Operations, the applicant shall submit to the Director a Timber Harvesting Plan applicable to Timber Operations set forth in the conversion plan. The THP may be submitted concurrently with the Timberland Conversion Permit application but the Director may not approve the THP until the Timberland Conversion Permit is issued.

1106.3 Recordation, Renewal, Transferability

(a) The permittee shall submit the Conversion Permit to the County Recorder for recording in each county in which the property is located before beginning any operations contemplated under said permit. Amendments, suspensions, revocations, and cancellations of Conversion Permits shall be recorded in the same manner.

(b) A Conversion Permit may be renewed by the Director upon a proper showing of cause and necessity by the permittee. The Director may deny renewal and require a new application if he finds that circumstances have substantially changed.

(c) The privilege granted to the permittee is nontransferable and non-assignable for any purpose without written approval of the Director.

1106.4 Conversion Permit Denial

(a) The Director shall deny a Conversion Permit:

(1) For any of the reasons set forth in PRC 4624;

(2) If, in the Director's judgment, the applicant has failed to provide satisfactory proof of his bona fide intent to convert;

(3) If the Director cannot make the findings required by PRC 21801, if an environmental Impact report has been prepared;

(4) If the Director finds that necessary and feasible mitigation measures have not been incorporated into the proposed conversion; or

(5) For lands within a TPZ, if PRC 4621.2 applies and the Director finds that other proximate and suitable land not within a TPZ is available for the proposed alternative use.

(b) The Board upon appeal shall deny a Conversion Permit for any of the reasons specified in subsection (a) above.

1106.5 Denial, Suspension, Revocation

(a) Except as provided in subsection (b), the Director may deny, suspend or revoke a Conversion Permit in accordance with the requirements of Article 9 (commencing with Sec. 4621) of Chapter 8, Part 2, Division 4 of the PRC, provided that all proceedings in connection with such action shall be conducted in accordance with the provisions of Chapter 5 (commencing with Sec. 11500) of Part 1, Division 3, Title 2 of the Gov. C.

(b) The Director may deny a Conversion Permit pursuant to PRC 4621.2(d) provided that all proceedings in connection with such action shall be conducted in accordance with the provisions of subsection (a) above, except that the applicant must request a hearing before the Board within 15 days of service of the denial. The hearing shall be commenced within 60 days from the filing of the appeal unless a later hearing date is mutually agreed upon by the applicant and the Board.

1107 Cancellation by Permittee

CALIFORNIA FOREST PRACTICE RULES

Upon application by the permittee for cancellation, the Conversion Permit may be cancelled by the Director upon such terms and conditions as he may set forth. Upon cancellation of the Conversion Permit, an agreement of cancellation, executed by the permittee and the Director, shall be recorded by the permittee in those counties in which the permit was originally recorded. Upon such recording, the subject land shall revert back to Timberland and stocking shall be established pursuant to PRC 4561 and 4561.3. The Director shall provide a copy of the cancellation agreement to the county assessors and the county planning directors of those counties in which the property is located.

1108 Coastal Zone Conversion

A Timberland Conversion Permit is required for conversion of coastal commercial Timberland to uses other than the growing of timber. Except as hereafter provided, conversion of any such Timberland shall be limited to providing for necessary timber processing and related facilities.

The Director, or the Board upon appeal, may approve conversion of coastal commercial Timberland for other than necessary timber processing and related facilities only if all of the following conditions are met:

- (a) Such conversion will not introduce new uses or significantly intensify existing uses that are incompatible with timber growing on areas adjacent to the area proposed for conversion, or that have a substantial adverse Impact on coastal resources, as determined by the Director, and
- (b) The area proposed for conversion is in a unit of noncommercial size as determined by the California State Coastal Commission or the zoning in a certified local coastal plan; and
- (c) The conversion complies with all other applicable laws, Rules, and regulations.

1109 Immediate Rezoning

Immediate rezoning of land within a TPZ shall be accomplished in compliance with one of the two procedures set forth in 14 CCR 1109.1 and 1110.

1109.1 City or County Tentative Approval

When a county Board of Supervisors or City Council tentatively approves an immediate rezoning pursuant to Gov. C. 51133, for which a Conversion Permit is also required, it shall forward the following to the Director: documentation of its tentative approval upon a four-fifths vote of the full body; copies of the Notices sent to landowners within one mile (1.61 km) of the exterior boundary of the land upon which immediate rezoning is proposed, and the formal findings that immediate rezoning is not inconsistent with the purpose of subdivision (j) of Sec. 3 of Article XIII of the State Constitution, and findings that rezoning is in the public interest, as required by Gov. C. 51133(a); minutes of public hearing(s), including hearings held by the appropriate local planning agency pursuant to the application for immediate rezoning and any related applications for local government general plan land use category change, conditional use permit, or other entitlement for use; copies of documents, plans, maps, and photographs submitted in conjunction with the said public hearing(s); and copies of completed environmental documentation submitted pursuant to the application for immediate rezoning.

Upon the receipt of the foregoing materials, the completed conversion application and conversion plan, and such further information as may be required, the Director shall determine whether or not to approve the conversion pursuant to PRC 4621.2. Upon approval of the conversion by the Director or by the Board upon appeal, the Director shall so notify the county Board of Supervisors or City Council, who may then finalize the immediate rezoning.

1109.2 Public Interest

In determining whether or not to make the written finding contained in PRC 4621.2(a)(1), the Director or the Board upon appeal shall consider the following elements of public interest:

- (a) Whether the alternative use will serve a public need; provide a public service; benefit the local community and region, including economic and social benefits; avoid damage or threatened damage to other property, especially public parks and other publicly-owned lands; or involve costs and secondary Impacts caused by services required by the alternative use.
- (b) The adverse environmental Impacts of the alternative use and mitigation thereof. Impacts shall

CALIFORNIA FOREST PRACTICE RULES

include, but not be limited to, Impacts on lakes, Streams, and other waters; wildlife; air quality; and aesthetics.

(c) The Impact on the long term timber supply capability of California, including the cumulative Impact from conversion of similar properties.

(d) The availability of proximate and suitable land to accommodate the alternative use which lies outside of a TPZ or which would involve the removal of lower quality Timberlands from productive use.

1109.3 No Substantial and Unmitigated Adverse Effect Upon Other Timberland Production Zones Within One Mile (1.609 km)

In determining whether or not to make the written finding contained in PRC 4621.2(a)(2), the Director or the Board upon appeal shall consider such adverse factors as increased fire hazard and risk, forest pest potential, mass land movement, gully and sheet erosion, increased windthrow, shock to nearby stands from exposure, harmful fumes, emissions, dust, discharge of waste or chemicals, unconfined grazing of livestock, diversion or impoundment of water, wildlife use changes damaging to other properties, and other potential adverse factors.

1109.4 Suitability of Soils, Slopes, and Watersheds

In determining whether or not to make the written finding contained in PRC 4621.2(a)(3), the Director or the Board upon appeal shall consider the following elements: whether the soil types and characteristics can support the proposed use, the Erosion Hazard Rating of the soils and slopes in light of the proposed use, potential mass land movement or subsidence possible harm to quality or quantity of water produced in the watershed, fire hazard and risk to the watershed, adverse effects to fish and wildlife from removal of habitat cover, and such other elements as appropriate.

1109.5 No Other Reasonable or Comparable Timber Growing Use

In determining pursuant to PRC 4621.2(c) whether or not Timberlands within a TPZ that are the subject of a conversion application may be put to another reasonable or comparable timber-growing use, the Director or the Board upon appeal shall consider timber stand volume, timber growth rate, timber site and soil, climate, potential markets, any other relevant factors.

1109.6 Supplemental Data and Opinions

As an aid to the Director or the Board upon appeal in making the findings and approving the proposed conversion pursuant to PRC 4621.2, the Director or the Board upon appeal may upon their own initiative consult with or request reports from appropriate experts. The Director or the Board upon appeal may also require the applicant to furnish appropriate and necessary information or documentation, including that from appropriate expert consultants at the applicant's expense.

1110 Conversion Permit Within TPZ Not Required

Requests for immediate rezoning for an area exempted from this article pursuant to 14 CCR 1104.1 shall be processed in accordance with Gov. C. 51134.

CHAPTER 4.5 Hearings [in Rule Counties]

Detailed Analysis Section

1115 Time for Request

The board of supervisors or planning commission of any county for which Rules have been adopted pursuant to Sec. 4516.5 of the PRC may request a public hearing on any timber harvesting plan or non-industrial timber management plan submitted for lands within the county. Such request must be made no later than one (1) calendar day after the pre-harvest inspection date. The request may be in writing, by phone, or by facsimile. The request must be for a specific plan that has been filed according to 14 CCR 1032. For good cause, the Director may extend the deadline.

CALIFORNIA FOREST PRACTICE RULES

1115.1 Scheduling

Upon receipt of a request pursuant to 14 CCR 1115, the Department shall schedule a public hearing to be held no more than twenty-five (25) and no less than five (5) calendar days from the date of the request.

1115.2 Notification

The Department shall notify the public of the fact that such a public hearing will be held. The notice shall include information on the time and location of the hearing. The notice shall be given at least five (5) days before the date that the public hearing will be held. At a minimum, a copy of the notice shall be mailed to the county requesting the hearing, the Review Team members, and other interested parties as identified pursuant to 14 CCR 1032.7(e), and publishing a copy of the notice in a newspaper of general circulation in the area.

1115.3 Conduct of Hearing

The Department shall conduct a public hearing upon timely request. A Department representative shall conduct the hearing. The Departmental representative should be familiar with the THP, NTMP or WFMP under review. The purpose of the public hearing is to gather information from the public regarding the proposed Timber Operation. The public hearing is considered to be an integral part of the multidisciplinary review of the THP, NTMP or WFMP. The comments of the public shall be electronically recorded by the Department, and may be recorded by any person present. No departmental action with regard to the approval or disapproval of a THP, NTMP or WFMP shall occur at the public hearing. The Department representative that conducted the hearing shall submit a written report of the hearing to the Departmental employee responsible for approval or disapproval of the Plan. The Department shall provide written responses to significant issues raised at the public hearing in the official response of the director required by 14 CCR 1037.8.

Z'BERG-NEJEDLY FOREST PRACTICE ACT

Z'berg-Nejedly Forest Practice Act Division 4, Chapter 8, Public Resources Code Effective January 1, 2024

Article 1. General Provisions

4511. Title of act.

This chapter shall be known as the Z'berg-Nejedly Forest Practice Act of 1973.

4512. Forest resources and Timberlands; utilization, restoration, and protection ; legislative findings and declarations.

(a) The Legislature hereby finds and declares that the forest resources and Timberlands of the state are among the most valuable of the natural resources of the state and that there is great concern throughout the state relating to their utilization, restoration, and protection.

(b) The Legislature further finds and declares that the forest resources and Timberlands of the state furnish high-quality timber, recreational opportunities, and aesthetic enjoyment while providing watershed protection and maintaining fisheries and wildlife.

(c) The Legislature thus declares that it is the policy of this state to encourage prudent and responsible forest resource management calculated to serve the public's need for timber and other forest products, while giving consideration to the public's need for watershed protection, fisheries and wildlife, sequestration of carbon dioxide, and recreational opportunities alike in this and future generations.

(d) It is not the intent of the Legislature by the enactment of this chapter to take private property for public use without payment of just compensation in violation of the California and United States Constitutions.

4512.5. Sequestration of carbon dioxide; legislative findings and declarations.

The Legislature finds and declares all of the following:

(a) State forests play a critical and unique role in the state's carbon balance by sequestering carbon dioxide from the atmosphere and storing it long term as carbon.

(b) According to the scoping plan adopted by the State Air Resources Board pursuant to the California Global Warming Solutions Act of 2006 (Division 25.5 (commencing with Section 38500) of the Health and Safety Code), the state's forests currently are an annual net sequesterer of five million metric tons of carbon dioxide (5MMTCO₂). In fact, the forest sector is the only sector included in the scoping plan that provides a net sequestration of Greenhouse Gas emissions.

(c) The scoping plan proposes to maintain the current 5MMTCO₂ annual sequestration rate through 2020 by implementing "sustainable management practices," which include potential changes to existing forest practices and land use regulations.

(d) There is increasing evidence that climate change has and will continue to stress forest ecosystems, which underscores the importance of proactively managing forests so that they can adapt to these stressors and remain a net sequesterer of carbon dioxide.

(e) The Board, the Department, and the State Air Resources Board should strive to go beyond the status quo sequestration rate and ensure that their policies and regulations reflect the unique role forests play in combating climate change.

4513. Timberlands; creation and maintenance of system of regulation and use; legislative intent.

It is the intent of the Legislature to create and maintain an effective and comprehensive system of regulation and use of all Timberlands so as to ensure both of the following:

(a) Where feasible, the productivity of Timberlands is restored, enhanced, and maintained.

(b) The goal of maximum sustained production of high-quality timber products is achieved while giving consideration to values relating to sequestration of carbon dioxide, recreation, watershed, wildlife, range and forage, fisheries, regional economic vitality, employment, and aesthetic

Z'BERG-NEJEDLY FOREST PRACTICE ACT

enjoyment.

4514. Chapter, ruling, requirement, or policy of board as not limiting specified powers and rights.

This chapter or a ruling, requirement, or policy of the board is not a limitation on the following:

- (a) On the power of a city or county or city and county to declare, prohibit, and abate nuisances.
- (b) On the power of the Attorney General, at the request of the board, or upon his or her own motion, to bring an action in the name of the people of the State of California to enjoin pollution or nuisance.
- (c) On the power of a state agency in the enforcement or administration of the law that it is specifically authorized or required to enforce or administer.
- (d) On the right of a person to maintain at any time an appropriate action for relief against a private nuisance as defined in Part 3 (commencing with Section 3479) of Division 4 of the Civil Code or for any other private relief.

4514.3. Exemption from waste discharge requirements; conditions.

(a) Timber Operations conducted pursuant to this chapter are exempt from the waste discharge requirements of Article 4 (commencing with Section 13260) of Chapter 4 of Division 7 of the Water Code as long as both the federal Environmental Protection Agency and the State Water Resources Control Board certify after January 1, 2003, that the provisions of this chapter constitute best management practices for silviculture pursuant to Section 208 of the Federal Water Pollution Control Act.

- (b) The exemption contained in subdivision (a) does not apply when any of the following occurs:
- (1) The board requests issuance of waste discharge requirements.
 - (2) There has been a finding by the State Water Resources Control Board that the board has failed to maintain a water quality regulatory process consistent with the certification required under subdivision (a).
 - (3) After monitoring the water quality Impacts from Timber Operations conducted in compliance with this chapter, there has been a finding by the State Water Resources Control Board that compliance with best management practices would result in less water quality protection than required in water quality control plans approved pursuant to Section 13245 of the Water Code.

4514.5. Writ of mandate.

A person may commence an action on his own behalf against the board or the department for a writ of mandate pursuant to Chapter 2 (commencing with Section 1084) of Title 1 of Part 3 of the Code of Civil Procedure to compel the board or the department to carry out a duty imposed upon them pursuant to this chapter.

4516. Agency Rules and regulations.

Notwithstanding any provision of this chapter, the California Tahoe Regional Planning Agency shall have the right, within the reasonable exercise of its powers, to adopt Rules and regulations by ordinance or resolution which are stricter than those provided under this chapter and regulations adopted pursuant to this chapter. The agency's Rules and regulations may include, but are not limited to, matters relating to soil erosion control, protection of stream character and water quality, flood control, stand density control, reforestation methods, mass soil movements, submission of timber harvesting plans, location and grade of roads and skid trails, excavation and fill requirements, Slash and debris disposal, haul routes and schedules, hours and dates of logging, and performance bond requirements. Whenever state funds are not expended for the support of the California Tahoe Regional Planning Agency, as provided in Section 67131 of the Government Code, the Tahoe Regional Planning Agency shall have the right to adopt Rules and regulations pursuant to this section.

4516.5. County recommendation of Rules and regulations; Timber Operations; board Rules and regulations; limitation on enforcement and validity of local ordinances, Rules and regulations; applicability of section.

(a) Individual counties may recommend that the board adopt additional Rules and regulations for the content of timber harvesting plans and the conduct of Timber Operations to take account of local needs. For

Z'BERG-NEJEDLY FOREST PRACTICE ACT

purposes of this section, "Timber Operations" includes, but is not limited to, soil erosion control, protection of stream character and water quality, water distribution systems, flood control, stand density control, reforestation methods, mass soil movements, location and grade of roads and skid trails, excavation and fill requirements, Slash and debris disposal, haul routes and schedules, hours and dates of logging, and performance bond or other reasonable surety requirements for onsite Timber Operations and for protection of publicly and privately owned roads that are part of the haul route. Where a bond or other surety has been required, the director shall not issue a work completion report without first ascertaining whether the county in which the Timber Operations were conducted has knowledge of any claims intended to be made on the bond or surety.

(b) The board shall, in conformance with Chapter 3.5 (commencing with Section 11340) of Part 1 of Division 3 of Title 2 of the Government Code and within 180 days after receiving recommended Rules and regulations from a county, adopt Rules and regulations for the content of timber harvesting plans and the conduct of Timber Operations consistent with the recommended if the board finds the recommended Rules and regulations are both of the following:

- (1) Consistent with the intent and purposes of this chapter.
- (2) Necessary to protect needs and conditions of the county recommending them.

(c) The Rules and regulations, if adopted by the board, shall apply only to the conduct of Timber Operations within the recommending county and shall be enforced and implemented by the department in the same manner as other Rules and regulations adopted by the board.

(d) Except as provided in subdivision (e), individual counties shall not otherwise regulate the conduct of Timber Operations, as defined by this chapter, or require the issuance of any permit or license for those operations.

(e) The board may delegate to individual counties its authority to require performance bonds or other surety for the protection of roads, in which case, the procedures and forms shall be the same as those used in similar circumstances in the county. The board may establish reasonable limits on the amount of performance bonds or other surety which may be required for any timber operation and criteria for the requirement, payment, and release of those bonds or other surety. If the county fails to inform the director of the claims within 30 days after the completion report has been filed, the bond or surety shall be released.

(f) This section does not apply to Timber Operations on any land area of less than three acres and which is not zoned Timberland production.

4516.6. Delay between approval and commencement of Timber Operations; waiver; appeal of approval.

(a) To provide for adequate public review and comment, notwithstanding Section 4582.7, the director shall not approve a timber harvesting plan in any county for which Rules and regulations have been adopted pursuant to Section 4516.5 or 4516.8 until 35 days from the date of filing of the plan, and Timber Operations shall not commence until five days from the date of approval of the plan. The board may provide, by regulation, for those periods to be waived or shortened by the department upon a determination, pursuant to criteria and procedures established by the board, that the proposed Timber Operations will cause no significant environmental damage or threat to public health and safety or to the environment, or that the Timber Operations are necessary to reduce that threat. If the chairperson of the board of supervisors of the county in which the proposed Timber Operations are located notifies the director and the plan submitter that the county intends to appeal the approval of the plan and that the county meets the requirements for filing an appeal, no Timber Operations shall occur until the final determination of the appeal. If the board of supervisors determines not to appeal the approval of the plan, it shall immediately notify the director and the plan submitter in writing of that determination, and Timber Operations pursuant to the plan may commence immediately.

(b) (1) The board of supervisors of the county for which Rules and regulations have been adopted pursuant to Section 4516.5 or 4516.8 may, not later than 10 days after approval of the plan by the director, appeal that approval to the board, if the county has both participated in the initial inspection of the plan area with the director and participated in a multidisciplinary review of the plan.

(2) The board may establish procedures for filing the appeal and may specify findings that the board of supervisors is required to make in filing the appeal to demonstrate that a substantial issue is raised with

Z'BERG-NEJEDLY FOREST PRACTICE ACT

respect to public health and safety or the environment.

(c) The board shall grant to a county that meets the requirements for filing an appeal an initial hearing to consider the county's request for an appeal at the next regularly scheduled board meeting following the receipt of the request.

(d) The board shall grant a public hearing on the appeal if it determines at an initial hearing pursuant to subdivision (c) that the appeal raises substantial issues with respect to public health and safety or the environment.

(e) (1) The board shall hold a public hearing on the appeal granted pursuant to subdivision (d) within 30 days from the date of granting the hearing or at the next regularly scheduled board meeting, whichever occurs first, or within a longer period of time that is mutually agreed upon by the board, the county, and the plan submitter. Upon conclusion of the hearing, the board shall approve or deny the plan. The basis of the board's decision shall be conformance with this section and the Rules and regulations of the board, including any Rules or regulations enacted with respect to the county pursuant to Section 4516.5 or 4516.8, and this chapter. In denying a plan, the board may make findings that set forth conditions under which it believes that the plan would have been approved.

(2) The board may delegate conduct of the hearing and the decision to a committee of three members to be appointed for that hearing by the chairperson of the board. The committee shall consist of at least two general public members of the board. The chairperson of the board or the chairperson's designee shall conduct the hearing. The decision of the committee shall have the full force and effect of a decision of the full board.

(f) This section does not apply to Timber Operations on any land area of less than three acres and that is not zoned for Timberland production.

4516.8. Recommendations by counties for adoption of additional Rules and regulations.

In addition to the authority provided in Section 4516.5, the Counties of Marin, Monterey, San Mateo, Santa Clara, and Santa Cruz may recommend that the board adopt additional Rules and regulations for the content of timber harvesting plans and the conduct of Timber Operations which provide a requirement that each timber harvesting plan contain a description of all log hauling routes, a statement of whether an encroachment permit is required by any public agency, and a requirement that no timber harvesting plan be approved by the director without the condition that the Timber Operator secure all required encroachment permits prior to commencement of Timber Operations.

4517. Severability.

If any provision of this chapter or the application thereof to any person or circumstance is held invalid, such invalidity shall not affect other provisions or applications of the chapter which can be given effect without the invalid provision or application, and to this end the provisions of this chapter are severable.

Article 2. Definitions.

4521. Definitions.

Unless the context otherwise requires, the definitions set forth in this article shall govern the construction of this chapter.

4521.3. Board.

"Board" means the State Board of Forestry and Fire Protection.

4523. District.

"District" means a forest district.

4524. License.

"License" means a license to engage in Timber Operations, issued pursuant to Article 6 (commencing with Section 4571) of this chapter.

Z'BERG-NEJEDLY FOREST PRACTICE ACT

4525. Person.

"Person" includes any private individual, organization, partnership, corporation, limited liability company, city, county, district, or the state or any department or agency thereof.

4525.3. Resource conservation standards.

"Resource conservation standards" means the minimum acceptable condition resulting from Timber Operations.

4525.5. Rules.

"Rules" means the district forest practice Rules adopted by the board.

4525.7. Slash.

"Slash" means branches or limbs less than four inches in diameter, and bark and split products debris left on the ground as a result of Timber Operations.

4526. Timberland.

"Timberland" means land, other than land owned by the federal government and land designated by the board as experimental forest land, which is available for, and capable of, growing a crop of trees of a commercial species used to produce lumber and other forest products, including Christmas trees. Commercial species shall be determined by the board on a district basis.

4526.5. Timber Operator.

"Timber Operator" means a person who is engaged in Timber Operations or who contracts with others to conduct the operations on his or her behalf, except a person who is engaged in Timber Operations as an employee with wages as his or her sole compensation.

4527. Timber Operations; commercial purposes; criteria.

(a) (1) "Timber Operations" means the cutting or removal, or both, of timber or other solid wood forest products, including Christmas trees, from Timberlands for commercial purposes, together with all the incidental work, including, but not limited to, construction and maintenance of roads, fuel breaks, firebreaks, stream crossings, Landings, skid trails, and beds for the falling of trees, fire hazard abatement, and Site Preparation that involves disturbance of soil or burning of vegetation following timber harvesting activities, but excluding preparatory work such as treemarking, surveying, or roadflagging.

(2) "Commercial purposes" includes (A) the cutting or removal of trees that are processed into logs, lumber, or other wood products and offered for sale, barter, exchange, or trade, or (B) the cutting or removal of trees or other forest products during the conversion of Timberlands to land uses other than the growing of timber that are subject to the provisions of Section 4621, including, but not limited to, residential or commercial developments, production of other agricultural crops, recreational developments, ski developments, water development Projects, and transportation Projects.

(b) For purposes of this section, the removal of trees less than 16 inches in diameter at breast height from a firebreak or fuelbreak does not constitute "Timber Operations" if the removal meets all of the following criteria:

(1) It is located within 500 feet of the boundary of an urban wild land interface community at high risk of wildfire, as defined in pages 751 to 776, inclusive of Volume 66 of the Federal Register (66 FR 751-02), as that definition may be amended from time to time. For purposes of this paragraph, "urban wildland interface community at high risk of wildfire" means an area having one or more structures for every five acres.

(2) It is part of a community wildfire protection plan approved by the department or part of a department fire plan.

(3) The trees to be removed will not be processed into logs or lumber, unless the work is being conducted by, or in partnership with, a public agency or a nonprofit organization that has received a grant from the department for vegetation management or fuel reduction, in which case the logs or lumber may be sold.

Z'BERG-NEJEDLY FOREST PRACTICE ACT

(4) The work to be conducted is under a firebreak or fuelbreak project that has been subject to a project-based review pursuant to a negative declaration, mitigated negative declaration, or environmental Impact report in compliance with the California Environmental Quality Act (Division 13 (commencing with Section 21000)). For Projects to be conducted on forested landscapes, as defined in Section 754, the project and the project-based review shall be prepared by or in consultation with a registered professional forester.

(5) The removal of surface and ladder fuels is consistent with paragraph (9) of subdivision (k) of Section 4584, as that section read on December 31, 2018.

4527.5. Timber Owner.

"Timber Owner" means a person who owns commercial timber, Timberland, or timber rights, including Christmas tree rights, on lands of another except a federal agency.

4528. Additional definitions.

As used in this chapter:

(a) "Basal Area Per Acre" means the sum of the cross-sectional areas at breast height of the tree stems of commercial species per acre.

(b) "Countable tree" means a tree that can be used in calculating the degree of stocking under the following criteria:

(1) The tree must be in place at least two growing seasons.

(2) The tree must be live and healthy.

(3) The tree must have at least one-third of its length in live crown, except in pure stands of Douglas-fir, the tree must have at least one-fourth of its length in live crown.

(4) The tree must be a commercial species from a local seed source or a seed source which the registered professional forester determines will produce commercial trees physiologically suited for the area involved.

(c) "Stocking" means a measure of the degree to which space is occupied by well-distributed countable trees.

(d) "Site classification" means the classification of productive potential of Timberland into one of five classes by board regulation, consistent with normally accepted forestry practices. Site I shall denote sites of highest productivity, site II and site III shall denote sites of intermediate productivity potential, and site IV and V shall denote sites of lowest productivity potential.

(e) "Fuel break" means a strip of modified fuel to provide a line from which to work in the control of fire.

(f) "Stream" means a natural Watercourse as designated by a solid line or dash and three dots symbol shown on the largest scale United States Geological Survey map most recently published.

4528.5. Applicability to employees.

This chapter does not apply to a person who engages in activities regulated by this chapter, as an employee, with wages as his or her sole compensation.

4529. Penalties and remedies, concurrent and alternative.

The penalties and remedies which are prescribed in this chapter are concurrent and alternative to any other civil, criminal, or administrative rights, remedies, or penalties which are provided or allowed by law with respect to such violation.

4529.5. Forms of service.

Service of documents where required under this chapter may be made by registered or certified mail addressed to the respondent's latest address registered on file with the department. Where other forms of service are prescribed, personal service is not precluded.

Article 3. Districts.

4531. Establishment of districts.

Z'BERG-NEJEDLY FOREST PRACTICE ACT

The board shall divide the state into not less than three districts. In establishing these districts, the board shall take into account differing physical characteristics, including, but not limited to, climate, soil type, and principal forest crops. Insofar as possible, the board shall group together lands that have substantially similar characteristics and that will best be served by substantially similar regulations. Boundaries of such districts may be altered from time to time as the board determines is necessary.

Article 4. Rules and Regulations.

4551. Adoption of district forest practice Rules and regulations; factors considered in Rules and regulations governing harvesting of commercial tree species; funding.

(a) The board shall adopt district forest practice Rules and regulations for each district in accordance with the policies set forth in Article 1 (commencing with Section 4511) of this chapter and pursuant to Chapter 3.5 (commencing with Section 11340) of Part 1 of Division 3 of Title 2 of the Government Code to ensure the continuous growing and harvesting of commercial forest tree species and to protect the soil, air, fish and wildlife, and water resources, including, but not limited to, streams lakes and estuaries.

(b) (1) The Board shall ensure that its Rules and regulations that govern the harvesting of commercial tree species, where applicable, consider the capacity of forest resources, including above ground and below ground biomass and soil, to sequester carbon dioxide emissions sufficient to meet or exceed the state's Greenhouse Gas reduction requirements for the forestry sector, consistent with the scoping plan adopted by the State Air Resources Board pursuant to the California Global Warming Solutions Act of 2006 (Division 25.5 (commencing with Section 38500) of the Health and Safety Code).

(2) The costs of the contracts for research studies or technical analyses initiated by the Board or the Department to comply with paragraph (1) shall be funded, upon appropriation by the Legislature, from fee revenues collected pursuant to Section 38597 of the Health and Safety Code.

4551.3. Sustained yield plan; effective period; monitoring process; public hearings; notice.

(a) A sustained yield plan that is prepared and approved in accordance with Rules and regulations adopted by the board pursuant to Section 4551, including Article 6.75 (commencing with Section 1091.1) of Subchapter 7 of Chapter 4 of Division 1.5 of Title 14 of the California Code of Regulations, shall be effective for a period of no more than 20 years.

(b) As part of the continuing monitoring process for an approved sustained yield plan, as described in subdivision (a), the department shall hold a public hearing on the plan if requested by an interested party who submits, in writing, a request based on substantial evidence of potential noncompliance with any of the following:

(1) The terms and conditions of the original sustained yield plan approval.

(2) The applicable Rules or regulations adopted by the board that were in effect on the date the sustained yield plan was originally approved.

(3) Other requirements that have been imposed on the sustained yield plan by operation of law.

(c) The request shall identify specific issues in the sustained yield plan to be addressed at the public hearing. To be considered, a request shall be made to the department within six months after the midpoint of the effective term of a sustained yield plan described in subdivision (a). The department shall hold the public hearing within 120 days after the date of the close of the six-month request period. A sustained yield plan shall be effective for the remainder of its term unless the director makes written findings, based on a preponderance of evidence, that implementation of the sustained yield plan is not in compliance with any material provision of paragraph (1), (2), or (3) of subdivision (b).

(d) If a public hearing is required, the director shall provide at least 30 days' notice to the sustained yield plan submitter and the public and shall provide for a record of the hearing, pursuant to regulations adopted by the board.

Z'BERG-NEJEDLY FOREST PRACTICE ACT

4551.5. Application; development.

Rules and regulations shall apply to the conduct of Timber Operations and shall include, but shall not be limited to, measures for fire prevention and control, for soil erosion control, for Site Preparation that involves disturbance of soil or burning of vegetation following timber harvesting activities, for water quality and watershed control, for flood control, for stocking, for protection against Timber Operations that unnecessarily destroy young timber growth or timber productivity of the soil, for prevention and control of damage by forest insects, pests, and disease, for the protection of natural and scenic qualities in special treatments areas identified pursuant to subdivision (b) of Section 30417, and for the preparation of timber harvesting plans. In developing these Rules, the board shall solicit and consider recommendations from the department, recommendations from the Department of Fish and Game relating to the protection of fish and wildlife, recommendations from the State Water Resources Control Board and the California regional water quality control boards relating to water quality, recommendations from the State Air Resources Board and local air pollution control districts relating to air pollution control, and recommendations of the California Coastal Commission relating to the protection of natural and scenic coastal zone resources in Special Treatment Areas.

4551.7. Site Preparation.

The board shall, on or before November 1, 1988, adopt regulations pertaining to Site Preparation that involves disturbance of soil or burning of vegetation following timber harvesting activities conducted after January 1, 1988.

4551.9. Regulations with respect to requiring a map or maps with timber harvesting plans; conditions and contents of maps; Impact on smaller landowners.

(a) On or before January 1, 2005, the board shall adopt regulations to require that a timber harvesting plan include a map or maps, depicting the location and boundaries of past, present, and Reasonably Foreseeable Probable Future Projects, as defined in Section 21065 and Section 895.1 of Title 14 of the California Code of Regulations, on land owned or controlled by the applicant in the planning watershed. The board may not require an applicant to furnish maps of Projects completed more than 10 years prior to the submission of the timber harvesting plan. Maps shall include silvicultural prescription. The scale and format of maps provided pursuant to this subdivision shall be determined by the board. This subdivision may not be construed to require disclosure of proprietary information to the public.

(b) The board shall consider the Impact of the regulations on smaller landowners, and avoid excessive burdens or costs on those landowners.

4552. Basis of Rules and regulations; standards for preparing harvesting plans.

The Rules and regulations adopted by the board shall be based upon a study of the factors that significantly affect the present and future condition of Timberlands and shall be used as standards by persons preparing timber harvesting plans. In those instances in which the board intends the director to exercise professional judgment in applying any rule, regulation, or provision of this chapter, the board shall include in its Rules standards to guide the actions of the director, and the director shall conform to such standards, consistent with Section 710.

4553. Review and revision of Rules and regulations.

The Rules and regulations shall be continuously reviewed and may be revised. During the formulation or revision of the Rules and regulations, the board shall consult with, and carefully evaluate the recommendations of, the department, concerned federal, state, and local agencies, educational institutions, civic and public interest organizations, and private organizations and individuals.

4554. Public hearing for adoption or revision of Rules, etc.; notice.

Except for emergency regulations or orders of repeal adopted pursuant to Article 5 (commencing

Z'BERG-NEJEDLY FOREST PRACTICE ACT

with Section 11346) of Chapter 3.5 of Part 1 of Division 3 of Title 2 of the Government Code, the board shall not adopt or revise Rules, regulations, or resource conservation standards unless a public hearing is first held respecting their adoption or revision. At least 30 days prior to the hearing, the board shall give notice of the hearing by publication pursuant to Section 6061 of the Government Code.

4554.5 Rules and regulations; effective dates.

(a) Notwithstanding Section 11343.4 of the Government Code, except as specified in subdivision (b), Rules and regulations adopted or revised pursuant to this chapter shall become effective on the next January 1 that is not less than 30 days from the date of approval of those Rules or regulations by the Office of Administrative Law.

(b) Notwithstanding subdivision (a), if the board adopts emergency regulations pursuant to Section 4555, and subsequently adopts those emergency regulations as nonemergency Rules or regulations pursuant to this chapter, the Rules and regulations shall become effective 30 days from the date of approval of the Rules or regulations by the Office of Administrative Law.

(c) This section shall become operative on January 1, 2001.

4555. Withholding decisions; emergency regulations.

If the director determines that a substantial question exists concerning whether the intent of this chapter is currently provided for by the Rules and regulations of the board, and that approval of a timber harvesting plan which has been filed could result in immediate, significant, and long-term harm to the natural resources of the state, the director may withhold decision on a timber harvesting plan. However, within five days of that action, the director shall notify the board of that action. Within 30 days of the receipt of the notice, the board shall, after a public hearing, make a determination as to whether or not the intent of this chapter has been provided for in the Rules and regulations of the board. The determination shall be conclusive.

If the board finds that the intent of this chapter has not been provided for in the Rules and regulations, the board shall act to amend the Rules by emergency regulation in accordance with Chapter 3.5 (commencing with Section 11340) of Part 1 of Division 3 of Title 2 of the Government Code. The director shall act upon the plan within 15 days of the board's action. Emergency regulations adopted pursuant to this section shall be effective for not more than 120 days. The regulations may be made permanent if the board acts to adopt or revise its Rules and regulations pursuant to procedures established in this article for the adoption of other than emergency regulations.

4556. Forest management task force.

(a) The Forest Management Task Force shall report to the Legislature on or before July 1, 2020, on opportunities to streamline this act and associated rules and regulations to expedite forest health Projects and fire prevention Projects while preserving the resource protection functions of the act.

(b) (1) A report submitted pursuant to this section shall be submitted in compliance with Section 9795 of the Government Code.

(2) Pursuant to Section 10231.5 of the Government Code, this section is repealed on July 1, 2024.

Article 5. Resource Conservation Standards.

4561. Stocking standards.

It is the purpose of this section to set forth resource conservation standards for Timber Operations, and to ensure that a cover of trees of commercial species, sufficient to utilize adequately the suitable and available growing space, is maintained or established after Timber Operations.

To that end, the following resource conservation standards define minimum acceptable stocking, and an area covered by a timber harvesting plan shall be classified as acceptably stocked if either of the following conditions exist within five years after completion of Timber Operations:

(a) The area contains an average point count of 300 per acre, except that in areas which the

Z'BERG-NEJEDLY FOREST PRACTICE ACT

registered professional forester who prepares the timber harvesting plan has determined are site IV classification or lower, the minimum average point count shall be 150 per acre. Point count shall be computed as follows:

(1) A countable tree that is not more than four inches in diameter at breast height to count as one.

(2) A countable tree over four inches and not more than 12 inches in diameter at breast height to count as three.

(3) A countable tree over 12 inches in diameter at breast height to count as six.

(b) (1) The average residual basal area, measured in stems one inch or larger in diameter is at least 85 square feet per acre, except that in areas that the registered professional forester who prepares the timber harvesting plan has determined are site II classification or lower, the minimum average residual basal area shall be 50 square feet per acre.

(2) The board, on a finding that it is in furtherance of the purposes of this chapter, may encourage selection, shelterwood, or other types of management of timber if consistent with the biological requirements of the tree species and may regulate the size and shape of areas in which even-age management of timber is utilized.

(3) Rock outcroppings and other areas not normally bearing timber shall not be considered as requiring stocking and are exempt from the stocking provisions.

4561.1. Application of standards; board standards.

The resource conservation standards relating to stocking enumerated in Section 4561 shall constitute minimum requirements, and these shall be the standards to which all timber harvesting plans shall conform unless the board adopts higher stocking standards for each district. The board shall adopt standards for each district, after a public hearing, which are equal to or stricter than the standards of this chapter and shall report such standards to the Legislature.

It is not the intent of the Legislature in designating minimum standards that such standards shall be deemed to be preferred as the standards to be adopted by the board. The board may, by a majority vote as provided in Section 736, adopt higher minimum standards of stocking if, in the opinion of the board, growing conditions, tree species, site quality, or other factors justify such stricter standards and if such action is consistent with the purposes of this article.

4561.2. Alternative stocking standards.

Notwithstanding Section 4561.1 or the resource conservation standards relating to stocking pursuant to Section 4561, the board may adopt alternative stocking standards that meet the purposes of Section 4561 if those alternative standards reasonably address the variables in forest characteristics, achieve suitable resource conservation, and contribute to specific forest health and ecological goals as defined by the board.

4561.5. Permanent stocking standards; adoption and amendment.

The board shall, after a public hearing, adopt, and may from time to time, after a public hearing, amend permanent stocking standards applicable to commercial Timberland where the growing timber does not meet the acceptable stocking standards as enumerated in Section 4561.

4561.7. Site designated for testing purposes; exemption from stocking requirement; testing location.

(a) The site designated for testing purposes by subdivision (b) is exempt from any stocking requirements.

(b) Testing may be permitted only on a 35-acre area located in the Pudding Creek drainage of Mendocino County in Sections 19 and 30, T19N, R16W, M.D.B. & M.

4562. Fire protection zone Rules.

In order to reduce the incidence and spread of fire on Timberlands, the board shall adopt Rules in the fire protection zone as such zone is defined by the board, including, but not limited to, land along

Z'BERG-NEJEDLY FOREST PRACTICE ACT

either side of the rights-of-way along public roads in widths to be determined by rule by the board in various areas, and in such other areas as the board deems necessary, to govern the disposal of solid non-forest wastes and Slash created by Timber Operations.

4562.5. Control of soil erosion; regulations.

It is the purpose of this section to insure that soil erosion associated with Timber Operations is adequately controlled to protect soil resources, forest productivity, and water quality. The prevention, retardation, and control of accelerated erosion are the principal goals of this section. The board shall conduct such investigations of soil characteristics and erosion rates and of the instruments, techniques, and procedures available for use in monitoring soil loss as will facilitate the development and application of soil resource conservation standards, and shall, by January 1, 1976, publish reports or otherwise disseminate the information thus obtained, including a determination, if possible, of permissible levels of soil loss. The board shall promulgate regulations for each district to govern Timber Operations that may cause significant soil disturbance.

4562.7. Protection of streams; Rules.

The purpose of this section is to ensure the protection of beneficial uses that are derived from the physical form, water quality, and biological capability of streams. To these ends, in addition to the Rules provided for in Section 4551.5, the board shall adopt Rules for control of Timber Operations that will result or threaten to result in unreasonable effects on the beneficial uses of the waters of the state. The Rules shall include Rules for:

- (a) The disposal of petroleum products, sanitary wastes, refuse, and cleaning agents in proper dumps or waste treatment facilities to prevent them from entering streams.
- (b) Construction of Logging Road and tractor trail stream crossings to assure substantially unimpaired flow of water and to assure free passage of fish both upstream and downstream.
- (c) Minimizing damage to unmerchantable streamside vegetation, particularly hardwood trees.
- (d) Minimizing damage to streambeds or banks resulting from Skidding or hauling logs through, across, or into streams, by operating tractors or other heavy equipment in or near streambeds, or by construction of log Landings or Logging Roads in or near the channels of streams.
- (e) Control of Slash, debris, fill, and side cast earth, resulting from Timber Operations, which may be carried into streams.
- (f) Minimizing the effects of erosion on Watercourses and lakes by both of the following:
 - 1. Installation and maintenance of drainage facilities and soil stabilization treatments as required on Timber Operations.
 - 2. Planned Abandonment of roads and Landings.

4562.9. Maintenance of installed drainage facilities and soil stabilization treatments; regulations.

The board shall adopt regulations requiring maintenance of installed drainage facilities and soil stabilization treatments on skid trails, roads, and Landings for a period of at least one year, but not to exceed three years, after filing of the work completion report, if the report is approved.

Article 6. Licenses.

4570. Real Person in Interest.

For purposes of this article, "real person in interest" means an individual who is one of the following:

- (a) The sole proprietor, principal owner, or principal officer of an entity that is applying for license or the renewal of a license under this article.
- (b) The on-site supervisor responsible for the conduct of Timber Operations pursuant to the license, including the authority to hire and fire persons conducting those Timber Operations.

4571. Necessity of license.

Z'BERG-NEJEDLY FOREST PRACTICE ACT

- (a) No person shall engage in Timber Operations until he has obtained a license from the board.
- (b) The board may issue a limited Timber Operator license for the commercial cutting or removal of Christmas trees, treebark, fuelwood, root crown burls, posts, or split products.

4572. Form and content of application; procedures; filing fee.

(a) The board shall by regulation, prescribe the form and content of an application for a Timber Operator license or license renewal, establish procedures for filing the application, and require a reasonable filing fee. The amount of the filing fee shall not exceed the amount necessary to administer licensing under this article.

(b) First-time applicants for a Timber Operator license shall furnish to the board proof that the real person in interest has complied with both of the following requirements:

(1) Completion, within the preceding 12 months, of an education program approved by the director that covers the statutes and regulations governing Timber Operations in this state.

(2) (A) Except as specified in subparagraph (B) and subdivision (d), completion of 3000 hours of work experience in two or more areas of employment in Timber Operations.

(B) An applicant shall be exempt from this paragraph if the applicant furnishes proof to the board that the applicant is sole proprietor of, principal owner of, or principal officer of an entity that owns, the land on which all Timber Operations under the license will be conducted, and the applicant will supervise those Timber Operations.

(c) (1) Except as specified in paragraph (2) and subdivision (d), all applicants shall file with the director written evidence of timber operation insurance coverage under an insurance policy issued by an insurer eligible to do business in this state that includes both of the following:

(A) Commercial general liability insurance for not less than one million dollars (\$1,000,000) per occurrence for bodily injury and property damage combined, including within that limit, or in a separate limit, loggers third party property damage liability.

(B) A provision requiring the insurer to provide to the director a certificate of insurance and notice of any amendment to, or cancellation of, the policy within 30 days from the date of policy amendment or cancellation.

(2) This subdivision does not apply to an applicant who owns the land upon which the Timber Operations are to be conducted pursuant to the license.

(d) Subparagraph (A) of paragraph (2) of subdivision (b) and paragraph (1) of subdivision (c) does not apply to applicant for a limited Timber Operator license.

4573. Reasons for denial.

The board may deny a Timber Operator license for any of the following reasons:

- (a) The applicant is not the real person in interest.
- (b) Material misrepresentation or false statement in the application.
- (c) Conviction within one year of the application of unlawfully operating without a license.
- (d) The failure or refusal of the applicant to comply with this chapter or the Rules and regulations adopted by the board pursuant to this chapter, within three years prior to the date of application.
- (e) The failure or refusal of the applicant to pay a judgment assessed or awarded by a court of competent jurisdiction that is the result of a violation of this chapter or the Rules and regulations adopted by the board pursuant to this chapter.
- (f) The failure or refusal of the applicant to keep current the insurance required by subdivision (c) of Section 4572.
- (g) The failure or refusal of the applicant to reimburse the department for costs incurred by the department as the result of an action to correct a violation conducted in accordance with Article 8 (commencing with Section 4601).

4574. Term of licenses; denial of renewal.

(a) Timber Operator licenses shall be valid for a period not to exceed two calendar years, as prescribed by the board.

(b) (1) The board may deny an application for license renewal until any violations by the

Z'BERG-NEJEDLY FOREST PRACTICE ACT

applicant that exist on the date of submission of the renewal application, of which the applicant has been notified and given reasonable opportunity to correct, are corrected in accordance with any reasonable terms and conditions required by the board.

(2) The board may issue a temporary license to permit the applicant to perform those Timber Operations that are necessary to correct any violation that has resulted in a denial of license renewal.

(c) For a license first issued on or after January 1, 1997, the board may deny an application for license renewal if the real person in interest has not completed both an education program approved by the director that covers the statutes and regulations governing Timber Operations in this state, and 3,000 hours of work experience in two or more areas of employment in Timber Operations.

4575. Effect of future legislation; transferability.

A license is subject to future legislation and is not transferable.

4576. Suspension or revocation.

A license may be suspended or revoked by the director pursuant to Chapter 5 (commencing with Section 11500) of Part 1 of Division 3 of Title 2 of the Government Code for any of the reasons specified by Section 4573, for refusal to allow inspections, or for violations of any of the Rules and regulations of the board.

4576.1 Period of suspension, revocation, or denial; ownership or other interest in Timber Operations.

During the period for which a Timber Operator license has been suspended, revoked, or denied pursuant to Section 4573 or 4576, the real person in interest, as defined in Section 4570, may not have any ownership, possessory, security, or other pecuniary interest in, or any responsibility for the conduct of, the Timber Operations of any person licensed pursuant to this article. This provision does not preclude ownership of publicly traded stock in any corporation.

4577. Delegation of authority.

The board may delegate its authority under this article to the director.

4578. Forest practices; licenses; exemptions.

Timber Operations, timber harvesting, and any other activities pursuant to a timber harvest plan or a federal or state timber sales contract are exempt from the provisions of Chapter 9 (commencing with Section 7000) of Division 3 of the Business and Professions Code, and no license shall be required for the conduct of Timber Operations on private or public lands, other than as provided in Section 4571.

Article 7. Timber Harvesting.

4581. Necessity of timber harvesting plan.

No person shall conduct Timber Operations unless a timber harvesting plan prepared by a registered professional forester has been submitted for such operations to the department pursuant to this article. Such plan shall be required in addition to the license required in Section 4571.

4582. Contents of timber harvesting plan.

The timber harvesting plan shall be filed with the department in writing by a person who owns, leases, or otherwise controls or operates on all or any portion of any Timberland and who plans to harvest the timber on the timberland. If the person who files the timber harvesting plan is not the owner of the Timberland, the person filing the plan shall notify the Timberland Owner by certified mail that the plan has been submitted and shall certify that mailing to the department. The timber harvesting plan shall be a public record and shall include all of the following information:

Z'BERG-NEJEDLY FOREST PRACTICE ACT

- (a) The name and address of the Timber Owner.
- (b) The name and address of the Timber Operator if known at the time of filing. If the Timber Operator is not known at the time of filing, the plan submitter shall notify the department as soon as the Timber Operator is known, but in any case before Timber Operations begin.
- (c) A description of the land on which the work is proposed to be done, including a United States Geological Survey quadrangle map or equivalent indicating the location of all streams, the location of all proposed and existing logging truck roads, and indicating boundaries of all Site I classification Timberlands to be stocked in accordance with subdivision (b) of Section 4561 and any other site classifications if the board establishes specific minimum stocking standards for other site classifications.
- (d) A description of the silvicultural methods to be applied, including the type of logging equipment to be used.
- (e) An outline of the methods to be used to avoid excessive accelerated erosion from Timber Operations to be conducted within the proximity of a stream.
- (f) Special provisions, if any, to protect any unique area within the area of Timber Operations.
- (g) The expected dates of commencement and completion of Timber Operations.
- (h) A certification by the registered professional forester preparing the plan that the registered professional forester or a designee has personally inspected the plan area.
- (i) Any other information the board provides by regulation to meet its Rules and the standards of this chapter.

4582.3. Notice of intent to harvest timber; adoption of regulations.

The board shall, on or before May 1, 1985, adopt regulations regarding notice of intent to harvest timber, to be given within two working days following submission of a timber harvesting plan, which it determines to be appropriate and which are consistent with law and *Horn v. County of Ventura*, 24 Cal. 3d 605. In adopting the regulations, the board shall take account of the extent of the administrative burden involved in giving the notice. The method of notice shall include, but not be limited to, mailed notice. The regulations may require the person submitting the timber harvesting plan to provide to the department a list of the names and addresses of persons to whom the notice was mailed and a written declaration that the mailing has been completed.

4582.4. Notice of filing to person requesting in writing.

Notice of filing of timber harvesting plans shall be made by the department to any person who requests, in writing, such notification.

4582.5. Applicability of plan to specific property.

Timber harvesting plans shall be applicable to a specific piece of property or properties and shall be based upon such characteristics of the property as vegetation type, soil stability, topography, geology, climate, and stream characteristics.

4582.6. Availability of timber harvesting plan for public inspection; transmittal of copies to agencies; specific comments or recommendations; hearings on plans.

(a) Upon receipt of the timber harvesting plan, the department shall place it, or a true copy of the plan, in a file available for public inspection in the county in which Timber Operations are proposed under the plan, and, for the purpose of interdisciplinary review, shall transmit a copy to the Department of Fish and Wildlife, the appropriate California regional water quality control board, the county planning agency, and, if the area is within its jurisdiction, the Tahoe Regional Planning Agency, as the case may be. The department shall invite, consider, and respond in writing to comments received from public agencies to which the plan has been transmitted and shall consult with those agencies at their request.

(b) Within the public comment period, any responsible agency, as defined in Section 21069, shall provide the department with specific comments or recommendations, or both, on any significant environmental issues and proposed mitigation measures raised by the timber harvesting plan. The

Z'BERG-NEJEDLY FOREST PRACTICE ACT

responsible agency shall also identify its statutory authority for any requests for mitigation measures that it may determine to be necessary. If the responsible agency fails to respond by the end of the public comment period, the department may assume that the responsible agency has no comments or recommendations concerning the timber harvesting plan, but the failure of the responsible agency to make comments or recommendations shall not be used as the basis for a determination or presumption that the timber harvesting plan will have no significant effect on the environment. The department shall consider all comments and recommendations received from responsible agencies and from the public during the public comment period. If a responsible agency fails to respond within the public comment period, it may request additional time to respond. The director may grant an extension of the time to respond of up to 14 calendar days if the director determines, after consultation with the person submitting the timber harvesting plan, that an extension is necessary.

(c) To ensure that all public comments and concerns are considered by the department, each responsible agency shall maintain a list of written information it disseminates on the timber harvesting plan under review prior to the close of the public comment period.

(d) On and after July 1, 1983, the board of supervisors or planning commission of a county for which Rules have been adopted pursuant to Section 4516.5 may request a public hearing on a timber harvesting plan submitted for lands within the county, and the department shall hold a hearing for the purpose of public comment, if requested, prior to taking any action on the timber harvesting plan pursuant to Section 4582.7. The hearing shall be held in the county in which the proposed harvest is located at a time and place convenient to the public. The hearing shall be held in county offices if made available by the county for that purpose. The chairperson of the hearing shall be a representative of the department, shall receive both oral and written testimony from members of the public, local government officials, persons submitting the plans, and others, and shall provide for the hearing to be electronically recorded. The department shall prepare and make available written responses to significant issues raised at the hearing. This subdivision does not extend the time within which an action is required to be taken pursuant to Section 4582.7.

4582.7. Review of plan; public comments; time; hearing; determination by board and director.

(a) The director shall have 30 days from the date that the initial inspection is completed (10 of these days shall follow the date of the final interagency review) or, if the director determines that the inspection need not be made, 15 days from the date of filing, as specified in Section 4604, or a longer period mutually agreed upon by the director and the person submitting the timber harvesting plan, to review the plan and take public comments. After the final review and public comment period has ended, the director shall have up to 15 working days, or a longer period mutually agreed upon by the director and the person submitting the timber harvesting plan, to review the public input, to consider recommendations and mitigation measures of other agencies, to respond in writing to the issues raised, and to determine if the plan is in conformance with the Rules and regulations of the board and with this chapter.

(b) If the director determines that the timber harvesting plan is not in conformance with the Rules and regulations of the board or with this chapter, the director shall return the plan, stating the director's reasons in writing, and advising the person submitting the plan of the person's right to a hearing before the board, and Timber Operations may not commence.

(c) A person to whom a timber harvesting plan is returned may, within 10 days from the date of receipt of the plan, request of the board a public hearing before the board. The board shall schedule a public hearing to review the timber harvesting plan to determine if the plan is in conformance with the Rules and regulations of the board and with this chapter. Timber Operations shall await board approval of the timber harvesting plan. Board action shall occur within 30 days from the date of the filing of the appeal, or a longer period mutually agreed upon by the board and the person filing the appeal.

(d) If the timber harvesting plan is not approved on appeal to the board, the plan may be found to be in conformance by the director within 10 days from the date of the board action, provided that the plan is brought into full conformance with the Rules and regulations of the board and with this chapter. If the director does not act within 25 days or a longer period mutually agreed upon by the

Z'BERG-NEJEDLY FOREST PRACTICE ACT

director and the person submitting the timber harvesting plan, Timber Operations may commence pursuant to the plan, and all provisions of the plan shall be followed as provided in this chapter.

(e) Upon the request of a responsible agency, the director shall consult with that agency, pursuant to this chapter, but the director, or the director's designee within the department, shall have the final authority to determine whether a timber harvesting plan is in conformance with the Rules and regulations of the board and with this chapter for purposes of approval by the department.

4582.71. Findings by a regional water quality control board under which a timber harvesting plan may not be approved; discharge into a impaired Watercourse; delegation of board authority; notice of finding; role of director.

(a) A timber harvesting plan may not be approved if the appropriate regional water quality control board finds, based on substantial evidence, that the Timber Operations proposed in the plan will result in a discharge into a Watercourse that has been classified as impaired due to sediment pursuant to subsection (d) of Section 303 of the Federal Water Pollution Control Act, that causes or contributes, to a violation of the regional water quality control plan.

(b) The exercise of a regional water quality control board's authority pursuant to subdivision (a) may be delegated to the executive officer of that regional water quality control board as long as the executive officer's determination is subject to review by that regional water quality control board upon request of the person that has submitted the timber harvesting plan or upon motion of that regional water quality control board.

(c) If the appropriate regional water quality control board makes a finding pursuant to subdivision (a), the executive officer of that regional water quality control board shall, before the close of the public comment period under Section 4582.7, notify the director in writing of the finding and advise the director that the plan may not be approved. If the issues that lead to a regional water quality control board's finding pursuant to subdivision (a) cannot be resolved during the director's determination period under Section 4582.7 or a longer period that is mutually agreeable to the director and the person that submitted the timber harvesting plan, the director shall deny the timber harvesting plan and return the plan to the person that submitted it. The director shall advise the person that submitted the timber harvesting plan of the reasons why the plan is being returned.

4582.75. Rules and provisions of this chapter as criteria for reviewing timber harvesting plans.

The Rules adopted by the board and the provisions of this chapter shall be the only criteria employed by the director when reviewing timber harvesting plans pursuant to Section 4582.7.

4582.8. Transmittal of plans to Board of Equalization.

Within 10 days from the date that a timber harvesting plan is determined to be in conformance under Section 4582.7, or within 10 days from the date of receipt of a notice of Timber Operations, a nonindustrial timber harvest notice, a notice of exemption to convert less than three acres to a non-timber use pursuant to Section 4584, or an emergency notice filed pursuant to Section 4592, the director shall transmit copies thereof to the State Board of Equalization. Any notice of exemption or notice of emergency transmitted to the State Board of Equalization pursuant to this section shall include, among other things, an estimate of the Timber Owner as to whether the timber to be harvested pursuant to the notice will or will not be exempt from timber yield tax pursuant to Section 38116 of the Revenue and Taxation Code as interpreted and implemented by the State Board of Equalization.

4582.9. Appeal of approved plan; conditions of filing; suspension of Timber Operations; hearing.

(a) Notwithstanding any other provision of this chapter, the Director of Fish and Game or the State Water Resources Control Board may, not later than 10 days after approval of a plan by the director, appeal the approval to the board. At the time of filing of an appeal with the board, the person shall notify the director and the plan submitter of the appeal, and no further Timber

Z'BERG-NEJEDLY FOREST PRACTICE ACT

Operations shall occur under the plan until the final determination of the appeal by the board.

(b) The Director of Fish and Game or the State Water Resources Control Board may appeal the approval of a plan by the director only if the Department of Fish and Game or the State Water Resources Control Board or a California regional water quality control board has:

(1) Participated in an onsite inspection of the plan with the department; and

(2) Participated in a multidisciplinary review of the plan. The board may establish procedures for filing an appeal and may, in order to demonstrate that a substantial issue is raised with respect to the environment or public safety, specify findings which are required to be made in filing an appeal.

(c) The board shall grant a hearing if it determines that the appeal under this section raises substantial issues with respect to the environment or to public safety. The board, by regulation, may delegate this determination to its chairperson.

(d) The board shall hold a public hearing within 30 days after the filing of an appeal, or a longer period mutually agreed upon by the board, the appellant, and the plan submitter. Witnesses may appear either at the request of a party having standing or at a request of a majority of the board or board committee holding the hearing. Within 10 days after the conclusion of the hearing, the board shall approve or deny the plan. The basis for the board's decision shall be all applicable provisions of California law, including, but not limited to, the California Timberland Productivity Act of 1982 (Chapter 6.7 (commencing with Section 51100) of Division 1 of Title 5 of the Government Code) and subdivision (d) of Section 4512. In denying a plan, the board may make findings that set forth conditions under which it believes the plan would have been approved. The board may delegate conduct of the hearing and the decision to a committee of three members to be appointed for that hearing by the chairperson of the board. The committee shall consist of one general public member, one industry member, and the chairperson or the chairperson's designee. The chairperson of the board or the chairperson's designee shall conduct the hearing. The decision of the committee shall have the full force of a decision of the full board. At any time prior to a decision on an appeal conducted by a committee, any member of the committee may file a declaration of importance with the executive officer of the board and that appeal shall be immediately transferred to the full board for decision.

4583. Standards and Rules; conformance of plan; changes or modifications; exceptions.

A timber harvesting plan shall conform to all standards and Rules which are in effect at the time the plan becomes effective. Except for stocking standards in effect at the time of commencement of Timber Operations under a timber harvesting plan, which shall remain in effect for any Timberland harvested under such plan, all Timber Operations shall conform to any changes or modifications of standards and Rules made thereafter unless prior to the adoption of such changes or modifications, substantial liabilities for Timber Operations have been incurred in good faith and in reliance upon the standards in effect at the time the plan became effective and the adherence to such new Rules or modifications would cause unreasonable additional expense to the owner or operator.

4583.2. Report of deviations in plan which threaten attainment of standards or regulations.

The registered professional forester who prepared the timber harvesting plan and or any other registered professional forester who is employed by the owner or operator, shall report to the owner and operator if there are deviations of any sort from the plan that in the forester's judgment threaten the attainment of the resource conservation standards or other regulations promulgated pursuant to this chapter.

4583.5. Disciplinary action for material misstatement in filing of plan or report.

If the board finds that the registered professional forester has made a material misstatement in the filing of a timber harvesting plan or report pursuant to this chapter, it shall take disciplinary action against the forester as provided under Section 775.

4584. Exempt Activities.

Z'BERG-NEJEDLY FOREST PRACTICE ACT

Upon determining that this exemption is consistent with the purposes of this chapter, the board may exempt from this chapter, or portions of this chapter, a person engaged in forest management whose activities are limited to any of the following:

- (a) The cutting or removal of trees for the purpose of constructing or maintaining a right-of-way for utility lines.
- (b) The planting, growing, nurturing, shaping, shearing, removal, or harvest of immature trees for Christmas trees or other ornamental purposes or minor forest products, including fuelwood.
- (c) The cutting or removal of dead, dying, or diseased trees of any size.
- (d) Site Preparation.
- (e) Maintenance of drainage facilities and soil stabilization treatments.
- (f) Timber Operations on land managed by the Department of Parks and Recreation.
- (g) **(1)** The one-time conversion of less than three acres to a non-timber use. A person, whether acting as an individual, as a member of a partnership, or as an officer or employee of a corporation or other legal entity, shall not obtain more than one exemption pursuant to this subdivision in a five-year period. If a partnership has as a member, or if a corporation or other legal entity has as an officer or employee, a person who has received this exemption within the past five years, whether as an individual, as a member of a partnership, or as an officer or employee of a corporation or other legal entity, then that partnership, corporation, or other legal entity is not eligible for this exemption. "Person," for purposes of this subdivision, means an individual, partnership, corporation, or other legal entity.

(2) (A) Notwithstanding Section 4554.5, the board shall adopt regulations that do all of the following:

(i) Identify the required documentation of a bona fide intent to complete the conversion that an applicant will need to submit in order to be eligible for the exemption in paragraph (1).

(ii) Authorize the department to inspect the sites approved in conversion applications that have been approved on or after January 1, 2002, in order to determine that the conversion was completed within the two-year period described in subparagraph (B) of paragraph (2) of subdivision (a) of Section 1104.1 of Title 14 of the California Code of Regulations.

(iii) Require the exemption pursuant to this subdivision to expire if there is a change in Timberland ownership. The person who originally submitted an application for an exemption pursuant to this subdivision shall notify the department of a change in Timberland ownership on or before five calendar days after a change in ownership.

(iv) The board may adopt regulations allowing a waiver of the five-year limitation described in paragraph (1) upon finding that the imposition of the five-year limitation would impose an undue hardship on the applicant for the exemption. The board may adopt a process for an appeal of a denial of a waiver.

(v) The board may adopt regulations allowing a waiver of the one-time limitation described in paragraph (1) upon finding that the imposition of the one-time limitation would impose an undue hardship on the applicant. The board may adopt a process for an appeal of a denial of a waiver.

(B) The application form for the exemption pursuant to paragraph (1) shall prominently advise the public that a violation of the conversion exemption, including a conversion applied for in the name of someone other than the person or entity implementing the conversion in bona fide good faith, is a violation of this chapter and penalties may accrue up to ten thousand dollars (\$10,000) for each violation pursuant to Article 8 (commencing with Section 4601).

(h) An easement granted by a right-of-way construction agreement administered by the federal government if timber sales and operations within or affecting the area are reviewed and conducted pursuant to the National Environmental Policy Act of 1969 (42 U.S.C. Sec. 4321 et seq.).

(i) (1) The cutting or removal of trees in compliance with Sections 4290 and 4291 that eliminates the vertical continuity of vegetative fuels and the horizontal continuity of tree crowns for the purpose of reducing flammable materials and maintaining a fuel break for a distance of not more than 150 feet on each side from an approved and legally permitted structure that complies with the

Z'BERG-NEJEDLY FOREST PRACTICE ACT

California Building Standards Code, when that cutting or removal is conducted in compliance with this subdivision. For purposes of this subdivision, an “approved and legally permitted structure” includes only structures that are designed for human occupancy, garages, barns, stables, and structures used to enclose fuel tanks.

(2) **(A)** The cutting or removal of trees pursuant to this subdivision is limited to cutting or removal that will result in a reduction in the rate of fire spread, fire duration and intensity, fuel ignitability, or ignition of the tree crowns and shall be in accordance with any regulations adopted by the board pursuant to this section.

(B) Trees shall not be cut or removed pursuant to this subdivision by the clearcutting regeneration method, by the seed tree removal step of the seed tree regeneration method, or by the shelterwood removal step of the shelterwood regeneration method.

(3) **(A)** All fuel treatments conducted pursuant to this subdivision that do not comply with board rules and regulations may be determined to be a nuisance and subject to abatement by the department or the city or county having jurisdiction.

(B) The costs incurred by the department, city, or county, as the case may be, to abate the nuisance upon a parcel of land subject to the Timber Operations, including, but not limited to, investigation, boundary determination, measurement, and other related costs, may be recovered by special assessment and lien against the parcel of land by the department, city, or county. The assessment may be collected at the same time and in the same manner as ordinary ad valorem taxes, and shall be subject to the same penalties and the same procedure and sale in case of delinquency as is provided for ad valorem taxes.

(4) All Timber Operations conducted pursuant to this subdivision shall conform to applicable city or county general plans, city or county implementing ordinances, and city or county zoning ordinances. This paragraph does not authorize the cutting, removal, or sale of timber or other solid wood forest products within an area where timber harvesting is prohibited or otherwise restricted pursuant to the rules or regulations adopted by the board.

(5) **(A)** The board shall adopt regulations, initially as emergency regulations in accordance with subparagraph (B), that the board considers necessary to implement and to obtain compliance with this subdivision.

(B) The emergency regulations adopted pursuant to subparagraph (A) shall be adopted in accordance with the Administrative Procedure Act (Chapter 3.5 (commencing with Section 11340) of Part 1 of Division 3 of Title 2 of the Government Code). The adoption of emergency regulations shall be deemed to be an emergency and necessary for the immediate preservation of the public peace, health, and safety, or general welfare.

(j) **(1)** The cutting or removal of trees on the person’s property that eliminates the vertical continuity of vegetative fuels and the horizontal continuity of tree crowns for the purpose of reducing flammable materials and maintaining a fuel break. An exemption pursuant to this subdivision shall be known as the Small Timberland Owner Exemption. The cutting or removal of trees in compliance with this subdivision shall be subject to all of the following conditions:

(A) The notice of exemption is prepared, signed, and submitted by a registered professional forester to the department.

(B) The residual stocking standards are consistent with the following standards and shall be achieved through uneven-aged management, as defined in Section 895.1 of Title 14 of the California Code of Regulations excluding group selection:

(i) On Site I lands at least 150 square feet of basal area shall be retained within the coast forest district, as defined in Section 907 of Title 14 of the California Code of Regulations, while at least 100 square feet of basal area shall be retained within the northern and southern districts, as defined in Section 908 or 909, respectively, of Title 14 of the California Code of Regulations.

(ii) On Site II lands at least 100 square feet of basal area shall be retained within the coast district, while at least 75 square feet of basal area shall be retained within the northern and southern districts.

(iii) On Site III lands at least 75 square feet of basal area shall be retained.

Z'BERG-NEJEDLY FOREST PRACTICE ACT

(C) (i) Forest management activities will increase the quadratic mean diameter of the stand.

(ii) Increases in quadratic mean diameter shall only consider trees greater than eight inches in diameter at breast height. The registered professional forester responsible for preparation of the notice of exemption shall report the expected postharvest increase in quadratic mean diameter.

(D) (i) The residual stand consists primarily of healthy and vigorous dominant and codominant trees from the preharvest stand, well distributed through the harvested area.

(ii) No trees of the genus quercus that are greater than 26 inches diameter at stump height, measured 8 inches above ground level, shall be harvested under a notice of exemption submitted pursuant to this subdivision.

(iii) No trees greater than 32 inches diameter at stump height, measured 8 inches above ground level, shall be harvested under a notice of exemption submitted pursuant to this subdivision.

(iv) The six largest trees per acre within the boundaries of a notice of exemption submitted pursuant to this subdivision shall not be harvested.

(v) The postharvest composition of tree species shall be representative of the preharvest stand condition and demonstrate progression towards climax forest conditions, unless the registered professional forester provides justification explaining how modification of species diversity will benefit forest health and resiliency.

(E) The submitted notice of exemption shall include a description of the preharvest stand structure and a statement of the minimum expected postharvest stocking.

(F) All trees that are harvested or all trees that are retained shall be marked by, or under the supervision of, a registered professional forester before felling operations begin.

(G) The board shall adopt regulations for the treatment of understory vegetation and standing dead fuels, canopy closure, clearance to base of live crown, or ladder fuels, that could promote the spread of wildfire. A fuel reduction effort conducted under a submitted notice of exemption pursuant to this subdivision shall comply with the canopy closure regulations adopted by the board on June 10, 2004, and as those regulations may be amended.

(H) A notice of exemption submitted to the department that is within the coast forest district is submitted for a small forestland owner who owns 60 acres or less of timberland within a single planning watershed.

(I) A notice of exemption submitted to the department that is within the northern forest district or the southern forest district is submitted for a small forestland owner who owns 100 acres or less of timberland within a single planning watershed.

(2) (A) All Timber Operations conducted pursuant to this subdivision may only occur once on any given acre per any 10-year period of time. The department shall only grant a maximum of three exemptions under the Small Timberland Owner Exemption per landowner.

(B) Except for the harvesting of dead, diseased, or dying trees, during this 10-year period the department shall not approve a plan, as defined in Section 895.1 of Title 14 of the California Code of Regulations, that allows even-aged silviculture prescriptions. During this 10-year period of time a registered professional forester shall not submit a notice of exemption pursuant to subdivision (k) on portions of the property subject to an exemption pursuant to this subdivision.

(3) The department may conduct an onsite inspection to determine compliance with this subdivision. The department may notify the Regional Water Quality Control Board, the Department of Fish and Wildlife, and the California Geologic Survey prior to conducting the onsite inspection. The Regional Water Quality Control Board, the Department of Fish and Wildlife, and the California Geologic Survey may conduct an inspection with the department.

(4) (A) This subdivision shall be operative for a period of five years after the effective date of emergency regulations as adopted by the board and as of that date is inoperative.

(B) The board shall notify the Secretary of State when emergency regulations have been adopted.

(k) (1) The harvesting of trees, limited to those trees that eliminate the vertical continuity of

Z'BERG-NEJEDLY FOREST PRACTICE ACT

vegetative fuels and the horizontal continuity of tree crowns, for the purpose of reducing the rate of fire spread, duration and intensity, fuel ignitability, or ignition of tree crowns. An exemption pursuant to this paragraph shall be known as the Forest Fire Prevention Exemption.

(2) The board may authorize an exemption pursuant to paragraph (1) only if the tree harvesting will decrease fuel continuity and increase the quadratic mean diameter of the stand, and the tree harvesting area will not exceed 300 acres. Increases in quadratic mean diameter shall only consider trees greater than eight inches in diameter at breast height. The notice of exemption may be authorized only if all of the conditions specified in paragraphs (3) to (9), inclusive, are met.

(3) A registered professional forester shall prepare the notice of exemption and submit it to the director.

(4) (A) The submitted notice of exemption shall include a description of the preharvest stand structure and a statement of the postharvest stand stocking levels and the expected postharvest increase in quadratic mean diameter.

(B) The level of residual stocking shall be consistent with maximum sustained production of high-quality timber products. The residual stand shall consist primarily of healthy and vigorous dominant and codominant trees from the preharvest stand. Stocking shall not be reduced below the standards required by the following provisions that apply to the exemption at issue:

(i) Clauses 1 to 4, inclusive, of subparagraph (A) of paragraph (1) of subdivision (a) of Sections 913.3, 933.3, and 953.3 of Title 14 of the California Code of Regulations, where appropriate.

(C) If the preharvest dominant and codominant crown canopy is occupied by trees less than 14 inches in diameter at breast height, a minimum of 100 trees over four inches in diameter at breast height shall be retained per acre for Site I, II, and III lands, and a minimum of 75 trees over four inches in diameter at breast height shall be retained per acre for Site IV and V lands.

(D) All trees that are harvested or all trees that are retained shall be marked or sample marked by, or under the supervision of, a registered professional forester before felling operations begin. The board shall adopt regulations for sample marking for this section in Title 14 of the California Code of Regulations. Sample marking shall be limited to homogenous forest stand conditions typical of plantations.

(5) (A) The board shall adopt regulations for the treatment of understory vegetation and standing dead fuels, canopy closure, clearance to base of live crown, or ladder fuels, that could promote the spread of wildfire. A fuel reduction effort conducted under a submitted notice of exemption pursuant to this subdivision shall comply with the canopy closure regulations adopted by the board on June 10, 2004, and as those regulations may be amended.

(B) The postharvest stand shall not contain more than 200 trees over three inches in diameter per acre.

(C) Vertical spacing shall be achieved by treating dead fuels to a minimum clearance distance of eight feet measured from the base of the live crown of the postharvest dominant and codominant trees to the top of the dead surface fuels.

(D) The standards required by subparagraphs (A) to (C), inclusive, shall be achieved on approximately 80 percent of the treated area.

(6) Prior to submission of a notice of exemption to the department, the registered professional forester responsible for submitting the notice shall designate temporary road locations, landing locations, tractor road crossings of class III watercourses, unstable areas, or connected headwall swales on the ground and map their locations.

(7) The construction or reconstruction of temporary roads on slopes of 30 percent or less shall be allowed if all of the following conditions are met:

(A) Temporary roads or landings shall not be located on unstable areas, as defined in Section 895.1 of Title 14 of the California Code of Regulations.

(B) Temporary roads shall be single-lane in width.

(C) Temporary roads shall not be located across a connected headwall swale, as defined in Section 895.1 of Title 14 of the California Code of Regulations.

(D) Construction or reconstruction of temporary roads, landings, or watercourse

Z'BERG-NEJEDLY FOREST PRACTICE ACT

crossings shall not occur during the winter operating period. Pursuant to subdivision (g) of Sections 923.6, 943.6, and 963.6, as applicable, of Title 14 of the California Code of Regulations, roads and landings used for log hauling or other heavy equipment uses during the winter period shall occur on a stable operating surface and, where necessary, be surfaced with rock to a depth and quantity sufficient to maintain the stable operating surface. Use shall be prohibited on roads that are not hydrologically disconnected and exhibit saturated soil conditions. Timber Operations during the winter period shall comply with paragraphs (1) and (2) of subdivision (c) of Sections 914.7, 934.7, and 954.7, as applicable, of Title 14 of the California Code of Regulations.

(E) Use of temporary roads shall comply with the operational provisions of Article 12 (commencing with Section 923) of Title 14 of the California Code of Regulations, and recognize guidance on hydrologic disconnection in Technical Rule Addendum Number 5.

(F) No logging road or landings construction or reconstruction activities of any kind shall occur within 200 feet of class I and class II watercourses or within 50 feet of a class III watercourses.

(G) The landowner shall retain a registered professional forester who is available to provide professional advice to the licensed timber operator and timberland owner throughout the active Timber Operations. The name, address, telephone number, and registration number of the retained registered professional forester shall be provided on the submitted notice of exemption. This professional advice shall include overseeing the construction or reconstruction of any temporary roads or landings and advising on necessary mitigation to avoid potential Impacts to associated watershed and forest resources. The registered professional forester shall also comply with Section 1035.2 of Title 14 of the California Code of Regulations, relating to interaction between the licensed timber operator and the registered professional forester.

(H) The registered professional forester responsible for submitting the notice of exemption shall affirm that the construction or reconstruction of each temporary road is necessary to provide access to harvest areas where no feasible alternative exists. The submitted notice of exemption shall include the number and cumulative length of temporary roads that will be constructed or Reconstructed.

(I) **(i)** Temporary road construction or reconstruction, shall be limited to no more than two miles of road per ownership in a planning watershed per any five-year period.

(ii) For each exemption affecting less than 40 acres, all temporary roads constructed or Reconstructed under this exemption shall not exceed a cumulative length of 300 feet.

(iii) For each exemption affecting between 40 and 80 acres, all temporary roads constructed or Reconstructed under this exemption shall not exceed a cumulative length of between 300 and 600 feet, as determined on a pro rata basis by the total acreage affected by the exemption.

(iv) For each exemption affecting over 80 acres, all temporary roads constructed or Reconstructed under the exemption shall not exceed a cumulative length of 600 feet. The submitted notice of exemption shall list the number of acres affected and the cumulative length of the road in feet.

(v) Temporary roads constructed or Reconstructed under this exemption shall not be connected to other temporary roads constructed under previous or subsequent exemptions filed under this paragraph.

(vi) All temporary roads shall be abandoned using proactive measures that have been applied to effectively remove them from the permanent road network, in accordance with the definition of Abandoned Road as defined in Section 895.1 of Title 14 of the California Code of Regulations.

(vii) This paragraph shall not be interpreted to permit road construction or reconstruction except as authorized under the Forest Fire Prevention Exemption, pursuant to this paragraph.

(viii) No trees larger than 36 inches in diameter at stump height, measured 8 inches above ground level, shall be removed for the purposes of road construction or reconstruction under a notice of exemption submitted pursuant to this subdivision. A tree that is between 30 and 36

Z'BERG-NEJEDLY FOREST PRACTICE ACT

inches in diameter at stump height, measured 8 inches above ground level, may be removed for the purposes of road construction or reconstruction under a notice of exemption submitted pursuant to this subdivision only if there are no feasible alternatives for the road placement.

(8) Except within constructed or Reconstructed temporary road prisms, only trees less than 30 inches in stump diameter, measured at eight inches above ground level, may be removed.

(9) All Timber Operations conducted pursuant to this subdivision shall only occur within the most recent version of the department's Fire Hazard Severity Zone Map in the moderate, high, and very high fire threat zones.

(10) If pesticides or herbicides will be used within the boundaries of an area covered by a notice of exemption pursuant to this paragraph within one year of director acceptance, the timberland owner shall notify the appropriate regional water quality control board 10 days prior to application of any pesticides or herbicides.

(11) After the Timber Operations are complete, the department shall conduct an onsite inspection to determine compliance with this subdivision and whether appropriate enforcement action should be initiated. The department shall notify the appropriate Regional Water Quality Control Board, the Department of Fish and Wildlife, and the California Geologic Survey seven days prior to conducting the onsite inspection. The Regional Water Quality Control Board, the Department of Fish and Wildlife, and the California Geologic Survey may conduct an inspection with the department.

(12) This subdivision shall become inoperative on January 1, 2026.

(l) The cutting or removal of trees to restore and conserve California black or Oregon white oak woodlands and associated grasslands, if all of the following requirements are met:

(1) A registered professional forester shall prepare the notice of exemption and submit it to the director. The notice shall include all of the following:

(A) A certification signed by the registered professional forester that a minimum of 35 square feet of basal area per acre of California black or Oregon white oak, or both, occupy the proposed treatment area at the time the notice is prepared and the timber operation is designed to restore and conserve California black and Oregon white oak woodlands and associated grasslands.

(B) A description of the preharvest stand structure and a statement of the postharvest stand stocking levels.

(2) No tree larger than 26 inches in diameter at stump height shall be harvested for commercial purposes, which includes use for saw logs, posts and poles, fuel wood, biomass, or other forest products.

(3) Only conifers within 300 feet of a California black or Oregon white oak that are at minimum four inches in diameter at breast height may be harvested.

(4) The total area exempted pursuant to this subdivision shall not exceed 300 acres per property per five-year period.

(5) Conifer shall be reduced to less than 25 percent of the combined hardwood and conifer postharvest stand stocking levels.

(6) No more than 20 percent of the total basal area of preexisting oak stock shall be cut or removed during harvest and a minimum of 35 square feet of basal area per acre of California black or Oregon white oak, or both, shall be maintained postharvest.

(7) Slash shall be configured so as to minimize the risk of fire mortality to the remaining oak trees.

(8) The board shall adopt regulations to implement this subdivision.

(9) This subdivision shall not apply to the Southern Subdistrict of the Coast Forest District, as defined in Section 895.1 of Title 14 of the California Code of Regulations, or the Southern Forest District, as defined in Section 909 of Title 14 of the California Code of Regulations.

(m) (1) The board may exempt from this chapter, or portions of this chapter, a person engaged in forest management whose activities are limited to the cutting or removal of trees on the person's property in compliance with Sections 4290 and 4291 that eliminates the vertical continuity of vegetative fuels and the horizontal continuity of tree crowns for the purpose of reducing flammable materials and maintaining a fuelbreak for a distance of not more than 300 feet on each side from an

Z'BERG-NEJEDLY FOREST PRACTICE ACT

approved and legally permitted habitable structure, when that cutting or removal is conducted in compliance with this subdivision and all of the following conditions are met:

(A) The notice of exemption is prepared, signed, and submitted by a registered professional forester to the department.

(B) For the areas between 150 and 300 feet from the habitable structure, the operations meet all of the following provisions:

(i) The residual stocking standards are consistent with Sections 913.2, 933.2, and 953.2 of Title 14 of the California Code of Regulations, as appropriate.

(ii) Activities within this area will increase the quadratic mean diameter of the stand.

(iii) The residual stand consists primarily of healthy and vigorous dominant and codominant trees from the preharvest stand, well distributed throughout the harvested area.

(iv) Postharvest slash treatment and stand conditions will lead to more moderate fire behavior in the professional judgment of the registered professional forester who submits the notice of exemption.

(v) Any additional guidance for slash treatment and postharvest stand conditions and any other issues deemed necessary that are consistent with this section, as established by the board.

(2) For purposes of this subdivision, "habitable structure" means a building that contains one or more dwelling units or that can be occupied for residential use. Buildings occupied for residential use include single-family homes, multidwelling structures, mobile and manufactured homes, and condominiums. For purposes of this subdivision, "habitable structure" does not include commercial, industrial, or incidental buildings such as detached garages, barns, outdoor sanitation facilities, and sheds.

(3) This subdivision shall become inoperative on January 1, 2026.

4584.1. Exempt Conditions

Rules and regulations adopted by the board pursuant to Section 4584, except subdivision (k) of Section 4584, shall comply with the following standards, as determined appropriate and necessary by the board:

(a) Notices of exemption that are prepared and submitted to the director shall include a map of the area of operations that complies with the requirements of paragraphs (1), (3), and (4), subparagraphs (A), (B), (D), and (E) of paragraph (5), paragraphs (7) to (12), inclusive, and paragraph (14) of subdivision (x) of Section 1034 of Title 14 of the California Code of Regulations.

(b) Notices of exemption that are prepared and submitted to the director shall provide a confidential that includes all the information required by paragraphs (2) and (7) to (11), inclusive, of subdivision (c) of Sections 929.1, 949.1 and 969.1, as applicable, of Title 14 of the California Code of Regulations, and site records if required pursuant to subdivision (g) of that section or pursuant to Section 929.5 of Title 14 of the California Code of Regulations. This subdivision shall not apply to activities described in subdivision (i) or (m) of Section 4584.

(c) All fuel treatments required by the board shall be completed within one year from the date the director receives the notice, with the exception of burning. This shall include treatment of surface fuels, wood debris, and slash, which shall be lopped, removed, chipped, piled for burning, or otherwise treated. Burning shall be completed within two years from the date the director receives the notice of exemption.

(d) Slash and woody debris shall be treated to achieve a maximum post harvest depth of 18 inches above the ground except within 150 feet from any point of an approved and legally permitted structure that complies with the California Building Code. Surface fuels, slash, and woody debris within 150 feet from any point of an approved and legally permitted structure that complies with the California Building Code shall be chipped, piled and burned, or removed.

(e) Timber Operations shall comply with the requirements of paragraphs (1) to (10), inclusive, of subdivision (b) of Section 1038 of Title 14 of the California Code of Regulations.

Z'BERG-NEJEDLY FOREST PRACTICE ACT

(f) All Timber Operations conducted in Lake Tahoe Region must have a valid Tahoe Basin Tree Removal Permit, as defined by the Tahoe Regional Planning Agency (TRPA), or shall be conducted under a valid TRPA Memorandum of Understanding, when such a permit is required by TRPA.

(g) The submitted notice of exemption shall include selection criteria for the trees to be harvested or the trees to be retained.

(h) The department shall provide the appropriate regional water quality control board, the Department of Fish and Wildlife, and the California Geologic Survey with copies of notices of exemption when they are submitted.

(i) The submitted notice of exemption shall include the tentative commencement date of Timber Operations.

(j) Within a 15-day period, the registered professional forester or person responsible for the submittal of the notice of exemption shall notify the department, the Department of Fish and Game, the appropriate regional water quality control board, and the California Geologic Survey of the actual date of commencement of Timber Operations.

(k) Timber Operations pursuant to an exemption may not commence for 10 working days from the date of the director's receipt of the notice of exemption unless this delay is waived by the director. The director shall determine whether the notice of exemption is complete, and if so, shall send a copy of a notice of acceptance to the submitter. If the notice of exemption is not complete and accurate, it shall be returned to the submitter and the timber operator may not proceed. If the director does not act within 10 days of receipt of the notice of exemption, Timber Operations may commence.

(l) **(1)** No large old trees, defined as a tree that existed before 1800 AD or is greater than 60 inches in diameter at stump height for Sierra or Coast Redwoods, and 48 inches in diameter at stump height for all other tree species or Decadent and Deformed Trees with Value to Wildlife, as defined in Section 895.1 of Title 14 of the California Code of Regulations, shall be harvested unless the following apply:

(A) The tree is not critical for the maintenance of a Late Successional Stand.

(B) A registered professional forester attached to the submitted notice of exemption a written explanation and justification for the harvest of the tree based on the registered professional forester's finding of any of the following:

(i) The tree is a hazard to safety or property.

(ii) The removal of the tree is necessary for the construction of a building as approved by the appropriate local jurisdiction and shown on the county or city approved site plan, which shall be attached to the submitted notice of exemption.

(iii) The tree is dead or likely to die within one year of the date of the proposed removal, as determined by a registered professional forester.

(2) A registered professional forester-written explanation or justification need not be attached to the submitted notice of exemption if an approved Habitat Conservation Plan, Sustained Yield Plan, or plan, as that term is as defined in Section 895.1 of Title 14 of the California Code of Regulations addresses large old tree retention for the area in which the large old tree is proposed for removal and the removal is in compliance with the retention standards of that document.

(3) Any tree harvested pursuant to this subdivision shall be shown on a map provided with the submitted notice of exemption to the department.

(4) This subdivision shall not apply to or be used in conjunction with either the Small Timberland Owner Exemption created pursuant to subdivision (j) of Section 4584 or with the Forest Fires Prevention Exemption created pursuant to subdivision (k) of Section 4584.

(m) Helicopter yarding shall be prohibited.

(n) All applicable provisions of the Professional Foresters Law, including, but not limited to, Sections 775 to 779, inclusive, of this code, as well as all applicable provisions of Registration of Professional Forester Rules, including, but not limited to, Sections 1612 to 1614, inclusive, of Title 14 of the California Code of Regulations, shall apply to the practice of professional forestry as it relates to this section.

Z'BERG-NEJEDLY FOREST PRACTICE ACT

4584.2. Exempt Forest Fire Prevention

Rules and regulations adopted by the board pursuant to subdivision (k) of Section 4584, shall comply with the following standards:

(a) Notices of exemption that are prepared and submitted to the director shall include a map of the area of operations that complies with the requirements of paragraphs (1), (3), and (4), subparagraphs (A), (B), (D), and (E) of paragraph (5), paragraphs (7) to (12), inclusive, and paragraph (14) of subdivision (x) of Section 1034 of Title 14 of the California Code of Regulations.

(b) Notices of exemption that are prepared and submitted to the director shall provide a confidential archaeological letter that includes all the information required by paragraphs (2) and (7) to (11), inclusive, of subdivision (c) of Sections 929.1, 949.1 and 969.1, as applicable, of Title 14 of the California Code of Regulations, and site records if required pursuant to subdivision (g) of that section or pursuant to Section 929.5 of Title 14 of the California Code of Regulations.

(c) All fuel treatments required by the board shall be completed within one year from the date the director receives the notice, with the exception of burning. This shall include treatment of surface fuels, wood debris, and slash, which shall be lopped, removed, chipped, piled for burning, or otherwise treated. Burning shall be completed within two years from the date the director receives the notice of exemption.

(d) Slash and woody debris shall be treated to achieve a maximum post harvest depth of 18 inches above the ground except within 150 feet from any point of an approved and legally permitted structure that complies with the California Building Code. Surface fuels, slash, and woody debris within 150 feet from any point of an approved and legally permitted structure that complies with the California Building Code shall be chipped, burned, or removed.

(e) Timber Operations shall comply with the requirements of paragraphs (1) to (4), inclusive, and (6) to (10), inclusive, of subdivision (b) of Section 1038 of Title 14 of the California Code of Regulations.

(f) All Timber Operations conducted in Lake Tahoe Region must have a valid Tahoe Basin Tree Removal Permit, as defined by the Tahoe Regional Planning Agency (TRPA), or shall be conducted under a valid TRPA Memorandum of Understanding, when such a permit is required by TRPA.

(g) The submitted notice of exemption shall include selection criteria for the trees to be harvested or the trees to be retained.

(h) The department shall provide the appropriate regional water quality control board, the Department of Fish and Wildlife, and the California Geologic Survey with copies of notices of exemption when they are submitted.

(i) The submitted notice of exemption shall include the tentative commencement date of Timber Operations.

(j) Within a 15-day period, the registered professional forester responsible for the submittal of the notice of exemption shall notify the department, the Department of Fish and Game, the appropriate regional water quality control board, and the California Geologic Survey of the actual date of commencement of Timber Operations.

(k) Operations pursuant to an exemption may not commence for 10 working days from the date of the director's receipt of the notice of exemption unless this delay is waived by the director. The director shall determine whether the notice of exemption is complete, and if so, shall send a copy of a notice of acceptance to the submitter. If the notice of exemption is not complete and accurate, it shall be returned to the submitter and the timber operator may not proceed. If the director does not act within five days of receipt of the notice of exemption, Timber Operations may commence.

(l) (1) No Decadent and Deformed Trees with Value to Wildlife, as defined in Section 895.1 of Title 14 of the California Code of Regulations, shall be harvested unless all the following apply:

(A) The tree is not critical for the maintenance of a Late Successional Stand.

(B) A registered professional forester attached to the submitted notice of exemption a written explanation and justification for the harvest of the tree based on the registered professional forester's finding of any of the following:

(i) The tree is a hazard to safety or property.

(ii) The removal of the tree is necessary for the construction of a building as

Z'BERG-NEJEDLY FOREST PRACTICE ACT

approved by the appropriate local jurisdiction and shown on the county or city approved site plan which shall be attached to the submitted notice of exemption.

(iii) The tree is dead or likely to die within one year of the date of the proposed removal, as determined by a registered professional forester.

(2) A registered professional forester's written explanation or justification need not be attached to the submitted notice of exemption if an approved Habitat Conservation Plan, Sustained Yield Plan, or plan as that term is defined in Section 895.1 of Title 14 of the California Code of Regulations addresses large old tree retention for the area in which the large old tree is proposed for removal and the removal is in compliance with the retention standards of that document.

(3) Any tree harvested pursuant to this subdivision shall be shown on a map provided with the submitted notice of exemption to the department.

(4) This subdivision shall not apply to or be used in conjunction with either the Small Timberland Owner Exemption created pursuant to subdivision (j) of Section 4584 or with the Forest Fires Prevention Exemption created pursuant to subdivision (k) of Section 4584.

(m) Helicopter yarding shall be prohibited.

(n) All applicable provisions of the Professional Foresters Law, including, but not limited to, Sections 775 to 779, inclusive, of this code, as well as all applicable provisions of Registration of Professional Forester Rules, including, but not limited to, Sections 1612 to 1614, inclusive, of Title 14 of the California Code of Regulations apply to the practice of professional forestry as it relates to this section.

4584.5. Yield Taxes.

Nothing in Section 4584 shall exempt the owner of any timber harvested from registering with the State Board of Equalization or from the payment of any applicable timber yield taxes imposed pursuant to Section 38115 of the Revenue and Taxation Code.

4585. Report of completion of work described in plan; partial completion report.

(a) Within one month after completion of the work described in the timber harvesting plan or nonindustrial timber harvest notice, excluding work for stocking, Site Preparation, or maintenance of drainage facilities and soil stabilization treatments on skid trails, roads, and Landings after the plan period, a report shall be filed by the Timber Owner or the owner's agent with the department that all work, except stocking, Site Preparation, or maintenance of drainage facilities and soil stabilization treatments, has been completed.

(b) If all of the work described in the plan has not been completed, a report may be filed annually with respect to a portion of the area covered by the plan which has been completed. The portion completed shall be adequately identified on a map submitted with the report.

4586. Inspection of completed work.

Within six months of the receipt of the work completion report specified in Section 4585, the director shall determine, by inspection, whether the work described in the report has been properly completed in conformity with the Rules and regulations of the board and the standards of this chapter. If the work has been so completed, the director shall issue a report of satisfactory completion of the work. If not, the director shall take corrective action as the director determines to be appropriate in accordance with Article 8 (commencing with Section 4601).

4587. Stocking report; filing date; sampling procedures; waiver.

(a) Within five years after completion of Timber Operations on an area identified in a report submitted pursuant to Section 4585 or nonindustrial timber harvest notice, a report of stocking with respect to that area shall be filed by the Timber Owner or the owner's agent with the department. A separate report of stocking may be filed with the work completion report for those areas which meet stocking requirements upon completion of Timber Operations. The board, by regulation, shall establish one or more statistically valid standardized sampling procedures which shall be designed to measure the number of trees and their dispersion.

Z'BERG-NEJEDLY FOREST PRACTICE ACT

(b) Notwithstanding subdivision (a), the board shall adopt regulations which specify the conditions and manner in which the necessity of employing sampling procedures may be waived. The regulations shall provide that, in addition to any other possible conditions which may be required by the board, the standard sampling procedures may be waived only if the director or the director's representative and the Timber Owner or a registered professional forester acting as the owner's agent, agree that the area is adequately stocked to meet the standards of this chapter and any applicable Rules or regulations of the board. The regulations shall require that, if the director or the director's representative does not agree that the area is so stocked, a standardized sample shall be required.

4588. Inspection of stocking; report of satisfactory completion.

Within six months of the receipt of the stocking report, the director shall determine, by inspection, whether the stocking has been properly completed. If the stocking is properly completed, the director shall issue a report of satisfactory completion of stocking. If the stocking is not properly completed, the director shall take corrective action as the director deems appropriate in accordance with Article 8 (commencing with Section 4601) of this chapter.

4589. Exemption and Emergency Monitoring.

(a) The department and board, in consultation with the Department of Fish and Wildlife, and the State Water Resources Control Board, shall commencing December 31, 2019, and annually thereafter, review and submit a report to the Legislature on the trends in the use of, compliance with, and effectiveness of, the exemptions and emergency notice provisions described in Sections 4584 and 4592 of this code and Sections 1038 and 1052 of Title 14 of the California Code of Regulations. The report shall include an analysis of exemption use and whether the exemptions are having the intended effect. The report shall also include recommendations to improve the use of those exemptions and emergency notice provisions, information on the linear distance of road constructed or Reconstructed under notices of exemption by individual ownerships, within a representative sample of planning watersheds from each forest practice district as defined in Sections 907 to 909, inclusive, of Title 14 of the California Code of Regulations, and violations associated with road reconstruction. The report shall include information on the number and type of violations and enforcement actions taken on each notice of exemption and emergency notice. The report shall also contain the number of post-treatment onsite inspections that occur and whether those inspections were attended by a representative of the Department of Fish and Wildlife and a representative of the State Water Resources Control Board. The report submitted on December 31, 2025, shall include recommendations necessary for revisions to diameter limits at stump heights of harvestable trees under subdivisions (j) and (k) of Section 4584.

(b) The public shall be provided opportunities to participate in the review and the development of the report.

(c) The report shall be submitted pursuant to Section 9795 of the Government Code.

(d) (A) This section shall be operative for a period of five years after the effective date of emergency regulations as adopted by the board and as of that date is inoperative.

(B) The board shall notify the Secretary of State when emergency regulations have been adopted.

4590. Term of plan and stocking work; extensions.

(a) (1) A timber harvesting plan approved on or after July 1, 2012, is effective for a period of not more than five years, unless extended pursuant to paragraph (2).

(2) A timber harvesting plan, on which Timber Operations have commenced but not been completed, may be extended by amendment for a two-year period in order to complete the Timber Operations if both of the following occur:

(A) Good cause is shown.

(B) All Timber Operations are in conformance with the timber harvesting plan, this chapter, and all applicable Rules and regulations, upon the filing of the notice of extension as

Z'BERG-NEJEDLY FOREST PRACTICE ACT

required by this section.

(b) The extension shall apply to any area covered by the plan for which a report has not been submitted under Section 4585. The notice of extension shall be provided to the department not sooner than 140 days, but at least 10 days, prior to the expiration date of the plan. The notice shall include the circumstances that prevented a timely completion of the Timber Operations under the plan and, consistent with Section 4583, an agreement to comply with this chapter and the Rules and regulations of the board as these exist on the date the extension notice is filed.

(c) Stocking work may continue for more than the effective period of the plan under subdivision (a), but shall be completed within five years after the conclusion of other work.

(d) In addition to the extension authorized by paragraph (2) of subdivision (a), a timber harvesting plan that is approved by the department from January 1, 2014, to December 31, 2015, inclusive, may be extended by amendment for an additional two years in order to complete the Timber Operations, up to a maximum of two two-year extensions, if the plan complies with subparagraphs (A) and (B) of paragraph (2) of subdivision (a) and the notice of extension, pursuant to subdivision (b), includes written certification by a registered professional forester that neither of the conditions in subdivision (e) has occurred.

(e) The department shall not approve an extension pursuant to subdivision (a) or (d) if either of the following has occurred:

(1) Listed species, as defined in Article 1 (commencing with Section 2050) of Chapter 1.5 of Division 3 of the Fish and Game Code or the federal Endangered Species Act (16 U.S.C. Sec. 1531 et seq.), have been discovered in the logging area of the plan since approval of the timber harvesting plan.

(2) Significant physical changes to the harvest area or adjacent areas have occurred since the timber harvesting plan's cumulative Impacts were originally assessed.

(f) An extension of a timber harvesting plan on which either of the conditions in subdivision (e) has occurred may be obtained only pursuant to Section 1039 of Title 14 of the California Code of Regulations.

4591. Amendments to plan; term of amendment.

Amendments to the original timber harvesting plan may be submitted detailing proposed changes from the original plan. Substantial deviations from the original plan shall not be undertaken until the amendment has been filed with, and acted upon, by the department in accordance with Sections 4582.7 and 4583. An amendment may not extend the effective period of the plan, except as provided in Section 4590.

4591.1. Permissible deviations.

The board shall specify by regulation those deviations which may be undertaken by an operator without submission of an amended plan but which must subsequently be reported to the department, and provide for the manner of so reporting.

4592. Emergency notice; contents.

Notwithstanding any other provisions of this chapter, a registered professional forester may in an emergency, on behalf of a Timber Owner or operator, file an "emergency notice" with the department that shall allow immediate commencement of Timber Operations. The emergency notice shall include a declaration, under penalty of perjury, that a bona fide emergency exists which requires immediate harvest activities, and that any applicable timber yield taxes will be paid pursuant to Section 38115 of the Revenue and Taxation Code. Those emergencies shall be defined by the board and may include, but are not limited to, the necessity to harvest to remove fire-killed or damaged timber or insect or disease-infested timber, or to undertake emergency repairs to roads.

4592.5. Timber harvesting plans; guidance and assistance

(a) The department shall provide guidance and assistance to ensure the uniform and efficient implementation of processes and procedures regulating the filing, review, approval, required

Z'BERG-NEJEDLY FOREST PRACTICE ACT

modification, completion, and appeal of decisions relating to timber harvesting plans. The guidance and assistance shall comply with all of the following requirements:

(1) A plan submitter has the expectation of a timely determination under Section 4582.7 and any relevant administrative regulations.

(2) The department shall provide clearly written guidance documents that explain the regulatory process. In this context, the department shall publish a list of all information required in a plan, using the rules of the board, and an explanation of the criteria that will be used by the department to determine whether the information contained in a plan at the time of submission is adequate.

(3) The department, using the rules of the board, shall provide a checklist that if properly followed by the registered professional forester, should result in a plan that complies with Section 4582 for the purposes of filing. The department, in the implementation of an electronic plan submission program, shall incorporate procedures that address this information.

(b) In addition to the requirements in subdivision (a), the department shall issue guidance to achieve greater timber harvesting plan review accuracy and efficiency and to avoid duplication of efforts. The guidance shall include guidance to responsible agencies that rely on the timber harvesting plan for their analysis under the California Environmental Quality Act (Division 13 (commencing with Section 21000)) when the agencies are issuing a permit to enable implementation of all or part of the project. This guidance shall assist the responsible agencies to avoid duplication in information requests for the responsible agencies permits. Responsible agencies are encouraged to include mitigation measures prior to the close of public comment to ensure they are examined at a sufficient level of detail prior to the close of public comment.

(c) This section does not preclude the department or other public agencies from imposing postapproval compliance requirements as the result of newly discovered or unforeseen conditions.

(d) For purposes of this section, "plan" or "timber harvesting plan" includes all forms or documents required to be submitted to the department for review, including, but not limited to, timber harvesting plan documents, program timberland environmental Impact reports, program timber harvest plans, modified timber harvesting plans, nonindustrial timber management plans, sustained yield plans, and working forest management plans.

Article 7.5. Nonindustrial Timber Management Plan.

The State Board of Forestry shall adopt Rules and regulations to implement Article 7.5 (commencing with Section 4593) of Chapter 8 of Part 2 of Division 4 of the Public Resources Code, not later than January 1, 1991. The Rules and regulations shall include all of the following:

(a) The conduct by the Department of Forestry and Fire Protection of one or more preharvest inspections of the land on which a nonindustrial timber management plan is proposed to be implemented, prior to the Director of Forestry and Fire Protection taking action to approve or deny the plan.

(b) Procedures for the Department of Forestry and Fire Protection to follow in conducting inspections of annual Timber Operations for which a notice is filed pursuant to Section 4594 of the Public Resources Code, for purposes of determining (1) whether the objectives of uneven aged management and sustained yield are being met for each parcel or group of contiguous parcels covered by the plan, and (2) compliance with the plan's other provisions, any Rules and regulations of the State Board of Forestry, or Chapter 8 (commencing with Section 4511) of Part 2 of Division 4 of the Public Resources Code.

(c) Procedures for the Department of Forestry and Fire Protection to follow to cancel a nonindustrial timber management plan pursuant to Section 4594.7 or the Public Resources Code, or terminate Timber Operations conducted pursuant to the plan, if the objectives of uneven aged management and sustained yield are not being met, or there are persistent violations that are not corrected by the landowner or Timber Operator.

The department shall, on or before January 1, 1998, report to the Governor and the Legislature with an evaluation on whether the objectives of unevenaged management and sustained yield are

Z'BERG-NEJEDLY FOREST PRACTICE ACT

being met for each parcel or group of contiguous parcels for which a nonindustrial timber management plan has been approved pursuant to this act.

4593. Legislative findings and declaration.

(a) The Legislature finds and declares that a substantial acreage of Timberlands of the state are held by private nonindustrial owners and that it is the policy of the state to increase the productivity of these Timberlands under prudent management plans to serve the public's need for timber and other forest products.

(b) The Legislature further finds and declares that minimal environmental harm is caused by prudent management of nonindustrial Timberlands because low volume production and dispersion around the state of these small tracts reduces damage to aesthetics, air quality, watersheds, and wildlife.

(c) The Legislature further finds and declares that it is the policy of the state to encourage prudent and responsible forest resource management of nonindustrial Timberlands by approving nonindustrial timber management plans in advance and withdrawing governmental discretion to disapprove nonindustrial timber harvest notices submitted pursuant to the approved nonindustrial timber management plans.

(d) It is not the intent of the Legislature by the enactment of this article to limit the penalties and the enforcement provisions of this chapter.

4593.2. Definitions.

Notwithstanding Section 4521, unless the context otherwise requires, the following definitions govern construction of this article:

(a) "Nonindustrial Timberlands" means Timberland owned by a nonindustrial tree farmer.

(b) "Nonindustrial tree farmer" means an owner of Timberland with less than 2,500 acres who has an approved nonindustrial management plan and is not primarily engaged in the manufacture of forest products.

(c) "Uneven aged management" means the management of a specific forest, with the goal of establishing a well-stocked stand of various age classes and which permits the periodic harvest of individual or small groups of trees to realize the yield and continually establish a new crop.

(d) "Sustained yield" means the yield of commercial wood that an area of commercial Timberland can produce continuously at a given intensity of management consistent with required environmental protection and which is professionally planned to achieve over time a balance between growth and removal.

(e) "Nonindustrial timber management plan" means a management plan for nonindustrial Timberlands with an objective of an uneven aged managed timber stand and sustained yield for each parcel or group of contiguous parcels meeting the requirements of Section 4593.3. A nonindustrial timber management plan may include multiple nonindustrial tree farmers, but shall not cover more than 2,500 acres.

(f) "Nonindustrial timber harvest notice" means notice of timber harvest operations pursuant to an approved nonindustrial timber management plan and meeting the requirements of Section 4594.

4593.3. Filing of plan; preparation; contents.

A non-industrial timber management plan may be filed with the department in writing by a person who intends to become a nonindustrial tree farmer with the long-term objective of an unevenaged timber stand and sustained yield through the implementation of a nonindustrial timber management plan. The nonindustrial timber management plan shall be prepared by a registered professional forester. It shall be a public record and shall include all of the following information:

(a) The name and address of the Timberland Owner.

(b) A description of the land on which the nonindustrial timber management plan is proposed to be implemented, including a United States Geological Survey quadrangle map or equivalent indicating the location of all streams, the location of all proposed and existing logging truck roads, and indicating boundaries of all site I classification Timberlands to be stocked in accordance with

Z'BERG-NEJEDLY FOREST PRACTICE ACT

subdivision (b) of Section 4561 and any other site classifications if the board establishes specific minimum stocking standards for other site classifications.

(c) A description of the silviculture methods to be applied and the type of Yarding equipment to be used.

(d) An outline of the methods to be used to avoid excessive accelerated erosion from Timber Operations to be conducted within the proximity of a stream.

(e) Special provisions, if any, to protect any unique area within the boundaries of the proposed nonindustrial timber management plan.

(f) A description of the existing stand, its current projected growth, alterations required to achieve the management objectives, the projected timber volumes and tree sizes to be available for harvest, and projected frequencies of harvest.

(g) A certification by the registered professional forester preparing the nonindustrial timber management plan that the registered professional forester or a designee has personally inspected the plan area.

(h) Any other information the board provides by regulation to meet its Rules and the standards of this chapter.

4593.4. Notice of receipt of plan.

The board shall adopt regulations regarding the notice of receipt of the proposed nonindustrial timber management plan. The notice shall be given within two working days following submission of the proposed management plan and shall be consistent with Horn vs. County of Ventura, 24 Cal. 3rd 605, and all applicable laws. In adopting the regulations, the board shall take account of the extent of the administrative burden involved in giving the notice. The method of notice shall include, but not be limited to, mailed notice. The regulations may require the person submitting the nonindustrial timber management plan to provide to the department a list of the names and addresses of persons to whom the notice is to be mailed.

4593.5. Requests for notice.

The department shall provide notice of the filing of nonindustrial timber management plans to any person who requests, in writing, that notification.

4593.6. Public inspection of plan; copies for interdisciplinary review; comments from public agencies.

Upon receipt of the nonindustrial timber management plan, the department shall place it, or a true copy thereof, in a file available for public inspection in the county in which Timber Operations are proposed under the plan, and, for the purpose of interdisciplinary review, shall transmit a copy to the Department of Fish and Game, the appropriate California regional water quality control board, the county planning agency, and all other agencies having jurisdiction by law over natural resources affected by the plan. The department shall invite, consider, and respond in writing to comments received from public agencies to which the plan has been transmitted and shall consult with those agencies at their request.

4593.7. Review of plans; non-conforming plans; denial of plans; appeals.

(a) The director has 45 days from the date the initial inspection is completed as provided in Section 4604, or a longer period mutually agreed upon by the director and the person submitting the nonindustrial timber management plan, to review the plan to determine if the plan is in conformance with the Rules and regulations of the board and this chapter. If the director determines that the plan is not in conformance with the Rules and regulations of the board or this chapter, the director shall return the plan, stating his or her reasons and advising the person submitting the plan of the person's right to a hearing before the board.

(b) If the director does not act within the time periods provided in subdivision (a), a longer period shall be negotiated and mutually agreed upon by the director and the person submitting the nonindustrial timber management plan. If a longer period cannot be mutually agreed upon, the

Z'BERG-NEJEDLY FOREST PRACTICE ACT

nonindustrial timber management plan shall be deemed denied and returned to the person submitting the plan.

(c) A person to whom a plan is returned may, within 10 days from the receipt of the plan, request the board for a public hearing before the board. The board shall schedule a public hearing to review the plan to determine if the plan is in conformance with the Rules and regulations of the board and this chapter. Board action shall take place within 30 days from the filing of the appeal, or a longer period mutually agreed upon by the board and the person filing the appeal. If the plan is not approved on appeal to the board, the director, within 10 days of board action, may determine that the plan is in conformance if the plan is revised to bring it into full conformance with the Rules and regulations of the board and this chapter.

4593.8. Amendment of approved plan.

The nonindustrial tree farmer may submit a proposed amendment to the approved plan and may not take any action which substantially deviates, as defined by the board, from the approved plan until the amendment has been filed with the director and the director has determined that the amendment is in compliance with the Rules and regulations of the board and the provisions of this chapter which were in effect at the time the nonindustrial timber management plan was approved, in accordance with the same procedures specified in Section 4593.7.

4593.9. Non-substantial deviations from plan.

The non-industrial tree farmer may take actions which do not substantially deviate from the approved plan without the submittal of an amendment, but those actions shall be subsequently reported to the department. The board shall specify, by regulation, those nonsubstantial deviations which may be taken. The board shall specify the requirements for reporting those deviations.

4593.10. Change of land ownership; duty of transferring landowner to notify acquiring landowner of existence of plan; notice provided by department; notice of assumption of plan; violation.

(a) Upon a change of ownership of the land described in the nonindustrial timber management plan, the transferring landowner shall provide the acquiring landowner with written notice that discloses the existence of the plan and informs the acquiring landowner of the need to notify the department if the acquiring landowner intends to assume the plan. The transferring landowner shall also send the department a copy of the notice provided to the acquiring landowner.

(b) If the transferring landowner fails to provide the notice required in subdivision (a) and the department discovers the change of ownership, the department shall provide the acquiring landowner with the notice described in subdivision (a).

(c) The acquiring landowner shall have one year from the date of the receipt of the notice required pursuant to subdivision (a) or (b), whichever is applicable, to notify the department in writing of his or her assumption of the plan. If the department does not receive notification within this period, the department may cancel the plan.

(d) A violation of this section by a landowner does not constitute a crime pursuant to Section 4601.

4593.11. Cancellation of plan by tree farmer.

The nonindustrial tree farmer may cancel the nonindustrial timber management plan by submitting a written notice to the department. Once Timber Operations have commenced pursuant to a nonindustrial timber harvest notice, cancellation is not effective on land covered by the notice until a report of satisfactory completion has been issued pursuant to Sections 4585, 4586, and 4587.

4594. Notice of harvest within area covered by a plan; contents of notice.

The nonindustrial tree farmer who owns, leases, or otherwise controls or operates on all or any portion of any Timberland within the boundaries of an approved nonindustrial timber management plan, and who plans to harvest any of the timber thereon during a given year, shall file a

Z'BERG-NEJEDLY FOREST PRACTICE ACT

nonindustrial timber harvest notice with the department in writing. A notice shall be filed prior to the harvesting of any timber and shall be effective for a maximum of one year from the date of filing. If the person who files the notice is not the owner of the Timberland, the person filing the notice shall notify the Timberland Owner by certified mail that the notice has been submitted, and shall certify that mailing to the department. The notice shall be a public record and shall include all of the following information:

- (a) The name and address of the Timber Owner.
- (b) The name and address of the Timber Operator.
- (c) The name and address of the registered professional forester preparing the nonindustrial timber harvest notice.
- (d) A description of the land on which the work is proposed to be done.
- (e) A statement that no archeological sites have been discovered in the harvest area since the approval of the nonindustrial timber management plan.
- (f) A statement that no rare, threatened, or endangered plant or animal species has been discovered in the harvest area since the approval of the nonindustrial timber management plan.
- (g) A statement that there have been no physical environmental changes in the harvest area that are so significant as to require any amendment of the nonindustrial timber harvest plan.
- (h) A certification by the registered professional forester that the notice as carried out will implement best management practices for protection of the beneficial uses of water, soil stability, forest productivity, and wildlife as required by the current Rules of the board, or a certification that practices consistent with the original plan will not result in any significant degradation to the beneficial uses of water, soil stability, forest productivity, or wildlife.
- (i) Special provisions, if any, to protect any unique area within the area of Timber Operations.
- (j) The expected dates of commencement and completion of Timber Operations during the year.
- (k) A statement that the harvesting notice conforms to the provisions of the approved management plan.
- (l) Any other information the board provides by regulation to meet its Rules and the standards of this chapter.
- (m) This section shall become operative on January 1, 1996.

4594.2. Deviations from plan; notice by professional forester.

The registered professional forester who prepares the nonindustrial timber management plan or prepares the notice, or any other registered professional forester who is employed by the owner or operator, shall report to the owner or operator if there are deviations from the plan which, in his or her judgment, threaten the attainment of the resource conservation standards of the plan.

4594.4. Material misstatement by professional forester; disciplinary action.

If the board finds that a registered professional forester has made any material misstatement in any nonindustrial timber harvesting notice, nonindustrial timber management plan, or report under this chapter, the board shall take disciplinary action against that registered professional forester as provided under Section 775.

4594.6. Commencement of Timber Operations.

Notwithstanding any other provisions of this chapter, if a registered professional forester certifies by written declaration, on behalf of the Timber Owner or operator, that the nonindustrial timber harvesting notice conforms to, and meets the requirements of, the approved nonindustrial timber management plan under which it is filed, Timber Operations may commence immediately unless the notice has been filed by mailing, in which case operations may commence three days after the notice has been mailed.

4594.7. Cancellation of plan by department.

If it is determined that the objectives of uneven aged management and sustained yield are not being met by a nonindustrial tree farmer, or there are other persistent violations detected that are not being

Z'BERG-NEJEDLY FOREST PRACTICE ACT

corrected, a previously approved nonindustrial timber management plan shall be canceled by the department and any further Timber Operations under the plan shall be terminated.

Article 7.7. Working Forest Management Plan.

4597. Findings and declarations.

(a) The Legislature finds and declares all of the following:

(1) The nonindustrial timber management plan established pursuant to Article 7.5 (commencing with Section 4593) has been successful in meeting the intent of this chapter by encouraging prudent and responsible forest management and discouraging accelerated Timberland conversion by private nonindustrial forest landowners.

(2) There have been more than 850 nonindustrial timber management plans approved by the department covering a combined area of more than 360,000 acres.

(3) Building upon the model provided by the nonindustrial timber management plan, it is the policy of the state to encourage long-term planning, increased productivity of Timberland, and the conservation of open space on a greater number of nonindustrial working forest ownerships and acreages.

(4) It is the policy of the state to encourage prudent and responsible forest resource management of nonindustrial Timberlands by approving working forest management plans in advance and authorizing working forest timber harvest notices to be filed ministerially.

(5) To ensure long-term benefits such as added carbon sequestration, local and regional employment and economic activity, sustainable production of timber and other forest products, aesthetics, and the maintenance of ecosystem processes and services, the working forest management plan shall comply with rigorous timber inventory standards that are subject to periodic review and verification.

(b) This article shall be implemented in a manner that complies with the applicable provisions of this chapter and other laws, including, but not limited to, the Timberland Productivity Act of 1982 (Chapter 6.7 (commencing with Section 51100) of Division 1 of Title 5 of the Government Code), the California Environmental Quality Act (Division 13 (commencing with Section 21000) of the Public Resources Code), the Porter Cologne Water Quality Control Act (Division 7 (commencing with Section 13000) of the Water Code), and the California Endangered Species Act (Chapter 1.5 (commencing with Section 2050) of the Fish and Game Code). Working forest landowners, as defined in Section 4597.1, shall comply with all applicable regulatory requirements of the State Water Resources Control Board and the appropriate regional water quality control board.

4597.1. Definitions.

Notwithstanding Section 4521, unless the context otherwise requires, the following definitions govern construction of this article:

(a) "Long-term sustained yield" means the average annual growth sustainable by the inventory predicted at the end of a 100-year planning horizon, or a shorter planning horizon if the forest encompassed by the working forest management plan has reached a balance between growth and yield.

(b) "Major stand type" means a stand that occupies an area equal to or greater than 25 percent of a working forest management plan.

(c) "Management unit" means a geographically identifiable area delineated for silviculture or management purposes. A management unit is intended to reflect an area scheduled for harvest under the plan in any given year, but may also be designated to address specific resource sensitivities.

(d) "Stand" means a geographically identifiable group of trees sufficiently uniform in age-class distribution, composition, and structure and growing on a site of sufficiently uniform quality to be a distinguishable unit.

(e) "Strata" means a grouping of similar stands defined for silvicultural or management purposes, usually according to similarities in stand composition, structure, and age.

(f) "Sustained yield" means the yield of commercial wood that an area of commercial Timberland

Z'BERG-NEJEDLY FOREST PRACTICE ACT

can produce continuously at a given intensity of management consistent with required environmental protection and that is professionally planned to achieve over time a balance between growth and removal. Sustained yield management implies continuous production planned so as to achieve, at the earliest practical time, a balance between growth and harvest.

(g) "Uneven aged management" means forest management with the goal of establishing a well-stocked stand of various age classes, which permits the periodic harvest of individual or small groups of trees to achieve sustained yield objectives of the working forest management plan, and provide for regeneration of trees and maintenance of age class structure.

(h) "Working forest harvest notice" means notice of timber harvest operations, pursuant to an approved working forest management plan, which meets the requirements of Section 4597.11.

(i) "Working forest landowner" means an owner of Timberland with less than 10,000 acres who has an approved working forest management plan and is not primarily engaged in the manufacture of forest products.

(j) "Working forest management plan" means a management plan for working forest Timberlands, with objectives of maintaining, restoring, or creating uneven aged managed timber stand conditions, achieving sustained yield, and promoting forestland stewardship that protects watersheds, fisheries and wildlife habitats, and other important values. A working forest management plan may include multiple working forest landowners, but shall cover no more than 10,000 acres of timberland. The harvest area, as defined in Section 895.1 of Title 14 of the California Code of Regulations, of a working forest management plan must be contained within a single hydrologic area as defined by State Water Resources Control Board's CalWater 2.2.

(k) "Working forest Timberlands" means Timberland owned by a working forest landowner.

4597.2. Working forest management plans; contents.

A working forest management plan may be submitted to the department in writing by a person who intends to become a working forest landowner with the long-term objective of an uneven aged timber stand and sustained yield through the implementation of a working forest management plan. The management plan shall be prepared by a registered professional forester. It shall be public record and shall include all of the following information:

(a) The name and address of the Timberland Owner.

(b) A description of the land on which the plan is proposed to be implemented, including a United States Geological Survey quadrangle map or equivalent indicating the location of all streams, the location of all proposed and existing logging truck roads, and the boundaries of all site I classification Timberlands to be stocked in accordance with subdivision (b) of Section 4561 and any other site classifications if the board establishes specific minimum stocking standards for other site classifications.

(c) A description by the registered professional forester of the inventory design and timber stand stratification criteria that demonstrates that the inventory supporting the growth and yield calculations used to determine long-term sustained yield for the working forest management plans meets the following minimum standards:

(1) For major stand or strata, the inventory estimate shall be within 15 percent of the mean at one standard error.

(2) For stand or strata that make up greater than 10 percent and less than 25 percent of the working forest management plan area, the estimate shall be no greater than 25 percent of the mean at one standard error.

(3) Inventory estimates and growth and yield shall be projected for the purposes of determining long-term sustained yield and volumes available for harvest by stand or strata and aggregated for the area covered by the working forest management plan to develop the long-term sustained yield estimate. Long-term sustained yield estimates shall reasonably reflect constraints applicable to the working forest Timberlands on forest management activities.

(d) All necessary information shall demonstrate compliance with Article 12 (commencing with Section 923) of Subchapter 4 of, Article 11 (commencing with Section 943) of Subchapter 5 of, and Article 12 (commencing with Section 963) of Subchapter 6 of, Division 1.5 of Title 14 of the

Z'BERG-NEJEDLY FOREST PRACTICE ACT

California Code of Regulations.

(e) Special provisions to protect unique areas, if any, within the boundaries of the proposed working forest management plan.

(f) A description of the property and planned activities including acres and projected growth, existing stand types, major stand types or strata, its current projected growth by strata, silvicultural applications to be applied to strata to achieve long-term sustained yield, projected timber volumes and tree sizes to be available for harvest, and projected frequencies of harvest.

(g) **(1)** A description of late succession forest stands in the plan area and how the total acreage of this type of habitat will be maintained across the plan area under a constraint of no net loss. Nothing in this requirement shall be interpreted to preclude active management on any given acre of an approved plan if the management is conducted in a manner that maintains or enhances the overall acreage of late succession forest stands that existed in the plan area upon initial plan approval. An exception to the no net loss constraint may be granted in the event of a catastrophic loss due to emergency factors such as wildfire, insect, and disease activity. The description shall include the following:

(A) Retention measures for existing biological legacies such as snags, trees with cavities or basal hollows, and down logs, and address how those legacies shall be managed over time appropriate with the forest type, climate, and landowner's forest fire fuels and wildlife management objectives.

(B) Hardwood tree species and how they will be managed over time.

(2) Late succession forest stand types or strata shall be mapped.

(3) Notwithstanding the definition of late succession forest stands in Section 895.1 of Title 14 of the California Code of Regulations, and for the sole purpose of this article, "late succession forest stands" means stands of dominant and predominant trees that meet the criteria of the California Wildlife Habitat Relationships System class 5D, 5M, or 6 with an open, moderate, or dense canopy closure classification, often with multiple canopy layers, and are at least 10 acres in size. Functional characteristics of late succession forest stands include large decadent trees, snags, and large down logs.

(h) Disclosure of state or federally listed threatened, candidate, endangered, or rare plant or animal species located within the biological assessment area, their status and habitats, take avoidance methodologies, enforceable protection measures for species and habitats, and how forest management will maintain these over time.

(i) **(1)** A description of the following for each management unit:

(A) Acres by stand or strata and estimated growth and yield for each planned harvest entry covering the period of time the long-term sustained yield plan establishes as necessary to meet growth and yield objectives. The growth and yield estimates may be based on weighted average of yield for the stand types or strata within the area included in the management unit.

(B) Yarding methods to be used.

(C) Management units shall be mapped.

(2) **(A)** For long-term sustained yield projections, pursuant to subdivision (c), that project a reduction in quadratic mean diameter of trees greater than 12 inches in diameter or a reduced level of inventory for a major stand type or for a stand or strata that make up greater than 10 percent and less than 25 percent of the working forest management plan area, an assessment shall be included that does all of the following:

(i) Addresses candidate, threatened, endangered, and sensitive species, and other fish and wildlife species that Timber Operations could adversely impact by potential changes to habitat.

(ii) Addresses species habitat needs utilizing the "WHR system" described in "A Guide to Wildlife Habitats in California," California Department of Fish and Wildlife, 1988, or comparable typing system.

(iii) Addresses constraints to timber management, the Impact of the availability and distribution of habitats on the ownership and within the cumulative Impacts assessment area identified in the plan in relation to the harvest schedule, and the Impacts of the

Z'BERG-NEJEDLY FOREST PRACTICE ACT

planned management activities utilizing the existing habitat as the baseline for comparison.

(iv) Discusses and includes feasible measures planned to avoid or mitigate potentially significant adverse Impacts on fish or wildlife, which can include, but is not limited to, recruitment or retention of large down logs greater than 16 inches in diameter and 20 feet in length, retention of trees with structural features such as basal hollows, cavities, large limbs, or broken tops, retention of hardwoods, and retention or recruitment of snags greater than 24 inches in diameter and 16 feet in height.

(j) A certification by the registered professional forester preparing the plan that the forester or a designee has personally inspected the plan area.

(k) A certification by the registered professional forester preparing the plan that the forester or a designee has clearly explained to the working forest landowner that the plan is a long-term commitment that may require ongoing investments, including inventory sampling and road maintenance, for the purpose of managing the plan.

(l) Any other information the board requires by regulation to meet its Rules and the standards of this chapter.

4597.3. Regulations regarding notice of receipt of proposed working forest management plan.

The board shall adopt regulations regarding the notice of receipt of the proposed working forest management plan. The notice shall be given within two working days following receipt of the proposed management plan and shall be consistent with all applicable laws. The method of notice shall include, but not be limited to, mailed notice and Internet-based notice. The regulations may require the person submitting the working forest management plan to provide to the department a list of the names and addresses of persons to whom the notice is to be mailed.

4597.4. Required notices; Internet Web site and in writing by request.

The department shall provide notice of the filing of working forest management plans, the proposed plans, and working forest harvest notices on its Internet Web site, and to any person who requests, in writing, that notification.

4597.5. Public inspection of propose plan; transmission to other state and regional agencies; invitation of public comments.

Upon receipt of the proposed working forest management plan, the department shall place the proposed plan, or a true copy of the proposed plan, in a location or on an Internet Web site available for public inspection in the county in which Timber Operations are proposed under the plan. For the purpose of interdisciplinary review, the department shall also transmit a copy to the Department of Conservation, the Department of Fish and Wildlife, the appropriate California regional water quality control board, the county planning agency, and all other agencies having jurisdiction by law over natural resources affected by the plan. The department shall invite, consider, and respond in writing to comments received from public agencies to which the plan has been transmitted and shall consult with those agencies at their request.

4597.6. Time for public comment; requirements for approval; denial; hearing revised plans.

(a) The department shall provide a time period for public comment, starting from the date of the receipt of a working forest management plan, as follows:

(1) Ninety days for a working forest management plan for less than 5,000 acres.

(2) One hundred ten days for a working forest management plan for between 5,000 and 10,000 acres.

(b) Before a working forest management plan may be approved, all of the following requirements shall be met:

(1) Within 30 working days of the receipt of a working forest management plan, or within 40 working days of the receipt of a plan to which a road management plan is appended, the department shall determine if the plan is accurate, complete, and in proper order, and if so, the plan shall be filed. An unfiled plan shall be returned to the applicant with an explanation that includes

Z'BERG-NEJEDLY FOREST PRACTICE ACT

provisions for resubmitting the plan.

(2) The initial inspection shall be initiated within 20 working days from the date of filing of the working forest management plan, and completed no more than 30 working days from the date of filing.

(3) Upon completion of the initial inspection, the department shall have up to 45 working days to conduct the final interagency review of the plan.

(4) The public comment period shall end 20 working days after the completion of the final interagency review of the plan or until the requirement in subdivision (a) is met, whichever is greater.

(5) After the final interagency review and public comment period has ended, the department shall have up to 30 working days to review the public input, to consider recommendations and mitigation measures of other agencies, to respond in writing to the issues raised, and to determine if the plan is in conformance with the applicable Rules adopted by the board and other applicable provisions of law.

(c) If after final interagency review the director determines that the plan is not in conformance with the Rules and regulations of the board or this chapter, the director shall deny and return the plan, stating the reasons for the denial and advising the person submitting the plan of the person's right to a hearing before the board.

(d) If the director does not act within the time periods provided in paragraphs (1) through (5) in subdivision (b), the director and the working forest landowner submitting the working forest management plan shall negotiate and mutually agree upon a longer period for the director to review the plan. If a longer period cannot be mutually agreed upon, the working forest management plan shall be deemed denied and returned to the working forest landowner submitting the plan.

(e) (1) A working forest landowner to whom a plan is denied pursuant to subdivision (c) or (d) may request, within 30 working days from the receipt of the plan, a public hearing before the board. The board shall schedule a public hearing to review the plan to determine if the plan is in conformance with the Rules and regulations of the board and this chapter.

(2) Board action shall take place within 30 working days from the filing of the appeal, or a longer period mutually agreed upon by the board and the person filing the appeal.

(3) If the director's decision to deny the plan is overturned by the board, the board shall prepare findings and its rationale for overturning the decision, and return the plan to the department for approval by the director.

(4) If the plan is not approved on appeal to the board, the director, within 10 working days of board action, shall advise the plan submitter regarding changes needed that would achieve compliance with this chapter and other applicable provisions of the law. The plan submitter shall have 45 working days from the date of the notification letter, or longer, if mutually agreeable to the department and the plan submitter to revise the plan to bring it into full conformance with the Rules and regulations of the board and this chapter. Upon receipt of the information requested of the plan submitter, the department shall recirculate the plan and reopen the public comment period for 30 working days. Prior to determining whether to approve the proposed revised plan, the director shall have 30 working days to review public input and consider recommendations and mitigation measures of other agencies, and to respond in writing to issues raised.

4597.7. Amendments to plan; proposal; public comment and review.

The working forest landowner may submit a proposed amendment to the approved plan and shall not take any action that substantially deviates, as defined by the board, from the approved plan until the amendment has been filed with the director and the director has determined, after completion of the interagency review and public comment period, either of the following:

(a) The amendment is in compliance with the current Rules and regulations of the board and the provisions of this chapter.

(b) The amendment is in compliance with the Rules and regulations of the board and the provisions of this chapter that were in effect at the time the working forest management plan was approved. The director may only make this determination if the registered professional forester

Z'BERG-NEJEDLY FOREST PRACTICE ACT

explains, justifies, and certifies both of the following:

(1) The adherence to new or modified Rules and regulations of the board would cause unreasonable additional expense to the working forest landowner.

(2) Compliance with the Rules and regulations of the board and the provisions of this chapter that were in effect at the time the working forest management plan was approved will not result in any significant degradation to the beneficial uses of water, soil stability, forest productivity, or wildlife.

(c) Review timelines for substantial deviations of working forest management plans shall conform to the direction provided in Section 4582.7, except for amendments that add acreage covered by the original working forest management plan that exceeds 10 percent or 500 acres, whichever is greater. Amendments that add acreage in excess of 10 percent or 500 acres shall be reviewed pursuant to the procedures specified in Section 4597.6.

4597.8. Actions without submission of amendment; subsequent report; regulations.

The working forest landowner may take actions that do not substantially deviate from the approved plan without the submission of an amendment, but those actions shall be subsequently reported to the department. The board shall specify, by regulation, those nonsubstantial deviations that may be taken. The board shall specify the requirements for reporting those deviations.

4597.9. Change of land ownership; duty of transferring landowner to notify acquiring landowner of existence of plan; notice provided by department; notice of intent to assume plan; violation.

(a) Upon a change of ownership of the land described in the working forest management plan, the transferring landowner shall provide the acquiring landowner with written notice that discloses the existence of the plan and informs the acquiring landowner of the need to notify the department if the acquiring landowner intends to assume the plan. The transferring landowner shall also send the department a copy of the notice provided to the acquiring landowner.

(b) If the transferring landowner fails to provide the notice required in subdivision (a) and the department discovers the change of ownership, the department shall provide the acquiring landowner with the notice described in subdivision (a).

(c) The acquiring landowner shall have one year from the date of the receipt of the notice required pursuant to subdivision (a) or (b), whichever is applicable, to notify the department in writing of his or her intent to assume the plan. If the department does not receive notification within this period, the department may cancel the plan.

(d) A violation of this section by a landowner does not constitute a crime pursuant to Section 4601.

4597.10. Cancellation of plan; notice.

The working forest landowner may cancel the working forest management plan by submitting a written notice to the department. Once Timber Operations have commenced pursuant to a working forest harvest notice, cancellation is not effective on land covered by the notice until a report of satisfactory completion has been issued pursuant to Sections 4585, 4586, and 4587.

4597.11. Working forest harvest notice; requirements; duration.

The working forest landowner who owns, leases, or otherwise controls or operates on all or any portion of any Timberland within the boundaries of an approved working forest management plan, and who plans to harvest any of the timber during a given year, shall file a working forest harvest notice with the department in writing. A notice shall be filed prior to the harvesting of any timber and shall be effective for a maximum of one year from the date of filing. If the person who files the notice is not the owner of the Timberland, the person filing the notice shall notify the Timberland Owner by certified mail that the notice has been submitted and shall certify that mailing to the department. The notice shall be a public record and shall include all of the following information:

(a) The name and address of the Timber Owner.

Z'BERG-NEJEDLY FOREST PRACTICE ACT

- (b) The name and address of the Timber Operator.
- (c) The name and address of the registered professional forester preparing the working forest management plan.
- (d) A description of the land on which the work is proposed to be done.
- (e) A statement that no archaeological sites have been discovered in the harvest area since the approval of the working forest management plan.
- (f) A statement that state or federally listed rare, threatened, candidate, or endangered plant or animal species have not been discovered in the harvest area since the approval of the working forest management plan. Prior to submitting the notice, a review of the California Natural Diversity Database or other public databases for any species listed as threatened, endangered, candidate, or rare, or species that meet the criteria of endangered or rare as provided in Section 15380 of Title 14 of the California Code of Regulations, shall be conducted after the initial year after the plan is approved. When a notice of operations is filed after the initial year the plan is approved, it shall comply with the following:
 - (1) Documented occurrences obtained from a review of public and readily available sources of species state or federally listed as threatened, endangered, candidate, or rare within the biological assessment area and outside the area identified in the working forest harvest notice not addressed in the approved plan shall be submitted to the director as a minor deviation concurrently with the filing of a working forest harvest notice.
 - (2) Occurrences of species that are state or federally listed as threatened, endangered, candidate, or rare discovered inside the area identified in the working forest harvest notice not addressed in the approved plan shall be submitted to the director as an amendment to the plan prior to filing a working forest harvest notice. The amendment shall contain take avoidance and mitigation measures if no such information is currently contained within the approved plan.
- (g) A statement that there are no physical environmental changes in the harvest area that are so significant as to require any amendment of the working forest management plan.
- (h) A certification by the registered professional forester that states either of the following:
 - (1) The notice as carried out will protect the beneficial uses of water, soil stability, forest productivity, and wildlife as provided by the Rules and regulations of the board and other applicable provisions of law.
 - (2) Compliance with the Rules and regulations of the board and the provisions of this chapter that were in effect at the time the working forest management plan was approved will not result in any significant degradation to the beneficial uses of water, soil stability, forest productivity, or wildlife. This paragraph shall only apply if the forester certifies that adherence to current or modified Rules and regulations of the board would cause unreasonable additional expense to the working forest landowner.
- (i) Special provisions to protect unique areas, if any, within the area of Timber Operations.
- (j) The expected dates of commencement and completion of Timber Operations during the year.
- (k) A statement that the harvesting notice conforms to the provisions of the approved management plan. If any aspects of the proposed operation are less protective than the current forest practices Rules, an explanation of the deviation and how resource values will be adequately protected.
- (l) An update on erosion control mitigation measures for the harvest area and any appurtenant roads if conditions have changed since the working forest management plan was approved and a certification from the registered professional forester that no additional listings of water bodies to the Section 303(d) of the Clean Water Act (33 U.S.C. Sec. 1313(d)) list have occurred on the lands of the plan.
- (m) Any other information the board provides by regulation to meet its Rules and the standards of this chapter and other applicable provisions of law.

4597.12. Interdisciplinary review team; field inspections; five-year reviews; public notice; disclosure of proprietary information not authorized.

- (a) For an approved working forest management plan, the director shall convene a meeting with the interdisciplinary review team, as that term is used in subdivision (a) of Section 1037.5 of Title 14

Z'BERG-NEJEDLY FOREST PRACTICE ACT

of the California Code of Regulations, every five years to review the plan's administrative record, information obtained pursuant to subdivision (b), and any other information relevant to verify that operations have been conducted in accordance with the plan and applicable laws and regulations. Participation by review team agencies shall be at the discretion of each agency. If at this meeting a member of the review team determines that a field inspection is necessary to verify that operations have been conducted in accordance with the plan and applicable laws and regulations, then a field inspection may be conducted.

(b) For the purposes of subdivision (a), the board, in consultation with the review team agencies, shall adopt regulations that require the department to develop a plan summary before each five-year review that allows the review team to analyze information including, but not limited to, the number of notices of Timber Operations, the acreage operated under each notice, the violations received, and the volume harvested in relation to projections of harvest in the plan. If the department or a review team agency does not have direct access to information needed for the plan summary, the department may require the landowner to provide this information.

(c) For the purpose of allowing the public to monitor a working forest management plan, the department shall provide the public, in writing or on its Internet Web site, notice of each five-year review and a copy of the plan summary. The public may submit to the review team additional information relevant to the purpose of the five-year review and the review team may consider this information when conducting its review.

(d) This section does not authorize the public disclosure of proprietary information without first obtaining the landowner's consent.

4597.13. Registered professional forester; reports of deviation from plan.

The registered professional forester who prepares the working forest management plan or prepares the notice of harvest, or any other registered professional forester who is employed by the owner or operator, shall report to the owner or operator if there are deviations from the plan that, in the forester's judgment, threaten the attainment of the resource conservation standards of the plan.

4597.14. Registered professional forester; material misstatements in notice.

If the board finds that a registered professional forester has made any material misstatement in a working forest harvest notice, working forest management plan, or report pursuant to this chapter, the board shall take disciplinary action against the forester as provided pursuant to Section 775.

4597.15. Written declaration of registered professional forester; sufficiency of working forest harvest notice; commencement of operations.

Notwithstanding any other provisions of this chapter, if a registered professional forester certifies by written declaration, on behalf of the Timber Owner or operator, that the working forest harvest notice conforms to and meets the requirements of the approved working forest management plan under which it is filed, Timber Operations may commence immediately. If the notice has been filed by mailing, operations may commence three days after the notice has been mailed.

4597.16. Failure to meet objectives of uneven aged management and sustained yield or other persistent violations; cancellation, appeal.

If the department determines that the objectives of uneven aged management and sustained yield are not being met by a working forest landowner, or there are other persistent violations detected that are not being corrected, the department shall cancel a previously approved working forest management plan and any further Timber Operations under the plan shall be terminated. In making a determination to cancel a plan, the department may cite the findings of a review conducted pursuant to Section 4597.12. Cancellation of the plan may be appealed by the plan submitter or landowner utilizing the process prescribed in paragraph (1) of subdivision (e) of Section 4597.6.

4597.17. Landowner with less than 2,500 acres; expansion; amendment of plan.

If a landowner with a nonindustrial timber management plan or a working forest management plan

Z'BERG-NEJEDLY FOREST PRACTICE ACT

with less than 2,500 acres expands his or her total Timberland ownership to 2,500 or more acres, the landowner may transition into a working forest management plan for more than 2,500 acres through an amendment to the plan. The board shall adopt regulations that establish this amendment process.

4597.18. Safe harbor agreement; costs.

A participating landowner, in conjunction with the preparation of an application for a working forest management plan filed with the department, may also seek approval of a safe harbor agreement from the Department of Fish and Wildlife, pursuant to Article 3.7 (commencing with Section 2089.2) of Chapter 1.5 of Division 3 of the Fish and Game Code. All review costs associated with the safe harbor agreement approval process incurred by the Department of Fish and Wildlife pursuant to this section shall be paid from the fund created in Section 4629.3.

4597.19. State restoration grant funding not precluded.

Notwithstanding any other law, if a person with a working forest management plan or a nonindustrial timber management plan applies for state restoration grant funding for a restoration project that has a significant public benefit, the application shall not be summarily denied on the basis that the project is a required condition of the harvesting plan.

4597.21. Applicability of county Rules or court decision.

This article does not affect the applicability of county Rules adopted pursuant to Section 4516.5 nor any court decision made by a court of competent jurisdiction.

4597.22. Application of article.

This article does not apply to the Southern Subdistrict of the Coast Forest District, as described in Section 895.1 of Title 14 of the California Code of Regulations.

Article 7.8. Program Timberland Environmental Impact Report for Carbon Sequestration and Fuel Reduction Program.

4598. Legislative findings and declarations.

The Legislature finds and declares all of the following:

(a) In order to meet the goals of the California Global Warming Solutions Act of 2006 (Division 25.5 (commencing with Section 38500) of the Health and Safety Code), it is necessary to increase the carbon sequestration potential of California's Timberlands and to decrease carbon emissions from wildland fires.

(b) Over one-half of the privately owned, commercial Timberland in the state is owned by nonindustrial landowners. These lands will be increasingly important in the state's efforts to meet the goals of the California Global Warming Solutions Act of 2006. The owners of these lands often lack the forestry expertise, economic incentive, or capital needed to make investments to decrease present and future Greenhouse Gas emissions from their lands and the potential for wildland fires that release Greenhouse Gases.

(c) Long-term uneven-aged management of private Timberlands within the state and the retention of large, old trees can increase the ability of Timberlands to sequester carbon through increased growth and inventory and to convert carbon into oxygen through photosynthesis.

(d) Prudent management of Timberlands can decrease the potential for large wildland fires, that release Greenhouse Gases, by creating forests that are less susceptible to ignition and that reduce the intensity of wildland fires, thereby allowing for more successful fire suppression efforts.

(e) Recent Projects have demonstrated the benefits of pursuing program Timberland environmental Impact reports (PTEIRs), which provide better long-term management guidance for forests than single-project timber harvest plans.

(f) The state has an interest in securing the carbon sequestration and fire protection benefits of prudent long-term management of Timberlands owned by nonindustrial landowners.

Z'BERG-NEJEDLY FOREST PRACTICE ACT

4598.1. Purpose of article.

(a) The purpose of this article is to encourage private investments in, and improved long-term management of, Timberlands and resources within the state to promote carbon sequestration through increased timber growth and inventory, reduced carbon emissions from wildland fires by creating fire resiliency on private Timberlands, and the protection, maintenance, and enhancement of a productive and stable forest resource system for the benefit of present and future generations.

(b) The primary emphasis of the program established by this article shall be upon increasing carbon sequestration in Timberlands and reducing carbon emissions from wildland fires. Consistent with this primary emphasis, the program shall also be managed to maintain or improve all forest resources, such as fish and wildlife habitat and soil resources, so that the overall effect of the program is to improve the total forest resource system.

4598.2. Authority of department to enter agreements and make grants.

(a) In furtherance of the purposes of this article, the department may enter into agreements and make grants and take other actions necessary to carry out the purposes of this article.

(b) (1) The PTEIR for carbon sequestration and fuel reduction program conducted by the department shall encourage forest resource improvements and otherwise facilitate good Timberland management through a program of financial and technical assistance to smaller nonindustrial landowners and coalitions of smaller nonindustrial landowners for the development of watershed-specific PTEIRs for watersheds where the primary focus of the contemplated work is reduction of Greenhouse Gases.

(2) The purpose of this program shall be to work cooperatively with public and private landowners, particularly smaller nonindustrial landowners, to upgrade the long-term management of their lands and, thereby improve the ability of their lands to both sequester carbon and to resist wildland fires that cause emissions of carbon.

4598.3. Definitions.

As used in this article, the following terms shall have the following meanings:

(a) "Eligible landowner" means any person who meets the conditions set forth in Sections 4598.6 and 4598.8. Where ownership of Timberland and timber are not held by the same person, "landowner" means either the person or persons owning the land or the person or persons owning the timber.

(b) "Timberland" has the same meaning as defined in Section 4526.

(c) "PTEIR" means a program Timberland environmental Impact report prepared pursuant to this article and Article 6.8 (commencing with Section 1092) of Title 14 of the California Code of Regulations.

(d) "Smaller nonindustrial landowner" means an owner of 5,000 acres or less of Timberland within the state.

4598.4. Authority of director to enter agreements and make grants.

Agreements may be entered into and grants may be made by the director pursuant to this article for the purpose of preparing PTEIRs for Projects that demonstrate potential to increase carbon sequestration, decrease atmospheric carbon levels, and reduce the potential for large wildland fires.

4598.5. Agreements and grants on behalf of eligible landowners.

(a) The director may enter into agreements, on behalf of eligible landowners, pursuant to which the department will undertake the preparation of PTEIRs. The department may enter into agreements with the Department of General Services or third-party consultants to assist in the preparation of PTEIRs.

(b) The department may provide grant funds to eligible landowners in amounts not to exceed the direct costs to the eligible landowners of preparing PTEIRs pursuant to this article.

(c) The department shall pay the costs of preparing the PTEIRs, or provide grant funds to eligible landowners, from funds appropriated to the department from the Greenhouse Gas Reduction Fund, pursuant to Section 39718 of the Health and Safety Code.

Z'BERG-NEJEDLY FOREST PRACTICE ACT

(d) All expenditures made by the department pursuant to this article shall be in a manner consistent with the criteria expressed in Section 39712 of the Health and Safety Code and with the investment plan developed by the Department of Finance pursuant to Section 39716 of the Health and Safety Code.

4598.6. Eligibility for participation in agreement or grant; conditions.

To be eligible for participation in an agreement or grant pursuant to Section 4598.5, the following conditions shall be met:

(a) The application requirements established by the board are satisfied.

(b) The landowner is a smaller nonindustrial landowner, as defined in Section 4598.3. Where the Timberland is owned jointly by more than one individual, group, association, or corporation, as joint tenants, tenants in common, tenants by the entirety, or otherwise, the joint owners shall be considered, for the purposes of this article, as one landowner.

(c) The parcel or parcels of Timberland to which the PTEIR shall apply is either:

(1) Within a timber preserve zone established pursuant to Article 6.7 (commencing with Section 51100) of Part 1 of Division 1 of Title 5 of the Government Code and not the subject of an application for rezoning or immediate rezoning pursuant to Section 51120 of, or Article 4 (commencing with Section 51130) of Chapter 6.7 of Part 1 of Division 1 of Title 5, of the Government Code.

(2) Subject to a contract signed by the landowner in which the landowner agrees not to develop the parcel of Timberland for uses incompatible with the PTEIR within 20 years following the execution of an agreement or the making of a grant pursuant to Section 4598.5. The director shall record the contract in the office of the county recorder in the county in which the parcel of Timberland is located and, upon recordation, the contract shall be binding upon any person to whom the parcel of Timberland is sold, assigned, devised, or otherwise transferred by agreement or operation of law.

4598.7. Payments or grants for work subject to assistance provided by federal law.

Payments or grants pursuant to this article may be made for work that is also the subject of payments or other assistance provided pursuant to federal law. Payments or grants shall not be made pursuant to this article to satisfy landowner cost share requirements of, or repay loans received pursuant to, federal law. The combined state and federal payments or other assistance shall not together exceed the amount of the actual cost of the PTEIR to the landowner.

4598.8. Landowner eligibility requirements.

In addition to the requirements of Section 4598.6, to be eligible to participate in agreements or receive grants pursuant to Section 4598.5, the landowner shall do all of the following:

(a) Submit a proposal to the department detailing the long-term forest and land management plans for approval by the director. The proposal shall set forth an analysis of Timberland conditions and capabilities relative to carbon sequestration and fire resiliency. The proposal shall describe the management objectives and shall provide for all of the following:

(1) Increased direct carbon sequestration through increased growth and inventory and long-term uneven-aged management of the Timberlands.

(2) Improved resistance to wildland fire.

(3) Maintenance of large old trees across the watershed.

(4) Optimized timber growth potential of the Timberland consistent with maintaining carbon additionally over the baseline.

(5) Measurable metrics demonstrating Greenhouse Gas reductions achieved by the long-term management to be analyzed in the PTEIR.

(b) Submit a project application in the form prescribed by the director containing information the board deems necessary to evaluate the PTEIR.

(c) Agree to comply with state or federal laws applicable to the work carried out pursuant to any program timber harvesting plan developed pursuant to a PTEIR.

Z'BERG-NEJEDLY FOREST PRACTICE ACT

(d) Agree to provide to the department, upon completion of each program timber harvesting plan undertaken pursuant to a PTEIR, a report detailing Greenhouse Gas reductions achieved by the plan.

(e) Agree to provide to the department any data or metrics on Greenhouse Gas reductions as required by law.

4598.9. Procedure for promulgating regulations, guidelines, or publications.

To carry out this article and to facilitate participation in the program authorized by this article, the board may promulgate regulations, guidelines, or publications the board deems appropriate. Regulations promulgated by the board may be adopted as emergency regulations. Regulations or emergency regulations adopted pursuant to this section shall be adopted in accordance with the rulemaking provisions of the Administrative Procedure Act (Chapter 3.5 (commencing with Section 11340) of Part 1 of Division 3 of Title 2 of the Government Code). The adoption of emergency regulations shall be deemed an emergency and necessary for the immediate preservation of the public peace, health, and safety, or general welfare. The regulations, guidelines, or publications shall be submitted to the board for review or approval. Regulations, guidelines, or publications shall specify all of the following:

(a) Criteria to determine Timberlands that have demonstrated potential for increased carbon sequestration and fire protection benefits and, therefore, the landowners of those lands may be eligible to enter into agreements or receive grant funds under Section 4598.5.

(b) Guidelines further specifying the scope of Projects for which agreements may be entered into or grants made pursuant to this article.

(c) Factors to be considered and information to be included in proposals submitted pursuant to Section 4598.8.

(d) A standard application form for proposals submitted pursuant to Section 4598.8.

(e) Guidelines for evaluation and approval of proposals to enter into agreements or receive grant funds under Section 4598.5.

(f) Metrics for evaluating the Greenhouse Gas reductions to be achieved by the long-term management of the Timberlands pursuant to the PTEIR.

(g) The form and content of reports detailing Greenhouse Gas reductions as required by Section 4598.8.

(h) Any other matters as the board deems necessary for the effective administration of this article.

Article 8. Penalties and Enforcement.

4601. Penalty.

Any person who willfully violates any provision of this chapter or rule or regulation of the board is guilty of a misdemeanor and shall be punishable by a fine of not more than one thousand dollars (\$1,000) or by imprisonment in the county jail for not more than six months, or by both such fine and imprisonment. The person is guilty of a separate misdemeanor offense under this section for each day in which an order for corrective action issued pursuant to Section 4605 or 4608 is violated.

4601.1. Violation of Chapter; civil penalty; judicial imposition or administrative imposition.

(a) (1) In addition to any other penalty, any person who intentionally, knowingly, or negligently violates this chapter or a rule or regulation adopted by the board pursuant to this chapter is subject to a civil penalty imposed by a court in an amount not to exceed ten thousand dollars (\$10,000) for each violation. For purposes of this section, damage that occurs over multiple days that results from a single action shall not be considered a continuing violation. For purposes of this section, each specific act that results in a violation of this chapter or a rule or regulation adopted pursuant to this chapter, including an act that is repeated on separate days, shall be considered a separate violation.

(2) The Attorney General or district attorney, upon request of the director, shall petition the superior court to impose, assess, and recover a civil penalty pursuant to this subdivision. In determining the appropriate amount, the court shall consider all relevant circumstances, including, but not limited to, persistence, circumstances, extent and gravity of the violation, the length of

Z'BERG-NEJEDLY FOREST PRACTICE ACT

the time over which the violation occurred, whether any substantial damage caused by the violation is susceptible to corrective action, whether the violation was willful or caused by negligence, and, with respect to the violator, the ability of the violator to pay any fines or penalties, the effect on the ability to continue in business, the corrective action, if any, taken by the violator, whether the violator has any prior history of violations, the degree of culpability, economic savings, if any, resulting from the violation, and such other matters as justice may require.

(b) A civil penalty may also be administratively imposed by the department in accordance with Section 4601.2 on any person who intentionally, knowingly, or negligently violates this chapter or a rule or regulation adopted by the board pursuant to this chapter in an amount not to exceed ten thousand dollars (\$10,000) for each violation of a separate provision. For purposes of this section, damage that occurs over multiple days that results from a single action shall not be considered a continuing violation. For purposes of this section, each specific act that results in a violation of this chapter or a rule or regulation adopted pursuant to this chapter, including an act that is repeated on separate days, shall be considered a separate violation.

(c) No person is subject to both a civil penalty imposed by the superior court under subdivision (a) and a civil penalty administratively imposed under subdivision (b) for the same act or failure to act.

(d) Any money recovered by the department pursuant to this section shall be deposited in the General Fund.

4601.2. Administrative civil penalty.

(a) The director may issue a complaint and proposed order to any person on whom an administrative penalty may be imposed pursuant to subdivision (b) of Section 4601.1. The complaint and order shall allege the act or failure to act that constitutes a violation, include a citation to the provisions authorizing the civil penalty to be imposed, and include the proposed civil penalty.

(b) In determining the amount of any administrative civil penalty, the department shall consider all relevant circumstances, including, but not limited to, the extent of harm caused by the violation, the nature, persistence, circumstances, extent and gravity of the violation, the length of time over which the violation occurred, whether any substantial damage caused by the violation is susceptible to corrective action, whether the violation was willful or caused by negligence, and, with respect to the violator, the ability of the violator to pay any fines or penalties, the effect on ability to continue in business, the corrective action, if any, taken by the violator, whether the violator has any prior history of violations, the degree of culpability, economic savings, if any, resulting from the violation, and such other matters as justice may require.

(c) The complaint shall be served by personal notice or certified mail, and shall inform the party so served that, upon the request of the party made within 10 days of such service, a hearing shall be conducted before the board or an administrative law judge within 180 days from the date that the party is served. The chairperson of the board may delegate the conduct of the hearing to a committee of the board, which shall be composed of at least three members of the board, or elect to utilize an administrative law judge assigned in accordance with Section 11370.3 of the Government Code. If the chairperson delegates the matter to a committee of the board, a majority of the committee members shall not have a financial interest in the forest products or range industry. The committee may exercise any power the board may exercise.

(d) The party charged with a violation may waive a right to a hearing, in which case the board shall not conduct a hearing, and the order of the director shall become final.

(e) After a hearing, the board or an administrative law judge may adopt, with or without revision, the proposed order of the director.

(f) An order setting an administrative civil penalty shall become effective and final upon its adoption pursuant to subdivision (e), and any payment shall be made within the time period provided by subdivision (b) of Section 4601.3. Copies of the order shall be served by personal service or by registered mail upon the party served with the complaint and upon other persons who appeared at the hearing and requested a copy.

4601.3 Judicial review.

Z'BERG-NEJEDLY FOREST PRACTICE ACT

(a) Any party who is aggrieved by a final order issued by the board or an administrative law judge under Section 4601.2 may obtain review of the order in the superior court in the county in which the violation occurred by filing a petition for a writ of mandate with the court within 30 days from the date of service of the order on the party. If the aggrieved party does not petition for a writ of mandate within that 30-day period, the order of the board or an administrative law judge is not thereafter subject to review by any court.

(b) After the time for judicial review has expired, or where the party has not requested a review of the order, the administrative penalty shall be due and payable to the department within 20 days. The department may apply to the clerk of the appropriate court in the county in which the civil penalty was imposed for a judgment to collect the penalty. The application, which shall include a certified copy of the action by the board or the administrative law judge, constitutes a sufficient showing to warrant issuance of the judgment to collect the penalty. The court clerk shall enter the judgment in conformity with the application. Any judgment so entered by the court clerk shall have the same force and effect as, and is subject to the laws relating to, a judgment in a civil action, and may be enforced in the same manner as any other judgment of the court in which it is entered.

4601.4 Violation of rule or regulation not resulting in environmental damage; infraction.

(a) The violation of any rule or regulation adopted by the board pursuant to this chapter prescribing any procedural requirement that does not result in, or cause, any environmental damage, and is not a violation of Section 4571 or 4581, is an infraction punishable pursuant to Section 4601.5.

(b) The board shall designate those Rules and regulations by section number that prescribe procedural requirements, the violation of which does not result in, or cause, environmental damage.

4601.5 Fines for infractions; correctable violations.

(a) Any person who violates a rule or regulation of the board, the violation of which is an infraction as described in Section 4601.4, shall, upon conviction of the infraction, pay a fine in accordance with the following schedule:

(1) A fine of one hundred dollars (\$100) shall be imposed for the first conviction of an infraction.

(2) A fine of two hundred fifty dollars (\$250) shall be imposed for a second or subsequent conviction for the same violation within a three-year period.

(b) The board may provide, by regulation, that certain violations of a rule or regulation that would constitute an infraction, if prosecuted, are correctable and not subject to prosecution, if the violation is corrected within 10 working days from the date of the violation.

4602.5. Temporary suspension of operations pending judicial remedies; procedures; violations; penalties.

(a) This section provides an administrative procedure to suspend Timber Operations temporarily while judicial remedies are pursued pursuant to this article.

(b) An inspecting forest officer may issue a written Timber Operations stop order if, upon reasonable cause, the officer determines that a timber operation is being conducted or is about to be conducted in violation of this chapter or of forest practice Rules adopted by the board pursuant to this chapter and that the violation or threatened violation would result in imminent and substantial harm to soil, water, or timber resources, or to fish and wildlife habitat. A stop order shall apply only to those acts or omissions that are the proximate cause of the violation or threatened violation. The stop order shall be effective immediately and throughout the next day.

(c) A supervising forest officer may, after an onsite investigation, extend a stop order issued pursuant to subdivision (b) for up to five days, excluding Saturday and Sunday, provided that the supervising forest officer finds that the original stop order was issued upon reasonable cause. A stop order shall not be issued or extended for the same act or omission more than one time.

(d) Each stop order shall identify the specific act or omission that constitutes the violation or threatened violation, any timber operation that is to be stopped, and any corrective or mitigative

Z'BERG-NEJEDLY FOREST PRACTICE ACT

actions that may be required. The department may terminate the stop order if the responsible parties enter into a written agreement with the department assuring that the parties will resume operations in compliance with this chapter and the Rules adopted by the board and will correct the violations. The department may require a reasonable cash deposit or bond payable to the department as a condition of compliance with the agreement.

(e) Notice of the issuance of a stop order or an extension of a stop order shall be deemed to have been made to all persons working on a timber operation when a copy of the written order is delivered to the person in charge of operations at the time the order is issued or, if no persons are present at that time, then by posting a copy of the order conspicuously on the yarder or log loading equipment at a currently active Landing on the Timber Operations. If no persons are present at the site of the timber operation when the order is issued, the issuing officer shall deliver a copy of the order to the Timber Operator either in person or to the operator's address of record prior to the commencement of the next working day.

(f) As used in this section, "forest officer" means a registered professional forester employed by the department in a civil service classification of forester II or higher grade.

(g) Failure of the Timber Operator or an employee of the Timber Operator, after receiving notice, to comply with a stop order is a violation of this chapter and is punishable as provided in Section 4601; provided, however, that in all cases the Timber Operator, and not another person or the employee, shall be charged with this violation. In determining the penalty for any Timber Operator found guilty of violating a validly issued stop order, the court shall take into consideration all relevant circumstances, including, but not limited to, the following:

(1) The extent of harm to soil, water, or timber resources or to fish and wildlife habitat.

(2) Corrective action, if any, taken by the defendant. Each day or portion thereof that the violation continues shall constitute a new and separate offense.

(h) This section does not prevent a timber operator from seeking an alternative writ as prescribed in Chapter 2 (commencing with Section 1084) of Title 1 of Part 3 of the Code of Civil Procedure, or as provided by any other law.

4602.6. Temporary suspension of operations pending judicial remedies; lack of reasonable cause; claim against public entities; amount of damages.

(a) If a Timber Operator believes that a forest officer lacked reasonable cause to issue or extend a stop order pursuant to Section 4602.5, the Timber Operator may present a claim to the Department of General Services pursuant to Part 3 (commencing with Section 900) of Division 3.6 of Title 1 of the Government Code for compensation and damages resulting from the stopping of Timber Operations.

(b) If the Department of General Services finds that the forest officer lacked reasonable cause to issue or extend the stop order, the department shall award a sum of not less than one hundred dollars (\$100) nor more than one thousand dollars (\$1,000) per day for each day the order was in effect.

4603. Action to enforce compliance.

The Attorney General may, on his or her own motion or at the request of the board, bring an action to enforce compliance with the Rules and regulations of the board and this chapter.

4604. Inspection of timber operation; periodic inspections; operative date.

(a) The department shall provide an initial inspection of the area in which Timber Operations are to be conducted within 10 days from the date of filing of the timber harvesting plan or nonindustrial timber management plan, or a longer period as may be mutually agreed upon by the department and the person submitting the plan, except that the inspection need not be made pursuant to the filing of a timber harvesting plan if the department determines that the inspection would not add substantive information that is necessary to enforce this chapter. The department shall provide for inspections, as needed, as follows:

(1) During the period of commencement of Timber Operations.

(2) When Timber Operations are well under way.

(3) Following completion of Timber Operations.

Z'BERG-NEJEDLY FOREST PRACTICE ACT

(4) At any other times as deemed necessary to enforce this chapter.

(b) (1) The Department of Fish and Game, the California regional water quality control boards, or the State Water Resources Control Board, if accompanied by Department of Forestry and Fire Protection personnel and after 24-hour advance notification is given to the landowner, may enter and inspect land during normal business hours at any time after commencement of timber harvest plan activities on the land and before the director issues a report of satisfactory completion of stocking pursuant to Section 4588 or at any time before the end of the first winter period following the filing of a work completion report pursuant to Section 4585, whichever is later. Any member of the inspection party may utilize whatever measurement and evaluation devices, including, but not limited to, photographic equipment and temperature measurement devices, that are determined to be necessary, when participating in an inspection of an area pursuant to subdivision (a) or after commencement of timber harvesting plan activities pursuant to this subdivision.

(2) Photographs taken during inspections shall be clearly labeled as to time, date, and location and shall be the property of the department and part of the inspection record. The inspection record shall be subject to all provisions of the California Public Records Act (Division 10 (commencing with Section 7920.000) of Title 1 of the Government Code).

(3) This subdivision is not a limitation upon the authority of any agency to inspect pursuant to any other provision of law.

(c) This section shall become operative on January 1, 1991, or on the effective date of the Rules and regulations adopted by the State Board of Forestry and Fire Protection pursuant to Senate Bill 1566 (Stat. 1989, ch. 1290), whichever date occurs first.

4605. Action to enjoin violations; temporary restraining order.

The department may bring an action to enjoin the violation, or threatened violation, of any provision of this chapter or the Rules and regulations of the board. Any such proceedings shall be in accordance with the provisions of Chapter 3 (commencing with Section 525) of Title 7 of Part 2 of the Code of Civil Procedure. If in such a proceeding it shall appear from facts shown by affidavit or verified complaint that any such violation has occurred or is threatened, the court may issue a temporary restraining order restraining and ordering the immediate discontinuance of any timber operation in which such violation has occurred or is threatened pending a hearing on the matter.

The court may, upon a finding that immediate and irreparable harm is threatened to soil resources or the water of the state by virtue of erosion, pollution, or contamination, order the defendant to take appropriate emergency corrective action, authorize the department to order the defendant to take such action, or authorize the department to take emergency action to correct a violation of this chapter. Any expenses incurred by the department in taking action in conformity with such order shall be a lien upon the property upon which such action was taken when notice of the lien is recorded. Such lien shall be subject to the provisions of Section 4608.

4606. Form of injunctive relief; bond.

If upon a hearing to show cause why a preliminary injunction should not be issued, or upon a hearing of any motion for a preliminary injunction, or if the court should find in any such action that any such defendant is violating, threatens to violate, or has violated, any provision of this chapter or Rules and regulations of the board, the court may not only order the discontinuance of any Timber Operations in which the violation has occurred, is threatening to occur, or is occurring, but may also enjoin any further Timber Operations by the defendant in this state until the violations complained of have been corrected or until satisfactory provisions have been approved by the court for the violations to be corrected at a specified date. Any defendant in such proceedings may enter into a written agreement with the department assuring that such defendant will resume operations in compliance with the provisions of this chapter or the Rules and regulations of the board and correct the violations on such reasonable terms and conditions as the department may require. Upon approval by the court, any temporary restraining order, preliminary injunction, or permanent injunction may include or be amended to include an order that any defendant entering into such an agreement comply with the terms of the agreement as a condition for engaging in any Timber

Z'BERG-NEJEDLY FOREST PRACTICE ACT

Operations enjoined by the temporary restraining order, preliminary injunction, or permanent injunction. The court may require a bond payable to the department in such amount as the court deems proper to insure correction of any such violation in accordance with the agreement or any other provisions required by the court. The court may make any other orders reasonable and necessary to carry out the intent of this article.

4607. Correction of violations; expenses.

The department may take such appropriate steps as are necessary and incur expenses to correct any violation.

4608. Notice of corrective action; form; contents; service; lien.

(a) Before taking any corrective action, other than under Section 4605, the department shall serve a written notice upon the person responsible for the violation. The notice shall include a statement of the corrective action to be taken, a date not less than 30 days from the date of service of the notice by which the corrective action is to be taken, and a statement that if the corrective action is not taken on or before the date specified the department may take corrective action and charge the person for the costs of the corrective action pursuant to Section 4610. The notice shall also include a statement that if the person disagrees for any reason with the proposed corrective action or with the charging of the person with the costs of the corrective action, the person may, within 10 days from the service of the notice, request of the board a public hearing before the board.

(b) The department may record the notice in each county where the land in violation is situated, together with a statement that any and all expenses incurred by the department in taking corrective action pursuant to this article shall be a lien against the land. Upon satisfactory proof that corrective action has been completed, the department shall record a notice to that effect.

(c) Any expenses incurred by the department in taking corrective action shall be a lien upon the real property upon which the action was taken when notice of the lien is recorded. Notice of the lien, particularly identifying the real property upon which the action was taken and the amount of the lien and naming the owner of the property, shall be recorded by the department, in the office of the county recorder of each county in which the property is situated within one year after the first item of expenditures by the department or within 90 days after the completion of the action, whichever first occurs. Upon the recording, the lien shall have the same force, effect, and priority as a judgment lien, except that it shall attach only to the real property described in the notice and shall continue for 10 years from the time of the recording of the notice, unless sooner released or otherwise discharged. The lien may, within 10 years of the time of the recording, or within 10 years from the date of the last extension of the lien in the manner herein provided, be extended by recording a new notice in the office of the county recorder where the original notice is recorded, and from the time of the recording the lien shall be extended as to the real property for 10 years, unless sooner released or otherwise discharged. The department may at any time release all or any portion of the real property subject to the lien from the lien or subordinate it to other liens and encumbrances, if it determines that the amount owed is sufficiently secured by a lien on other property or that the release or subordination of the lien will not jeopardize the collection of the amount owed. A certificate by the department to the effect that any real property has been released from the lien or that the lien has been subordinated to other liens and encumbrances shall be conclusive evidence that the real property has been released or that the lien has been subordinated as provided in the certificate.

4609. Action upon noncompliance with notice; public hearing by board; order.

If the corrective action is not taken on or before the date specified in the notice served pursuant to Section 4608, the department may take, or contract for the taking of, such corrective action and recover the expenses of the corrective action as provided in Section 4610. When the person responsible makes a request for public hearing, the board, after at least 15 days written notice, shall hold a public hearing to hear the objections to the proposed action. The board may, but need not, conduct the hearing in accordance with the applicable provisions of Chapter 5 (commencing with Section 11500) of Part 1 of Division 3 of Title 2 of the Government Code. At the conclusion of the

Z'BERG-NEJEDLY FOREST PRACTICE ACT

hearing, the board may make an order specifying the action to be taken by the person responsible to correct the violation, setting the time limits for such action, and authorizing the taking of such action by the department if the person responsible does not do so within the specified time.

4610. Expenses of corrective action; debt of person responsible; collection.

The expenses incurred by the department in taking any corrective action pursuant to this article shall be increased by two hundred fifty dollars (\$250) or 10 percent, whichever sum is higher, as administrative costs and shall constitute a debt of the person responsible, and, if not paid within 10 days after written demand therefore, may be recovered by the department in a civil action.

4611. Entry upon land to take corrective action; civil liability.

Neither the board, the department, nor any person authorized by the board or the department to enter upon any lands for the purpose of taking any corrective action pursuant to this article is liable to civil action for trespass for any acts which are necessary to carry out the provisions of this article.

Article 9. Conversion

4621. Application for conversion; procedure, form, fees and content to be prescribed.

(a) A person who owns Timberlands that are to be devoted to uses other than the growing of timber shall file an application for conversion with the board. The board shall, by regulation, prescribe the procedures for, and the form and content of, the application. An application for a Timberland Conversion Permit shall be accompanied by an application fee, payable to the department, in an amount determined by the board pursuant to subdivision (b).

(b) The board shall establish, by regulation, a system of graduated Timberland Conversion Permit fees to finance the cost of administering this article.

(c) For purposes of this section, "growing of timber" shall include restoration and conservation forest management activities, which may include the removal of commercial species, if necessary to achieve specific forest health and ecological goals, including the restoration and conservation of oak woodlands, grasslands, wet meadows, and other ecologically important or unique habitats, that are not conducted in conjunction with the cutting or removal of trees or other forest products during the conversion of Timberlands for other uses, including, but not limited to, residential or commercial developments, production of other agricultural crops, recreational developments, ski developments, water development Projects, and transportation Projects.

4621.2. Proposed alternate use; information; findings required for approval.

(a) If the Timberlands which are to be devoted to uses other than the growing of timber are zoned as Timberland production zones under Section 51112 or 51113 of the Government Code, the application shall specify the proposed alternate use and shall include information the board determines necessary to evaluate the proposed alternate use. The board shall approve the application for conversion only if the board makes written findings that all of the following exist:

(1) The conversion would be in the public interest.

(2) The conversion would not have a substantial and unmitigated adverse effect upon the continued timber-growing use or open-space use of other land zoned as Timberland production and situated within one mile of the exterior boundary of the land upon which immediate rezoning is proposed.

(3) The soils, slopes, and watershed conditions would be suitable for the uses proposed if the conversion were approved.

(b) The existence of an opportunity for an alternative use of the land shall not alone be sufficient reason for conditionally approving an application for conversion. Conversion shall be considered only if there is no proximate and suitable land which is not zoned as Timberland production for the alternate use not permitted within a Timberland production zone.

(c) The uneconomic character of the existing use shall not be sufficient reason for the conditional approval of conversion. The uneconomic character of the existing use may be considered only if

Z'BERG-NEJEDLY FOREST PRACTICE ACT

there is no other reasonable or comparable timber-growing use to which the land may be put.

(d) In the event that the board delegates its responsibilities under this section to the director pursuant to Section 4627, the director shall make the written findings required by subdivision (a). In the event that the director denies a conversion, the applicant may request a hearing before the board within 15 days of the denial. The hearing shall be scheduled within 60 days from the filing of the appeal.

4622. Conditions for approval of application.

Approval of an application for conversion shall be conditioned upon the granting of the necessary rezoning or use permit if rezoning or a use permit is required. Except as provided in Section 4584, all timber shall be cut pursuant to an approved conversion pursuant to Section 4581, excluding requirements for stocking and methods of silviculture, except that the timber harvesting plan required by that section need not be prepared by a registered professional forester, and no Timber Operations shall commence until the granting of such rezoning or use permit as may be required and until the Timberland Conversion Permit is recorded in the county recorder's office in each county wherein the Timberland to be converted is located.

4623. Affidavit of intent to convert land; additional proof of intent.

The application shall be accompanied by an affidavit by the applicant that the applicant has a present bona fide intent to convert the land to a use other than timber growing. The board may require such additional proof of intent to convert as it deems necessary.

4624. Denial of Conversion Permit; reasons.

The board shall deny a Timberland Conversion Permit for any of the following reasons:

- (a) The applicant is not the real person in interest.
- (b) Material misrepresentation or false statement in the application.
- (c) The applicant does not have a bona fide intention to convert the land.
- (d) The failure or refusal of the applicant to comply with the Rules and regulations of the board and the provisions of this chapter.
- (e) The failure of the proposed alternate use in the application to meet the findings required in subdivision (a) of Section 4621.2 and other provisions of that section.

4624.5. Hearing on denial of permit.

A person whose application for a Timberland Conversion Permit has been denied shall be entitled to a hearing before the board pursuant to Chapter 5 (commencing with Section 11500) of Part 1 of Division 3 of Title 2 of the Government Code.

4625. Approval of application for permit.

If the board finds the applicant does have a bona fide intention to convert the land, it shall approve the application, authorizing the applicant to cut and remove any and all trees, provided that the applicant otherwise complies with this chapter.

4626. Revocation of permit.

If at any time the board finds that the applicant has failed to conform to the intent to convert, as set forth in the application and proof, the board may revoke the permit and require full compliance with this chapter. Any permit revocation shall be recorded in the same manner as the original permit.

4627. Delegation of authority.

The board may, by regulation, delegate its authority and responsibilities under this article to the director if it determines that the director can more efficiently exercise such authority and carry out such responsibilities.

4628. Exemptions from regulations; right-of-way construction or maintenance; subdivision development.

Z'BERG-NEJEDLY FOREST PRACTICE ACT

(a) Notwithstanding any provision of this article or of Section 4581, no public agency shall be required to submit a timber harvesting plan or file an application for conversion with the board where the purpose of its Timber Operations is to construct or maintain a right-of-way on its own or on any other public property.

(b) Removal of trees for subdivision development, except on lands zoned as a Timberland production zone pursuant to Section 51112 or 51113 of, and as defined in subdivision (g) of Section 51104, of the Government Code, where the subdivision has had a tentative subdivision map approved and a subdivision use permit granted by the city or county having jurisdiction, may be exempted by regulation from the provisions of this article, if the exemption is consistent with the purposes of this chapter.

Article 9.5. Timber Regulation and Forest Restoration Fund.

4629. Legislative findings and declarations.

The Legislature finds and declares all of the following:

(a) A thriving in-state forest products sector provides public benefits, including employment opportunities in both rural and urban areas, and economic development for rural communities.

(b) Enabling continued economically viable production of forest products can help to protect the state's forest lands from conversion to other uses.

(c) The state's forest practice regulations provide for environmental protection of the state's air, water, habitat, and soil resources.

(d) Consumers of wood products in the state currently do not directly pay for the state's forest practice program and the costs of protecting the state's natural resources.

(e) Current in-state producers of wood products already bear a significant cost of conforming with the state's environmental laws, which economically disadvantages those producers relative to out-of-state production.

(f) Conforming with the state's environmental laws ensures that wildlife, habitat, clean air, forest, and water quality receive some protection.

4629.1. Additional legislative findings regarding the state's forest practice regulatory program.

The Legislature further finds that the state's forest practice regulatory program needs to develop adequate performance measures to provide transparency for both the regulated community and other stakeholders.

4629.2. Legislative intent; purpose of article.

In enacting this article, it is the intent of the Legislature to accomplish all of the following:

(a) Promote and encourage sustainable forest practices consistent with provisions of this chapter in a manner consistent with other laws, including, but not limited to, the Timberland Productivity Act of 1982 (Article 1 (commencing with Section 51100) of Chapter 6.7 of Part 1 of Division 1 of Title 5 of the Government Code), the California Environmental Quality Act (Division 13 (commencing with Section 21000)), the Porter-Cologne Water Quality Act (Chapter 1 (commencing with Section 13000) of Division 7 of the Water Code), and the California Endangered Species Act (Article 3 (commencing with Section 2080) of Chapter 1.5 of Division 3 of the Fish and Game Code).

(b) Ensure continued sustainable funding for the state's forest practice program to protect the state's forest resources, and replace the current piecemeal funding structure with a single funding source.

(c) Support in-state production of timber within the state's environmental standards, and promote and encourage retention of forests and forested landscapes.

(d) Create a funding source for the restoration of the state's forested lands and promote restoration of fisheries and wildlife habitat and improvement in water quality.

Z'BERG-NEJEDLY FOREST PRACTICE ACT

(e) Promote restoration and management of forested landscapes consistent with the California Global Warming Solutions Act of 2006 (Division 25.5 (commencing with Section 38500) of the Health and Safety Code).

(f) Promote transparency in regulatory costs and programs through the creation of performance measures and accountability for the state's forest practice regulatory program and simplify the collection and use of critical data to ensure consistency with other pertinent laws and regulations.

(g) Identify and implement efficiencies in the regulation of timber harvesting between state agencies.

(h) Modify current regulatory programs to incorporate, and provide incentives for best practices, and develop standards or strategies, where appropriate, to protect natural resources, including the development of plans that address road management and Riparian function on an ownershipwide, watershedwide, or districtwide scale.

4629.3. Timber Regulation and Forest Restoration Fund; creation deposit of funds; definitions.

(a) The Timber Regulation and Forest Restoration Fund is hereby created in the State Treasury. All revenues received from the assessments imposed pursuant to Section 4629.5, less amounts deducted for refunds and reimbursements, shall be deposited into the fund.

(b) Unless the context requires otherwise, the following definitions shall apply to this article:

(1) "Board" means the State Board of Forestry and Fire Protection.

(2) "Department" means the Department of Forestry and Fire Protection.

(3) "Engineered wood product" means a building product, including, but not limited to, veneer-based sheeting material, plywood, laminated veneer lumber (LVL), parallel-laminated veneer (PLV), laminated beams, I-joists, edge-glued material, or composite material such as cellulosic fiberboard, hardboard, decking, particleboard, waferboard, flakeboard, oriented strand board (OSB), or any other panel or composite product where wood is a component part, that is identified in regulations adopted by the board pursuant to Section 4629.4. For purpose of this paragraph, an "engineered wood product" shall only include products that consist of at least 10 percent wood.

(4) "Fund" means the Timber Regulation and Forest Restoration Fund.

(5) "Lumber product" means a product in which wood or wood fiber is a principal component part, including, but not limited to, a solid wood product, or an engineered wood product, that is identified in regulations adopted by the board pursuant to Section 4629.4. "Lumber product" does not include furniture, paper products, indoor flooring products such as hardwood or laminated flooring, bark or cork products, firewood, or other products not typically regarded as lumber products.

(6) "Principal component part" means 10 percent of the total content by volume.

(7) "Qualified nonprofit organization" means any nonprofit public benefit corporation formed pursuant to the Nonprofit Corporation Law (Division 2 (commencing with Section 5000) of Title 1 of the Corporations Code) qualified to do business in California and qualified for exempt status under Section 501(c)(3), 501(c)(4), or 501(c)(5) of the Internal Revenue Code.

(8) "Recognized tribe" means those entities recognized as eligible to receive service from the United States Bureau of Indian Affairs, as listed in the Federal Register, and those tribes designated in the list of non-recognized tribes for California by the Native American Heritage Commission.

(9) "State responsibility area" means those areas for which the state has primary fire protection responsibility, as designated by the board in accordance with Section 4125.

4629.4. Adoption of regulation regarding lumber products and engineered wood products subject to lumber products assessment; annual update; adoption of additional regulations or emergency regulations.

(a) On or before October 1, 2012, the board shall adopt a regulation that interprets and makes specific the lumber products and engineered wood products that the board determines shall be subject to the lumber products assessment imposed pursuant to Section 4629.5. The board shall annually update the regulation. The lumber products identified in the annually updated regulation

Z'BERG-NEJEDLY FOREST PRACTICE ACT

that is adopted shall become subject to the assessment imposed pursuant to Section 4629.5 on the first day of the calendar quarter commencing more than 60 days after adoption of the updated regulation.

(b) The board shall adopt any regulations or emergency regulations necessary to implement the provisions of this article in accordance with the rulemaking provisions of the Administrative Procedure Act (Chapter 3.5 (commencing with Section 11340) of Part 1 of Division 3 of title 2 of the Government Code). The board may readopt any emergency regulation authorized by this section that is the same as or substantially equivalent to an emergency regulation previously adopted under this section. The initial adoption of emergency regulations and the one readoption of emergency regulations authorized by this subdivision shall be deemed an emergency and necessary for the immediate preservation of the public peace, health and safety, or general welfare. The initial emergency regulation and the one readoption of an emergency regulation authorized by this section shall be exempt from review by the Office of Administrative Law. The initial emergency regulation and the one readoption of an emergency regulations authorized by this section shall be submitted to the Office of Administrative Law for filing with the Secretary of State and each shall remain in effect for no more than 180 days, by which time final regulations may be adopted. The lumber products and engineered wood products identified in the regulation adopted shall become subject to the assessment imposed pursuant to Section 4629.5, commencing January 1, 2013.

4629.5. Lumber products assessment; imposition, administration, and collection; regulations; regulations; registration by persons required to pay assessment.

(a) (1) There is hereby imposed an assessment on a person who purchases a lumber product or an engineered wood product for storage, use, or other consumption in this state, at the rate of 1 percent of the sales price.

(2) A retailer shall charge the person the amount of the assessment as a charge that is separate from, and not included in, any other fee, charge, or other amount paid by the purchaser.

(3) The retailer shall collect the assessment from the person at the time of sale, and may retain reimbursement pursuant to Sections 2000 and 2001 of Title 18 of the California Code of Regulations, as approved by the State Board of Equalization at its September 10, 2013, meeting, for startup costs associated with the collection of the assessment, to be taken on the first return or next consecutive returns until the entire reimbursement amount is retained.

(b) The retailer shall separately state the amount of the assessment imposed under this section on the sales receipt given by the retailer to the person at the time of sale.

(c) The State Board of Equalization shall administer and collect the assessment imposed by this section pursuant to the Fee Collection Procedures Law (Part 30 (commencing with Section 55001) of Division 2 of the Revenue and Taxation Code) with those changes as may be necessary to conform to this article. For purposes of this section, the references in the Fee Collection Procedures Law to "fee" shall include the assessment imposed by this section, and references to "feepayer" shall include a person required to pay the assessment imposed by this article, which includes the retailer.

(d) (1) The assessment is required to be collected by a retailer and any amount unreturned to the person who paid an amount in excess of the assessment, but was collected from the person under the representation by the retailer that it was owed as an assessment, constitutes debts owed by the retailer to this state.

(2) A person who purchases a lumber product or an engineered wood product for storage, use, or other consumption in this state is liable for the assessment until it has been paid to this state, except that payment to a retailer relieves the person from further liability for the assessment. Any assessment collected from a person that has not been remitted to the State Board of Equalization shall be a debt owed to the state by the retailer required to collect and remit the assessment. This part does not impose any obligation upon a retailer to take any legal action to enforce the collection of the assessment imposed by this section.

(3) An excluded retailer, as described in subparagraph (B) of paragraph (2) of subdivision (g), shall provide a notice to a purchaser of qualified lumber products or engineered wood products

Z'BERG-NEJEDLY FOREST PRACTICE ACT

regarding the purchaser's obligation to remit the assessment to the State Board of Equalization. Section 4601 does not apply to this paragraph.

(e) Except as provided in paragraph (3) of subdivision (a), the State Board of Equalization may prescribe, adopt, and enforce regulations relating to the administration and enforcement of this section, including, but not limited to, collections, reporting, refunds, and appeals.

(f) (1) The assessment imposed by this section is due and payable to the State Board of Equalization quarterly on or before the last day of the month next succeeding each quarterly period.

(2) On or before the last day of the month following each quarterly period, a return for the preceding quarterly period shall be filed with the State Board of Equalization using electronic media, in the form prescribed by the State Board of Equalization. Returns shall be authenticated in a form or pursuant to methods, as prescribed by the State Board of Equalization.

(g) For purposes of this section, all of the following shall apply:

(1) "Purchase" has the same meaning as that term is defined in Section 6010 of the Revenue and Taxation Code.

(2) (A) "Retailer" has the same meaning as that term is defined in Section 6015 of the Revenue and Taxation Code.

(B) A retailer with de minimis sales of qualified lumber products and engineered wood products of less than twenty-five thousand dollars (\$25,000) during the previous calendar year is not a retailer for purposes of this section, except as provided in paragraph (3) of subdivision (d).

(3) "Sales price" has the same meaning as that term is defined in Section 6011 of the Revenue and Taxation Code.

(4) "Storage" has the same meaning as that term is defined in Section 6008 of the Revenue and Taxation Code.

(5) "Use" has the same meaning as that term is defined in Section 6009 of the Revenue and Taxation Code.

(h) (1) A person required to pay the assessment imposed under this article shall register with the State Board of Equalization. Every application for registration shall be made in a form prescribed by the State Board of Equalization and shall set forth the name under which the applicant transacts or intends to transact business, the location of the person's place or places of business, and any other information that the State Board of Equalization may require. An application for registration shall be authenticated in a form or pursuant to methods as may be prescribed by the State Board of Equalization.

(2) An application for registration filed pursuant to this section may be filed using electronic media as prescribed by the State Board of Equalization.

(3) Electronic media includes, but is not limited to, computer modem, magnetic media, optical disc, facsimile machine, or telephone.

4629.6. Expenditure of appropriated moneys.

Moneys deposited in the fund shall, upon appropriation by the Legislature, only be expended for the following purposes:

(a) To reimburse the State Board of Equalization for its administrative costs associated with the administration, collection, audit, and issuance of refunds related to the lumber products and engineered wood assessment established pursuant to Section 4629.5.

(b) To pay refunds issued pursuant to Part 30 (commencing with Section 55001) of Division 2 of the Revenue and Taxation Code.

(c) To support the activities and costs of the department, the Department of Conservation, the Department of Fish and Wildlife, the State Water Resources Control Board, and regional water quality control boards associated with the review of Projects or permits necessary to conduct Timber Operations. On or after July 1, 2013, except for fees applicable for fire prevention or protection within state responsibility area classified lands or timber yield assessments, no currently authorized or required fees shall be charged by the agencies listed in this subdivision for activities or costs

Z'BERG-NEJEDLY FOREST PRACTICE ACT

associated with the review of a project, inspection and oversight of Projects, and permits necessary to conduct Timber Operations of those departments and boards.

(d) For transfer to the department's Forest Improvement Program, upon appropriation by the Legislature, for forest resources improvement grants and Projects administered by the department pursuant to Chapter 1 (commencing with Section 4790) and Chapter 2 (commencing with Section 4799.06) of Part 2.5 of Division 4.

(e) To fund existing restoration grant programs, with priority given to the Fisheries Restoration Grant Program administered by the Department of Fish and Wildlife and grant programs administered by state conservancies.

(f) (1) As a loan to the Department of Fish and Wildlife for activities to address environmental damage occurring on forest lands resulting from marijuana cultivation. Not more than five hundred thousand dollars (\$500,000) may be loaned from the fund in a fiscal year pursuant to this paragraph. This paragraph shall become inoperative on July 1, 2017.

(2) Any funds deposited into the Timber Regulation and Forest Restoration Fund pursuant to subdivision (d) or (f) of Section 12025 or subdivision (b), (c), (e), or (f) of Section 12025.1 of the Fish and Game Code shall be credited toward loan repayment.

(3) Moneys from the General Fund shall not be used to repay a loan authorized pursuant to this subdivision.

(g) To the department, upon appropriation by the Legislature, for fuel treatment grants and Projects pursuant to authorities under the Wildland Fire Protection and Resources Management Act of 1978 (Article 1 (commencing with Section 4461) of Chapter 7 of Part 2 of Division 4).

(h) To the department, upon appropriation by the Legislature, to provide grants to local agencies responsible for fire protection, qualified nonprofits, recognized tribes, local and state governments, and resources conservation districts, undertaken on a state responsibility area (SRA) or on wildlands not in an SRA that pose a threat to the SRA, to reduce the costs of wildland fire suppression, reduce Greenhouse Gas emissions, promote adaptation of forested landscapes to changing climate, improve forest health, and protect homes and communities.

4629.7. Grants; priority of activities to be funded.

All grants made pursuant to subdivisions (g) and (h) of Section 4629.6 shall fund activities that do any of the following, in order of priority:

(a) Improve forest health.

(b) Promote climate mitigation strategies included in the California Global Warming Solutions Act of 2006 (Division 25.5 (commencing with Section 38500) of the Health and Safety Code) scoping plan for the forest sector, as adopted by the State Air Resources Control Board, or as amended through subsequent actions of that board.

(c) Promote climate change adaptation strategies for the forest sector, as adopted by the Natural Resources Agency in the California Climate Adaptation Strategy.

4629.8. Appropriation of funds; priorities.

(a) Funds deposited in the Timber Regulation and Forest Restoration Fund shall be appropriated in accordance with the following priorities:

(1) First priority shall be for funding associated with the administration and delivery of responsibilities identified in subdivisions (a) to (c), inclusive, of Section 4629.6.

(2) Only after paragraph (1) is funded, the second priority shall be, if deposits are sufficient in future years to maintain the fund, by 2016, at a minimum reserve of four million dollars (\$4,000,000), for use and appropriation by the Legislature in years during which revenues to the account are projected to fall short of the ongoing budget allocations for support of the activities identified in paragraph (1).

(3) Only after paragraphs (1) and (2) are funded, the third priority shall be in support of activities designated in subdivisions (d), (e), and (f) of Section 4629.6.

(4) Only after paragraphs (1), (2), and (3) are funded, the fourth priority shall be to support the activities designated in subdivisions (g) and (h) of Section 4629.6.

Z'BERG-NEJEDLY FOREST PRACTICE ACT

(b) Funds shall not be used to pay for or reimburse any requirements, including mitigation of a project proponent or applicant, as a condition of any permit.

4629.9. Annual submission of report on forest and Timberland regulation to Joint Legislative Budget Committee.

(a) On or before January 10, 2013, and on each January 10 thereafter in conjunction with the 2014–15 Governor's Budget and each Governor's Budget thereafter, the Secretary of the Natural Resources Agency, in consultation with the Secretary for Environmental Protection, shall submit to the Joint Legislative Budget Committee a report on the activities of all state departments, agencies, and boards relating to forest and Timberland regulation. This report shall include, at a minimum, all of the following:

(1) A listing, by organization, of the proposed total costs associated with the review, approval, and inspection of timber harvest plans and associated permits.

(2) The number of timber harvest plans, and acreage covered by the plans, reviewed in the 2011–12 fiscal year, or the most recent fiscal year.

(3) To the extent feasible, a listing of activities, personnel, and funding, by department, for the forest practice program for 2012–13, or the most recent fiscal year, and the preceding 10 fiscal years.

(4) The number of staff in each organization dedicated fully or partially to (A) review of timber harvest plans, and (B) other forestry-related activities, by geographical location in the state.

(5) The costs of other forestry-related activities undertaken.

(6) A summary of any process improvements identified by the administration as part of ongoing review of the timber harvest process, including data and technology improvement needs.

(7) Workload analysis for the forest practice program in each organization.

(8) In order to assess efficiencies in the program and the effectiveness of spending, a set of measures for, and a plan for collection of data on, the program, including, but not limited to:

(A) The number of timber harvest plans reviewed.

(B) Average time for plan review.

(C) Number of field inspections per inspector.

(D) Number of acres under active plans.

(E) Number of violations.

(F) Evaluating ecological performance.

(b) A report required to be submitted pursuant to subdivision (a) shall be submitted in compliance with Section 9795 of the Government Code.

4629.10. Submission of report including review of report on forest and Timberland regulation to Joint Legislative Budget Committee and to the relevant legislative policy committees.

(a) No later than March 1, 2014, as part of the 2014–15 budget process, the Secretary of the Natural Resources Agency, in conjunction with the Secretary for Environmental Protection, shall submit a report to the Joint Legislative Budget Committee and to the relevant legislative policy committees, including a review of the report required to be submitted to the Joint Legislative Budget Committee pursuant to Section 4629.9. This review shall include recommendations to the budget committees on the future funding of the program, the adequacy of the current regulatory programs, and suggestions for policy recommendations that will improve this chapter and its implementing regulations, and other aspects of the laws governing timber harvesting in the state.

(b) (1) A report required to be submitted pursuant to subdivision (a) shall be submitted in compliance with Section 9795 of the Government Code.

4629.11. Accounting of revenues on accrued basis; authorization to borrow against anticipated revenues; repayment of loan.

Z'BERG-NEJEDLY FOREST PRACTICE ACT

(a) Notwithstanding any other law, the revenues in any fiscal year may be accounted for on an accrued basis. The department may borrow against anticipated revenues to the fund to meet cashflow needs.

(b) Notwithstanding any other law, a loan obtained pursuant to subdivision (a) shall be interest free. The department shall repay the loan in a timely manner from reserves received into the fund.

4629.12. Loan from General Fund; repayment.

(a) The Director of Finance shall authorize a loan, from the General Fund to the fund, to implement the activities described in Section 4629.6.

(b) Any loan made pursuant to this section shall be repaid, with interest at the pooled money investment rate, from revenues from the assessment imposed pursuant to Section 4629.5.

4629.13. Use of moneys in fund for cashflow loans to General Fund; interest.

Notwithstanding any other law, the Controller may use the moneys in the fund for cashflow loans to the General Fund, as provided in Sections 16310 and 16381 of the Government Code. Any such loan shall be exempt from paragraph (2) of subdivision (b) of Section 16310 of the Government Code. Interest shall be paid on all moneys loaned to the General Fund and shall be computed at a rate determined by the Pooled Money Investment Board to be the current earning rate of the fund from which the money is loaned. This section does not authorize any transfer that would interfere with the carrying out of the object for which these funds were created.

PROTECTION OF FOREST, RANGE AND FORAGE LANDS; PROHIBITED ACTIVITIES

PERTINENT EXCERPTS FROM PROTECTION OF FOREST, RANGE AND FORAGE LANDS; PROHIBITED ACTIVITIES.

Public Resources Code, Division 4, Chapter 6.

4427. Operation of fire causing equipment.

During any time of the year when burning permits are required in an area pursuant to this article, no person shall use or operate any motor, engine, boiler, stationary equipment, welding equipment, cutting torches, tarpots, or grinding devices from which a spark, fire, or flame may originate, which is located on or near any forest-covered land, brush-covered land, or grass-covered land, without doing both of the following:

(a) First clearing away all flammable material, including snags, from the area around such operation for a distance of 10 feet.

(b) Maintain one serviceable round point shovel with an overall length of not less than forty-six (46) inches and one backpack pump water-type fire extinguisher fully equipped and ready for use at the immediate area during the operation.

This section does not apply to portable powersaws and other portable tools powered by a gasoline-fueled internal combustion engine.

4428. Use of hydrocarbon powered engines near forest, brush or grass covered lands without maintaining firefighting tools.

No person, except any member of an emergency crew or except the driver or owner of any service vehicle owned or operated by or for, or operated under contract with, a publicly or privately owned utility, which is used in the construction, operation, removal, or repair of the property or facilities of such utility when engaged in emergency operations, shall use or operate any vehicle, machine, tool or equipment powered by an internal combustion engine operated on hydrocarbon fuels, in any industrial operation located on or near any forest, brush, or grass-covered land between April 1 and December 1 of any year, or at any other time when ground litter and vegetation will sustain combustion permitting the spread of fire, without providing and maintaining, for firefighting purposes only, suitable and serviceable tools in the amounts, manner and location prescribed in this section.

(a) On any such operation a sealed box of tools shall be located, within the operating area, at a point accessible in the event of fire. This fire toolbox shall contain: one backpack pump-type fire extinguisher filled with water, two axes, two McLeod fire tools, and a sufficient number of shovels so that each employee at the operation can be equipped to fight fire.

(b) One or more serviceable chainsaws of three and one-half or more horsepower with a cutting bar 20 inches in length or longer shall be immediately available within the operating area, or, in the alternative, a full set of timber-felling tools shall be located in the fire toolbox, including one crosscut falling saw six feet in length, one double-bit ax with a 36-inch handle, one sledge hammer or maul with a head weight of six, or more, pounds and handle length of 32 inches, or more, and not less than two falling wedges.

(c) Each rail speeder and passenger vehicle, used on such operation shall be equipped with one shovel and one ax, and any other vehicle used on the operation shall be equipped with one shovel. Each tractor used in such operation shall be equipped with one shovel.

(d) As used in this section:

(1) "Vehicle" means a device by which any person or property may be propelled, moved, or drawn over any land surface, excepting a device moved by human power or used exclusively upon stationary rails or tracks.

(2) "Passenger vehicle" means a vehicle which is self-propelled and which is designed for carrying not more than 10 persons including the driver, and which is used or maintained for the transportation of persons, but does not include any motor truck or truck tractor.

PROTECTION OF FOREST, RANGE AND FORAGE LANDS; PROHIBITED ACTIVITIES

4429. Camps or local headquarters, firefighting equipment.

During any time of the year when burning permits are required in an area pursuant to this article, at any camp maintained in such area for the residence of employees, or at any local headquarters in such area of any industrial, agricultural, or other operations on or near any forest-covered land or brush-covered land, there shall be provided and maintained at all times, in a specific location, for firefighting purposes only, a sufficient supply of serviceable tools to equip 50 percent of the able-bodied, personnel, resident of such camp, or working out of such headquarters, for fighting fires. Among these tools shall be included shovels, axes, saws, backpack pumps, and scraping tools. With such tools there shall also be one serviceable headlight adaptable for attachment to at least one-half of the tractor-bulldozers used on the operation, and a sufficient number of canteens and flashlights to equip a third of the able-bodied personnel.

4431. Gasoline powered saws, etc.; firefighting equipment.

During any time of the year when burning permits are required in an area pursuant to this article, no person shall use or operate or cause to be operated in the area any portable saw, auger, drill, tamper, or other portable tool powered by a gasoline-fueled internal combustion engine on or near any forest-covered land, brush-covered land, or grass-covered land, within 25 feet of any flammable material, without providing and maintaining at the immediate locations of use or operation of the saw or tool, for firefighting purposes one serviceable round point shovel, with an overall length of not less than 46 inches, or one serviceable fire extinguisher. The Director of Forestry and Fire Protection shall by administrative regulation specify the type and size of fire extinguisher necessary to provide at least minimum assurance of controlling fire caused by use of portable power tools under various climatic and fuel conditions.

The required fire tools shall at no time be farther from the point of operation of the power saw or tool than 25 feet with unrestricted access for the operator from the point of operation.

4442. Spark arresters or fire prevention measures; requirement; exemptions.

(a) Except as otherwise provided in this section, no person shall use, operate, or allow to be used or operated, any internal combustion engine which uses hydrocarbon fuels on any forest-covered land, brush-covered land, or grass-covered land unless the engine is equipped with a spark arrester, as defined in subdivision (c), maintained in effective working order or the engine is constructed, equipped, and maintained for the prevention of fire pursuant to Section 4443.

(b) Spark arresters affixed to the exhaust system of engines or vehicles subject to this section shall not be placed or mounted in such a manner as to allow flames or heat from the exhaust system to ignite any flammable material.

(c) A spark arrester is a device constructed of nonflammable materials specifically for the purpose of removing and retaining carbon and other flammable particles over 0.0232 of an inch in size from the exhaust flow of an internal combustion engine that uses hydrocarbon fuels or which is qualified and rated by the United States Forest Service.

(d) Engines used to provide motive power for trucks, truck tractors, buses, and passenger vehicles, except motorcycles, are not subject to this section if the exhaust system is equipped with a muffler as defined in the Vehicle Code.

(e) Turbocharged engines are not subject to this section if all exhausted gases pass through the rotating turbine wheel, there is no exhaust bypass to the atmosphere, and the turbocharger is in effective mechanical condition.

(f) Motor vehicles when being operated in an organized racing or competitive event upon a closed course are not subject to this section if the event is conducted under the auspices of a recognized sanctioning body and by permit issued by the fire protection authority having jurisdiction.

WILD AND SCENIC RIVERS ACT

PERTINENT EXCERPTS FROM THE WILD AND SCENIC RIVERS ACT.

Public Resources Code, Division 5, Chapter 1.4.

5093.50. Legislative declaration.

It is the policy of the State of California that certain rivers which possess extraordinary scenic, recreational, fishery, or wildlife values shall be preserved in their free-flowing state, together with their immediate environments, for the benefit and enjoyment of the people of the state. The Legislature declares that such use of these rivers is the highest and most beneficial use and is a reasonable and beneficial use of water within the meaning of Section 2 of Article X of the California Constitution. It is the purpose of this chapter to create a California Wild and Scenic Rivers System to be administered in accordance with the provisions of this chapter.

5093.52. Definitions.

As used in this chapter:

(a) "Secretary" means the Secretary of the Resources Agency.

(b) "Resources Agency" means the Secretary of the Resources Agency and any constituent units of the Resources Agency that the secretary determines to be necessary to accomplish the purposes of this chapter.

(c) "River" means the water, bed, and shoreline of rivers, streams, channels, lakes, bays, estuaries, marshes, wetlands, and lagoons, up to the first line of permanently established Riparian vegetation.

(d) "Free-flowing" means existing or flowing without artificial impoundment, diversion, or other modification of the river. The presence of low dams, diversion works, and other minor structures does not automatically bar a river's inclusion within the system. However, this subdivision does not authorize or encourage future construction of those structures on any component of the system.

(e) "System" means the California Wild and Scenic Rivers System.

(f) "Land use regulation" means the regulation by any state or local governmental entity, agency, or official of any activities that take place other than directly on the waters of the segments of the rivers designated in Section 5093.54.

(g) "Director" means the Director of Fish and Game.

(h) "Immediate environments" means the land immediately adjacent to the segments of the rivers designated in Section 5093.54.

(i) "Special Treatment Areas" means, for purposes of this chapter, those areas defined as Special Treatment Areas in Section 895.1 of Title 14 of the California Code of Regulations, as in effect on January 1, 2004, as that definition applies to wild and scenic river segments designated from time to time in Section 5093.54, and also includes areas within 200 feet of the Watercourse Transition Line of a state-designated recreational river segment designated in Section 5093.54 that may be at risk during Timber Operations.

(j) "Board" means the State Board of Forestry and Fire Protection.

5093.53. Classification of rivers.

Those rivers or segments of rivers included in the system shall be classified as one of the following:

(a) Wild rivers, which are those rivers or segments of rivers that are free of impoundments and generally inaccessible except by trail, with watersheds or shorelines essentially primitive and waters unpolluted.

(b) Scenic rivers, which are those rivers or segments of rivers that are free of impoundments, with shorelines or watersheds still largely primitive and shorelines largely undeveloped, but accessible in places by roads.

(c) Recreational rivers, which are those rivers or segments of rivers that are readily accessible by road or railroad, that may have some development along their shorelines, and that may have undergone some impoundment or diversion in the past.

WILD AND SCENIC RIVERS ACT

5093.54. Components of systems.

The following rivers and segments thereof are designated as components of the system:

(a) Klamath River. The main stem from 100 yards below Iron Gate Dam to the Pacific Ocean; the Scott River from the mouth of Shackelford Creek west of Fort Jones to the river mouth near Hamburg; the Salmon River from Cecilville Bridge to the river mouth near Somes bar; the North Fork of the Salmon River from the intersection of the river with the south boundary of the Marble Mountain Wilderness area to the river mouth; Wooley Creek from the western boundary of the Marble Mountain Wilderness area to its confluence with the Salmon River.

(b) Trinity River. The main stem from 100 yards below Lewiston Dam to the river mouth at Weitchpec; the North Fork of the Trinity from the intersection of the river with the southern boundary of the Salmon-Trinity Primitive Area downstream to the river mouth at Helena; New River from the intersection of the river with the southern boundary of the Salmon-Trinity Primitive Area downstream to the river mouth near Burnt Ranch; South Fork of the Trinity from the junction of the river with State Highway Route 36 to the river mouth near Salyer.

(c) Smith River. The main stem from the confluence of the Middle and South Forks to its mouth at the Pacific Ocean; the Middle Fork from its source about three miles south of Sanger Lake as depicted on 1956 USGS 15' "Preston Peak" topographic map to the middle of Section 7 T17N R5E; the Middle Fork from the middle of Section 7 T17N R5E to the middle of Section 6 T17N R5E; the Middle Fork from the middle of Section 6 T17N R5E to one-half mile upstream from the confluence with Knopki Creek; the Middle Fork from one-half mile upstream from the confluence with Knopki Creek to the confluence with the South Fork; Myrtle Creek from its source in Section 9 T17N R1E as depicted on 1952 USGS 15' "Crescent City" topographic map to the middle of Section 28 T17N R1E; Myrtle Creek, from the middle of Section 28 T17N R1E to the confluence with the Middle Fork; Shelly Creek from its source in Section 1 T18N R3E as depicted on 1951 USGS 15' "Gasquet" topographic map to the confluence with Patrick Creek; Kelly Creek from its source in Section 32 T17N R3E as depicted on 1951 USGS 15' "Gasquet" topographic map to the confluence with the Middle Fork; Packsaddle Creek from its source about 0.8 miles southwest of Broken Rib Mountain as depicted on 1956 USGS 15' "Preston Peak" topographic map to the eastern boundary of Section 3 T17N R1E; Packsaddle Creek from the eastern boundary of Section 3 T17N R4E to the northern boundary of Section 3 T17N R4E; Packsaddle Creek from the northern boundary of Section 3 T17N R4E to the confluence with the Middle Fork; East Fork Patrick Creek from its source in Section 10 T18N R3E as depicted on 1951 USGS 15' "Gasquet" topographic map to the confluence with West Fork Patrick Creek; West Fork Patrick Creek from its source in Section 18 T18N R3E as depicted on 1951 15' "Gasquet" topographic map to the confluence with East Fork Patrick Creek; Griffin Creek from its source about 0.2 miles southwest of Hazel View Summit as depicted on 1956 USGS 15' "Preston Peak" topographic map to the confluence with the Middle Fork; Knopki Creek from its source about 0.4 miles west of Sanger Peak as depicted on 1956 USGS 15' "Preston Peak" topographic map to the confluence with Middle Fork; Monkey Creek from its source in the northeast quadrant of Section 12 T18N R3E as depicted on 1951 USGS 15' "Gasquet" topographic map to the northern boundary of Section 26 T18N R3E; Monkey Creek from the northern boundary of Section 26 T18N R3E to the confluence with the Middle Fork; Patrick Creek from the junction of the East and West Forks of Patrick Creek to the confluence with Middle Fork; the North fork from the California-Oregon boundary to the confluence with an unnamed tributary in the northern quarter Section 5 T18N R2E as depicted on 1951 USGS 15' "Gasquet" topographic map; the North Fork from the confluence with an unnamed tributary in northern quarter of Section 5 T18N R2E to the southernmost intersection of eastern boundary Section 5 T18N R2E as depicted on 1951 USGS 15' "Gasquet" topographic map; the North Fork from the southernmost intersection of eastern boundary Section 5 T18N R2E as depicted on 1951 USGS 15' "Gasquet" topographic map to the confluence with Stony Creek; the North Fork from the confluence with Stony Creek to the confluence with Middle Fork; Diamond Creek from the California-Oregon state boundary to the confluence with High Plateau Creek; Diamond Creek from the confluence with High Plateau Creek to the confluence with the North Fork; Bear Creek from its source in Section 24 T18N R2E as depicted on 1951 USGS 15' "Gasquet" topographic map to the confluence with Diamond Creek; Still Creek from its source in

WILD AND SCENIC RIVERS ACT

Section 11 T18N R1E as depicted on 1952 USGS 15' "Crescent City" topographic map to the confluence with the North Fork Smith River; North Fork Diamond Creek from the California-Oregon state boundary to the confluence with Diamond Creek; High Plateau Creek from its source in Section 26 T18N R2E as depicted on 1951 USGS 15' "Gasquet" topographic map to northern boundary Section 23 T18N R2E; High Plateau Creek from the northern boundary Section 23 T18N R2E to the confluence with Diamond Creek; the Siskiyou Fork from its source about 0.7 miles southeast of Broken Rib Mountain as depicted on 1956 USGS 15' "Preston Peak" topographic map to the confluence with the South Siskiyou Fork; the Siskiyou Fork from its confluence with the South Siskiyou Fork to the confluence with the Middle Fork; the South Siskiyou Fork from its source about 0.6 miles southwest of Buck Lake as depicted on 1956 USGS 15' "Preston Peak" topographic map to the confluence with the Siskiyou Fork; the South Fork from its source about 0.5 miles southwest of Bear Mountain as depicted on 1956 USGS 15' "Preston Peak" topographic map to Blackhawk Bar; the South Fork from Black Hawk Bar to the confluence with the Middle Fork; Williams Creek from its source in Section 31 T14N R4E as depicted on 1952 USGS 15' "Ship Mountain" topographic map to the confluence with Eight Mile Creek; Eight Mile Creek from its source in Section 29 T14N R4E as depicted on 1955 USGS 15' "Dillon Mountain" topographic map to the confluence with the South Fork; the Prescott Fork from its source about 0.5 miles southeast of Island Lake as depicted on 1955 USGS 15' "Dillon Mountain" topographic map to the confluence with the South Fork; Quartz Creek from its source in Section 31 T16N R4E as depicted on 1952 USGS 15' "Ship Mountain" topographic map to the confluence with the South Fork; Jones Creek from its source in Section 36 T16N R3E as depicted on 1952 USGS 15' "Ship Mountain" topographic map to the middle of Section 5 T15N R3E; Jones Creek from the middle of Section 5 T15N R3E to the confluence with the South Fork; Hurdygurdy Creek from its source about 0.4 miles southwest of Bear Basin Butte as depicted on 1956 USGS 15' "Preston Peak" topographic map to the confluence with the South Fork; Gordon Creek from its source in Section 18 T16N R3E as depicted on 1951 USGS 15' "Gasquet" topographic map to the confluence with the South Fork; Coon Creek from the junction of the two-source tributaries in the southwest quadrant of Section 31 T17N R3E as depicted on 1951 USGS 15' "Gasquet" topographic map to the western boundary Section 14 T16N R2E Coon Creek from the western boundary Section 14 T16N R2E to the confluence with the South Fork; Craigs Creek from its source in Section 36 T17N R2E as depicted on 1951 USGS 15' "Gasquet" topographic map to the confluence with the South Fork; Buck Creek from its source at Cedar Camp Spring as depicted on 1952 USGS 15' "Ship Mountain" topographic map to the confluence with the South Fork; Muzzleloader Creek from its source in Section 2 T15N R3E as depicted on 1952 USGS 15' "Ship Mountain" topographic map to the confluence with Jones Creek; Canthook Creek from its source in Section 2 T15N R2E as depicted on 1952 USGS 15' "Ship Mountain" topographic map to the confluence with Jones Creek; Canthook Creek from its source in Section 2 T15N R2E as depicted on 1952 USGS 15' "Ship Mountain" topographic map to the confluence with South Fork.

(d) Eel River. The main stem from 100 yards below Van Arsdale Dam to the Pacific Ocean; the South Fork of the Eel from the mouth of Section Four Creek near Branscomb to the river mouth below Weott; Middle Fork of the Eel from the intersection of the river with the southern boundary of the Middle Eel-Yolla Bolly Wilderness Area to the river mouth at Dos Rios; North Fork of the Eel from the Old Gilman Ranch downstream to the river mouth near Ramsey; Van Duzen River from Dinsmores Bridge downstream to the river mouth near Fortuna.

(e) American River. The North Fork from its source to the Iowa Hill Bridge; the Lower American from Nimbus Dam to its junction with the Sacramento River.

(f) **(1)** West Walker River. The main stem from its source to the confluence with Rock Creek near the town of Walker; Leavitt Creek from Leavitt Falls to the confluence with the main stem of the West Walker River.

(2) Carson River. The East Fork from the Hangman's Bridge crossing of State Highway Route 89 to the California Nevada border.

(3) The Legislature finds and declares that, because the East Fork Carson River and West Walker River are interstate streams, and a source of agricultural water and domestic water for communities within the Counties of Alpine and Mono where they originate, it is necessary that the

WILD AND SCENIC RIVERS ACT

following special provisions apply:

(A) Nothing in this subdivision shall be construed to prohibit the replacement of diversions or changes in the purpose of use, place of use, or point of diversion under existing water rights, except that (i) no replacement or change shall operate to increase the adverse effect, if any, of the preexisting diversion facility or place or purpose of use, upon the free-flowing condition and natural character of the stream, and (ii) after January 1, 1990, no new diversion shall be constructed unless and until the secretary determines that the facility is needed to supply domestic water to the residents of any county through which the river or segment flows and that the facility will not adversely affect the free-flowing condition and natural character of the stream.

(B) Nothing in this chapter shall be construed as quantifying or otherwise affecting any equitable apportionment, or as establishing any upper limit, between the State of California and the State of Nevada of the waters of these streams.

(g) **(1)** The South Yuba River: From Lang Crossing to its confluence with Kentucky Creek below Bridgeport.

(2) Nothing in this subdivision shall prejudice, alter, delay, interfere with, or affect in any way, the existing rights of the Placer County Water Agency, the implementation of those rights; any historic water use practices; the replacement, maintenance, repair, operation, or future expansion of existing diversions, storage, powerhouses, or conveyance facilities or other works by the Placer County Water Agency; or changes in the purpose of use, places of use, points of diversion, or ownership of those existing water rights; nor shall anything in this subdivision preclude the issuance of any governmental authorization needed for utilization of those rights, except that no changes shall operate to increase the adverse effect, if any, of the preexisting facilities or places, or the purposes of use upon the free-flowing and natural character of the river segment designated in this subdivision.

(h) Albion River. The Albion River from one-fourth mile upstream of its confluence with Deadman Gulch downstream to its mouth at the Pacific Ocean.

(i) Gualala River. The main stem Gualala River from the confluence of the North and South Forks to the Pacific Ocean.

(j) **(1)** Cache Creek from one-fourth mile below Cache Creek Dam to Camp Haswell.

(2) North Fork Cache Creek from the Highway 20 bridge to the confluence with the main stem.

(3) The designation of Cache Creek under paragraphs (1) and (2) shall not prejudice, alter, delay, interfere with, or affect in any way, the existing water rights of the Yolo County Flood Control and Water Conservation District, or public water agencies within the Cache Creek watershed lying in the County of Lake, including the range of operations permitted under these existing water rights; any historic water use practices within existing water rights; or the replacement, maintenance, repair, or future expansion within existing water rights of existing diversion, storage, powerhouse, or conveyance facilities or other works by the Yolo County Flood Control and Water Conservation District or public water agencies within the Cache Creek watershed lying in the County of Lake.

(4) The designation of Cache Creek under paragraphs (1) and (2) shall not prejudice, alter, delay, interfere with, or affect any changes to the existing water rights of the Yolo County Flood Control and Water Conservation District, including changes to the purpose of use, place of use, points of diversion, quantity of water diverted, or ownership, or applications by the district for new water rights; provided, that the changes or applications do not involve the construction of a dam, reservoir, diversion, or other water impoundment facility within the segments of Cache Creek designated in paragraphs (1) and (2). Any such change or application shall be subject to all applicable constitutional, statutory, and judicial requirements, including the public trust doctrine.

(5) As the waters of the Cache Creek watershed are the sole source of supply within that watershed for the County of Lake, the designation of Cache Creek under paragraphs (1) and (2) shall not prejudice, alter, delay, interfere with, or affect any changes to the existing water rights of the public water agencies within the Cache Creek watershed lying in the County of Lake, including changes to the purpose of use, place of use, points of diversion, quantity of water diverted, or ownership, or applications by these agencies for new water rights; provided, that the changes or applications do not involve the construction of a dam, reservoir, diversion, or other water

WILD AND SCENIC RIVERS ACT

impoundment facility within the segments of Cache Creek designated in paragraphs (1) and (2). Any such change or application shall be subject to all applicable constitutional, statutory, and judicial requirements, including the public trust doctrine.

(6) (A) The designation of Cache Creek under paragraphs (1) and (2) shall not impair or affect in any way activities to manage or remove invasive or nonnative plants and animal species.

(B) The designation of Cache Creek under paragraphs (1) and (2) shall not impair or affect in any way activities to remediate mercury pollution; provided, that this activity does not involve the construction of a dam, reservoir, diversion, or other water impoundment facility within the segments of Cache Creek designated in paragraphs (1) and (2).

(7) (A) Neither the Governor nor an employee of a state agency or department shall apply to a secretary, department, agency, or other entity of the federal government for the designation of any portion of Cache Creek as a component of the national wild and scenic rivers system under the federal Wild and Scenic Rivers Act (16 U.S.C. Sec. 1271 et seq.).

(B) Neither the Governor nor an employee of a state agency or department shall expend funds preparing, filing, or otherwise submitting an application to a secretary, department, or other entity of the federal government for the designation of any portion of Cache Creek as a component of the national wild and scenic rivers system under the federal Wild and Scenic Rivers Act (16 U.S.C. Sec. 1271 et seq.).

(8) To the extent that this subdivision conflicts with other provisions of this chapter, this subdivision shall control.

(k) (1) Mokelumne River. The following segments are designated:

(A) Segment A1: North Fork Mokelumne River from 0.50 miles downstream of the Salt Springs Dam to Bear River confluence.

(B) Segment A2: North Fork Mokelumne River from the Bear River confluence to 0.50 miles upstream of the Tiger Creek Powerhouse.

(C) Segment B: North Fork Mokelumne River from 1,000 feet downstream of the Tiger Creek Afterbay Dam to State Highway Route 26 (SR-26).

(D) Segment C1: North Fork Mokelumne River from 400 feet downstream of the small reregulating dam at the outlet of the West Point Powerhouse to the southern boundary of Section 12, T6N R12E.

(E) Segment C2: Section 12 boundary to confluence of the North and Middle Forks Mokelumne River.

(F) Segment D: Mokelumne River from the confluence of the North and Middle Forks to 300 feet upstream of the Electra Powerhouse.

(G) Segment E: Mokelumne River from 300 feet downstream of the small reregulating dam downstream of the Electra Powerhouse to the Pardee Reservoir flood surcharge pool at 580 feet elevation above mean sea level.

(2) The designation of the Mokelumne River segments under paragraph (1) is subject to all of the following special provisions:

(A) The designation of the identified segments of the Mokelumne River into the system shall not prejudice, alter, delay, interfere with, or affect in any way, the existing water rights of the Pacific Gas and Electric Company or public water agencies in the Counties of Alpine, Amador, and Calaveras, including the Amador Water Agency's pending water right application 5647X03; the range of operations permitted under these existing water rights; any historic consumptive water use practices within existing water rights; full utilization of existing water rights, including changes in the purposes of use, places of use, points of diversion, quantities of water diverted or ownership; or the replacement, maintenance, repair, rehabilitation or alteration, or operation of facilities with no or negligible expansion of capacity within existing water rights of existing diversion, storage, powerhouse, or conveyance facilities or other works by the Pacific Gas and Electric Company or public water agencies in the Counties of Alpine, Amador, and Calaveras. Nothing in this subdivision shall preclude the issuance of any governmental authorization or financial assistance needed for full utilization of those rights. No such changes shall cause an

WILD AND SCENIC RIVERS ACT

adverse effect upon the free-flowing condition, natural character, immediate environments, or extraordinary scenic or recreational values of the river segments designated herein, provided that the existing water rights and facilities may be utilized to their fullest extent in accordance with applicable law. For the purposes of this designation, an adverse effect will be considered to be significant impairment to flows that would otherwise exist within designated segments.

(B) The designation of the identified segments of the Mokelumne River into the system shall not prejudice, alter, delay, interfere with, or affect any applications for new water rights by the Pacific Gas and Electric Company, or any applications for new water rights or unappropriated water that may be available under State Filings 5647 and 5648 by public water agencies in the Counties of Alpine, Amador, and Calaveras, provided that the applications do not involve the construction of a dam, reservoir, other water impoundment facility within the designated segments, impound water on a designated segment, or diversion on a designated segment in a manner inconsistent with this chapter, nor cause an adverse effect upon the free-flowing condition, natural character, immediate environments, or extraordinary scenic or recreational values, or both, of the river segments designated herein. Any change, application, or future new projects or existing projects with significant expansion in capacity under this subdivision shall be subject to a determination that any such future changes will not cause an adverse effect upon the free-flowing condition, natural character, immediate environments, or extraordinary scenic or recreational values of the river segments designated herein. Nothing in this subdivision shall preclude the issuance of any governmental authorization or financial assistance needed for the feasibility study and review pursuant to the California Environmental Quality Act (Division 13 (commencing with Section 21000)) of any such change, application, or projects. For the purposes of this designation, an adverse effect will be considered to be significant impairment to flows that would otherwise exist within designated segments.

(C) The designation of the identified segments of the Mokelumne River into the system shall not prejudice, alter, affect in any way, or interfere with the maintenance, repair, or operation by the Pacific Gas and Electric Company of the Mokelumne River Project (FERC No. 137) currently under the 2001 Federal Energy Regulatory Commission license for the project, the incorporated settlement agreement, any license amendments made with the agreement of the parties to the incorporated settlement agreement, and any adjustment of flows permitted to occur pursuant to the license for enhancement of ecological and recreational resources. The designation of the identified segments of the Mokelumne River into the state wild and scenic rivers system shall not prejudice, alter, affect in any way or interfere with the maintenance, repair, or recreational opportunities of the Roaring Camp Mining Company and its associated structures, facilities, and land.

(D) Neither the Governor nor an employee of a state agency or department shall expend funds preparing, filing, applying, nominating, or otherwise submitting an application to a secretary, department, agency, or other entity of the federal government to include any segment designated herein into the National Wild and Scenic Rivers System under the National Wild and Scenic Rivers Act (16 U.S.C. Sec. 1271(2)(a)(ii)).

(E) To the extent that these special provisions conflict with other provisions of this chapter, this subdivision shall control.

(I) Other rivers which qualify for inclusion in the system may be recommended to the Legislature by the secretary.

5093.541. Tributaries of Smith River.

(a) Notwithstanding the fact that the tributaries of the Smith River specified in this subdivision are not included in the system, no dam, reservoir, diversion, or other water impoundment facility shall be constructed on any of the following tributaries of the Smith River:

- (1)** Dominie Creek.
- (2)** Rowdy Creek.

WILD AND SCENIC RIVERS ACT

- (3) South Fork Rowdy Creek.
- (4) Savoy Creek.
- (5) Little Mill Creek.
- (6) Bummer Lake Creek.
- (7) East Fork Mill Creek.
- (8) West Branch Mill Creek.
- (9) Rock Creek.
- (10) Goose Creek.
- (11) East Fork Goose Creek.
- (12) Mill Creek.

(b) All state agencies exercising powers under any other provision of law with respect to the protection and restoration of fishery resources shall continue to exercise those powers in a manner to protect and restore fishery resources in the tributaries specified in subdivision (a). In carrying out the provisions of this subdivision, any exercise of powers shall be consistent with the provisions of Section 5093.58.

5093.542. McCloud River; legislative findings and declarations.

The Legislature finds and declares that the McCloud River possesses extraordinary resources in that it supports one of the finest wild trout fisheries in the state. Portions of the river have been appropriately designated by the Fish and Game Commission, pursuant to Chapter 7.2 (commencing with Section 1725) of Division 2 of the Fish and Game Code, as wild trout waters, with restrictions on the taking, or method of taking, of fish. The Legislature has determined, based upon a review of comprehensive technical data evaluating resources and potential beneficial uses, that potential beneficial uses must be balanced, in order to achieve protection of the unique fishery resources of the McCloud River, as follows:

(a) The continued management of river resources in their existing natural condition represents the best way to protect the unique fishery of the McCloud River. The Legislature further finds and declares that maintaining the McCloud River in its free-flowing condition to protect its fishery is the highest and most beneficial use of the waters of the McCloud River within the segments designated in subdivision (b), and is a reasonable use of water within the meaning of Section 2 of Article X of the California Constitution.

(b) No dam, reservoir, diversion, or other water impoundment facility shall be constructed on the McCloud River from Algoma to the confluence with Huckleberry Creek, and 0.25 mile downstream from the McCloud Dam to the McCloud River Bridge; nor shall any such facility be constructed on Squaw Valley Creek from the confluence with Cabin Creek to the confluence with the McCloud River.

(c) Except for participation by the Department of Water Resources in studies involving the technical and economic feasibility of enlargement of Shasta Dam, no department or agency of the state shall assist or cooperate with, whether by loan, grant, license, or otherwise, any agency of the federal, state, or local government in the planning or construction of any dam, reservoir, diversion, or other water impoundment facility that could have an adverse effect on the free-flowing condition of the McCloud River, or on its wild trout fishery.

(d) All state agencies exercising powers under any other provision of law with respect to the protection and restoration of fishery resources shall continue to exercise those powers in a manner to protect and enhance the fishery of those segments designated in subdivision (b). In carrying out this subdivision, any exercise of powers shall be consistent with Section 5093.58.

(e) Nothing in this section shall prejudice, alter, affect in any way, or interfere with the construction, maintenance, repair, or operation by the Pacific Gas and Electric Company of the existing McCloud-Pit development (FERC 2106) under its license, or prevent Pacific Gas and Electric from constructing a hydroelectric generating facility by retrofitting the existing McCloud Dam if the operation of the facility does not alter the existing flow regime below the dam.

WILD AND SCENIC RIVERS ACT

5093.545. Revision and adoption of classification of rivers.

The classifications heretofore established by the secretary for the rivers or segments of rivers included in the system are revised and adopted as follows:

Rivers	Classification
<p>(a) Klamath River: The Klamath River from the FERC Project 2082 downstream boundary in Section 17 T47N R5W as shown on Exhibit K-7 sheet 1 dated May 25, 1962, to the river mouth at the Pacific Ocean</p>	Recreational
<p>(b) Scott River: (1) The Scott River from Shackelford Creek to McCarthy Creek (2) The Scott River from McCarthy Creek to Scott Bar (3) The Scott River from Scott Bar to the confluence with the Klamath River</p>	Recreational Scenic Recreational
<p>(c) Salmon River: (1) The Salmon River from the Forks of Salmon to the Lewis Creek confluence (2) The Salmon River from the Lewis Creek confluence to the Wooley Creek confluence (3) The Salmon River from the Wooley Creek confluence to the confluence with the Klamath River (4) The South Fork of the Salmon River from Cecilville to St. Claire Creek confluence (5) The South Fork from St. Claire Creek confluence to the Matthews Creek confluence (6) The South Fork from Matthews Creek confluence to the Forks of Salmon (7) The North Fork of the Salmon River from Marble Mountain Wilderness boundary to Mule Bridge Campground in Section 35 T12N R11W and Section 12 T11N R11W (8) The North Fork from Mule Bridge Campground to the Forks of Salmon (9) Wooley Creek from the Marble Mountain Wilderness Area boundary to 1/2 mile upstream of the confluence with Salmon River (10) Wooley Creek downstream 1/2 mile above the confluence with the Salmon River</p>	Recreational Scenic Recreational Recreational Scenic Recreational Wild Recreational Wild Recreational
<p>(d) Trinity River: (1) The Trinity River from 100 yards below Lewiston Dam to Cedar Flat Creek confluence (2) The Trinity River from Cedar Flat Creek confluence to Gray Falls (3) The Trinity River from Gray Falls to the west boundary of Section 2 T8N R4E (4) The Trinity River from the west boundary of Section 2 T8N R4E to the confluence with the Klamath River at Weitchpec (5) The North Fork of the Trinity River from the Trinity Alps Primitive Area boundary to north boundary Section 20 T34N R11W (6) The North Fork from the north boundary Section 20 T34N R11W to mouth (7) The South Fork Trinity River from Forest Glen to Hidden Valley Ranch (8) The South Fork from Hidden Valley Ranch to the Naufus Creek confluence in Section 8 T1N R7E (9) The South Fork from the Naufus Creek confluence in Section 8 T1N R7E to Johnson Creek confluence near the boundary of Sections 13 and 14 T2N R6E (10) The South Fork from Johnson Creek confluence near the boundary of Sections 13 and 14 T2N R6E to the boundary of Sections 25 and 36 T2N R6E (11) The South Fork from the boundary of Sections 25 and 36 T2N R6E to the footbridge near the mouth of Underwood Creek in Section 17 T4N R6E</p>	Recreational Scenic Recreational Scenic Wild Recreational Wild Scenic Wild Scenic Recreational

WILD AND SCENIC RIVERS ACT

Rivers	Classification
Humboldt Base and Meridian	
(12) The South Fork from the footbridge near the mouth of Underwood Creek in Section 17 T4N R6E to Todd Ranch in Section 18 T5N R5E	Wild
(13) The South Fork from Todd Ranch in Section 18 T5N R5E to the confluence with Main Trinity	Scenic
(14) New River from the Salmon Trinity Primitive Area boundary to the junction with the East Fork New River in Section 23 T7N R7E	Wild
(15) New River from the junction with the East Fork New River in Section 23 T7N R7E to 100 yards below Panther Creek Campground in Section 18 T6N R7E	Recreational
(16) New River from 100 yards below Panther Creek Camp-ground in Section 18 T6N R7E to Dyer Creek confluence in Section 25 T26N R6E	Scenic
(17) New River from Dyer Creek confluence in Section 25 T26N R6E to the confluence with Trinity River	Wild
(e) Smith River:	
(1) Smith River from the confluence of the Middle and South Forks to its mouth at the Pacific Ocean	Recreational
(2) Middle Fork Smith River from its source about 3 miles south of Sanger Lake as depicted on 1956 USGS 15' "Preston Peak" topographic map to the middle of Section 7 T17N R5E	Wild
(3) Middle Fork Smith River from the middle of Section 7 T17N R5E to the middle of Section 6 T17N R5E	Scenic
(4) Middle Fork Smith River from middle of Section 6 T17N R5E to one-half mile upstream from the confluence with Knopki Creek	Wild
(5) Middle Fork Smith River from one-half mile upstream from the confluence with Knopki Creek to the confluence with South Fork Smith River	Recreational
(6) Myrtle Creek from its source in Section 9 T17N R1E as depicted on 1952 USGS 15' "Crescent City" topographic map to the middle of Section 28 T17N R1E	Recreational
(7) Myrtle Creek from the middle of Section 28 T17N R1E to the confluence with the Middle Fork Smith River	Recreational
(8) Shelly Creek from its source in Section 1 T18N R3E as depicted on 1951 USGS 15' "Gasquet" topographic map to the confluence with Patrick Creek	Recreational
(9) Kelly Creek from its source in Section 32 T17N R3E as depicted on 1951 USGS 15' "Gasquet" topographic map to the confluence with the Middle Fork Smith River	Recreational
(10) Packsaddle Creek from its source about 0.8 miles southwest of Broken Rib Mountain as depicted on 1956 USGS 15' "Preston Peak" topographic map to the eastern boundary of Section 3 T17N R1E	Recreational
(11) Packsaddle Creek from the eastern boundary of Section 3 T17N R4E to the northern boundary of Section 3 T17N R4E	Recreational
(12) Packsaddle Creek from the northern boundary of Section 3 T17N R4E to the confluence with the Middle Fork of Smith River	Recreational
(13) East Fork Patrick Creek from its source in Section 10 T18N R3E as depicted on 1951 USGS 15' "Gasquet" topographic map to the confluence with the West Fork Patrick Creek	Recreational
(14) West Fork Patrick Creek from its source in Section 18 T18N R3E as depicted on 1951 USGS 15' "Gasquet" topographic map to the confluence with the East Fork Patrick Creek	Recreational
(15) Griffin Creek from its source about 0.2 miles southwest of Hazel View Summit as depicted on 1956 USGS 15' "Preston Peak" topographic map to the	Recreational

WILD AND SCENIC RIVERS ACT

Rivers	Classification
confluence with the Middle Fork Smith River	
(16) Knopki Creek from its source about 0.4 miles west of Sanger Peak as depicted on 1956 USGS 15' "Preston Peak" topographic map to the confluence with the Middle Fork Smith River	Recreational
(17) Monkey Creek from its source in the northeast quadrant of Section 12 T18N R3E as depicted on 1951 USGS 15' "Gasquet" topographic map to the northern boundary of Section 26 T18N R3E	Recreational
(18) Monkey Creek from the northern boundary of Section 26 T18N R3E to the confluence with the Middle Fork of Smith River	Recreational
(19) Patrick Creek from the junction of East and West Forks of Patrick Creek to the confluence with the Middle Fork Smith River	Recreational
(20) North Fork Smith River from the California-Oregon boundary to the confluence with an unnamed tributary in the northern quarter Section 5 T18N R2E as depicted on 1951 USGS 15' "Gasquet" topographic map	Wild
(21) North Fork Smith River from the confluence with an unnamed tributary in the northern quarter of Section 5 T18N R2E to the southern-most intersection of the eastern boundary of Section 5 T18N R2E as depicted on 1951 USGS 15' "Gasquet" topographic map	Scenic
(22) North Fork Smith River from the southernmost intersection of the eastern boundary Section 5 T18N R2E as depicted on 1951 USGS 15' "Gasquet" topographic map to the confluence with Stony Creek	Wild
(23) North Fork Smith River from the confluence with Stony Creek to the confluence with the Middle Fork of the Smith River	Recreational
(24) Diamond Creek from the California-Oregon state boundary to the confluence with High Plateau Creek	Recreational
(25) Diamond Creek from the confluence with High Plateau Creek to the confluence with the North Fork Smith River	Recreational
(26) Bear Creek from its source in Section 24 T18N R2E as depicted on 1951 USGS 15' "Gasquet" topographic map to the confluence with Diamond Creek	Recreational
(27) Still Creek from its source in Section 11 T18N R1E as depicted on 1952 USGS 15' "Crescent City" topographic map to the confluence with the North Fork Smith River	Recreational
(28) North Fork Diamond Creek from the California-Oregon state boundary to the confluence with Diamond Creek	Recreational
(29) High Plateau Creek from its source in Section 26 T18N R2E as depicted on 1951 USGS 15' "Gasquet" topographic map to the northern boundary Section 23 T18N R2E	Recreational
(30) High Plateau Creek from the northern boundary Section 23 T18N R2E to the confluence with Diamond Creek	Recreational
(31) Siskiyou Fork of Smith River from its source about 0.7 miles southeast of Broken Rib Mountain as depicted on 1956 USGS 15' "Preston Peak" topographic map to the confluence with the South Siskiyou Fork of the Smith River	Wild
(32) Siskiyou Fork of the Smith River from the confluence with the South Siskiyou Fork of the Smith River to the confluence with the Middle Fork of the Smith River	Recreational
(33) South Siskiyou Fork of the Smith River from its source about 0.6 miles southwest of Buck Lake as depicted on 1956 USGS 15' "Preston Peak" topographic map to the confluence with the Siskiyou Fork of the Smith River	Wild
(34) South Fork Smith River from its source about 0.5 miles southwest of Bear Mountain as depicted on 1956 USGS 15' "Preston Peak" topographic map to Blackhawk Bar	Wild

WILD AND SCENIC RIVERS ACT

Rivers	Classification
(35) South Fork Smith River from Blackhawk Bar to the confluence with the Middle Fork Smith River	Recreational
(36) Williams Creek from its source in Section 31 T14N R4E as depicted on 1952 USGS 15' "Ship Mountain" topographic map to the confluence with Eight Mile Creek	Recreational
(37) Eight Mile Creek from its source in Section 29 T14N R4E as depicted on 1955 USGS 15' "Dillon Mtn." topographic map to the confluence with the South Fork Smith River	Recreational
(38) Prescott Fork of the Smith River from its source about 0.5 miles southeast of Island Lake as depicted on 1955 USGS 15' "Dillon Mtn." topographic map to the confluence with the South Fork Smith River	Recreational
(39) Quartz Creek from its source in Section 31 T16N R4E as depicted on 1952 USGS 15' "Ship Mountain" topographic map to the confluence with the South Fork Smith River	Recreational
(40) Jones Creek from its source in Section 36 T16N R3E as depicted on 1952 USGS 15' "Ship Mountain" topographic map to the middle of Section 5 T15N R3E	Recreational
(41) Jones Creek from the middle of Section 5 T15N R3E to the confluence with the South Fork of the Smith River	Recreational
(42) Hurdygurdy Creek from its source about 0.4 miles southwest of Bear Basin Butte as depicted on 1956 USGS 15' "Preston Peak" topographic map to the confluence with the South Fork Smith River	Recreational
(43) Gordon Creek from its source in Section 18 T16N R3E as depicted on 1951 USGS 15' "Gasquet" topographic map to the confluence with the South Fork Smith River	Recreational
(44) Coon Creek from the junction of the two source tributaries in the southwest quadrant of Section 31 T17N R3E as depicted on 1951 USGS 15' "Gasquet" topographic map to the western boundary of Section 14 T16N R2E	Recreational
(45) Coon Creek from the western boundary of Section 14 T16N R2E to the confluence with the South Fork Smith River	Recreational
(46) Craigs Creek from its source in Section 36 T17N R2E as depicted on 1951 USGS 15' "Gasquet" topographic map to the confluence with the South Fork Smith River	Recreational
(47) Buck Creek from its source at Cedar Camp Spring as depicted on 1952 USGS 15' "Ship Mountain" topographic map to the confluence with the South Fork Smith River	Recreational
(48) Muzzleloader Creek from its source in Section 2 T15N R3E as depicted on 1952 USGS 15' "Ship Mountain" topographic map to the confluence with Jones Creek	Recreational
(49) Canthook Creek from its source in Section 2 T15N R2E as depicted on 1952 USGS 15' "Ship Mountain" topographic map to the confluence with the South Fork Smith River	Recreational
(f) Eel River:	
(1) The Eel River from 100 yards below Van Arsdale Dam to the confluence with Tomki Creek	Recreational
(2) The Eel River from the confluence with Tomki Creek to the middle of Section 22 T19N R12W	Scenic
(3) The Eel River from the middle of Section 22 T19N R12W to the boundary between Sections 7 and 8 T19N R12W	Recreational
(4) The Eel River from the boundary between Sections 7 and 8 T19N R12W to the confluence with Outlet Creek	Wild

WILD AND SCENIC RIVERS ACT

Rivers	Classification
(5) The Eel River from the confluence with Outlet Creek to the mouth at the Pacific Ocean	Recreational
(6) The South Fork of the Eel River from the mouth of Section Four Creek near Branscomb	Recreational
(7) The South Fork of the Eel River from Horseshoe Bend to the middle of Section 29 T23N R16W	Wild
(8) The South Fork of the Eel River from the middle of Section 29 T23N R16W to the confluence with the main Eel near Weott	Recreational
(9) Middle Fork of the Eel River from the intersection of the river with the southern boundary of the Middle Eel-Yolla Bolly Wilderness Area to the Eel River Ranger Station	Wild
(10) The Middle Fork of the Eel River from Eel River Ranger Station to Williams Creek	Recreational
(11) The Middle Fork of the Eel River from Williams Creek to the southern boundary of the northern quarter of Section 25 T22N R12W	Scenic
(12) The Middle Fork of the Eel River from the southern boundary of the northern quarter of Section 25 T22N R12W to the boundary between Sections 4 and 5 T21N R13W	Wild
(13) The Middle Fork of the Eel River from the boundary between Sections 4 and 5 T21N R13W to the confluence with main Eel at Dos Rios	Recreational
(14) The North Fork of the Eel River from the Old Gilman Ranch to the middle of Section 8 T24N R13W	Wild
(15) The North Fork of the Eel River from the middle of Section 8 T24N R13W to the boundary between Sections 12 and 13 T24N R14W	Recreational
(16) The North Fork of the Eel River from the boundary between Sections 12 and 13 T24N R14W to the confluence with main Eel	Wild
(g) Van Duzen River:	
(1) The Van Duzen River from the Dinsmore Bridge to the powerline crossing above Little Larrabee Creek	Scenic
(2) The Van Duzen River from the powerline crossing above Little Larrabee Creek to the confluence with Eel River	Recreational
(h) Lower American River: The Lower American River from Nimbus Dam to its junction with the Sacramento River	Recreational
(i) North Fork American River:	
(1) The North Fork from the source of the North Fork American River to two and one-half miles above the Forest Hill-Soda Springs Road	Wild
(2) The North Fork from two and one-half miles above the Forest Hill-Soda Springs Road to one-half mile below the Forest Hill-Soda Springs Road	Scenic
(3) The North Fork from one-half mile below the Forest Hill-Soda Springs Road to one-quarter mile above the Iowa Hill Bridge	Wild
(4) The North Fork from one-quarter mile above the Iowa Hill Bridge to the Iowa Hill Bridge	Scenic
(j) West Walker River:	
(1) West Walker River from Tower Lake to northern boundary of Section 10 (T5N, R22E)	Wild
(2) West Walker River From northern boundary of Section 10 (T5N, R22E) to the eastern boundary of Section 23 (T6N, R22E)	Scenic
(3) West Walker River from the eastern boundary of Section 23 (T6N, R22E) to the eastern boundary of Section 24 (T6N, R22E)	Recreational
(4) West Walker River from the eastern boundary of Section 24 (T6N, R22E)	Scenic

WILD AND SCENIC RIVERS ACT

Rivers	Classification
to the confluence with Little Walker River (5) West Walker River from the confluence with Little Walker River to the confluence with Rock Creek (6) Leavitt Creek from Leavitt Falls to the confluence with West Walker River	Recreational Scenic
(k) East Fork Carson River: East Fork Carson River from Hangman's Bridge crossing of state Highway 89 to the California-Nevada border	Scenic
(l) (1) The South Yuba River: (A) The South Yuba River from Lang Crossing to the confluence with Fall Creek (B) The South Yuba River from the confluence with Fall Creek to the confluence with Jefferson Creek below the town of Washington (C) The South Yuba River from the confluence with Jefferson Creek to Edwards Crossing (D) The South Yuba River from Edwards Crossing to its confluence with Kentucky Creek below Bridgeport (2) This subdivision shall become operative January 1, 2001.	Scenic Recreational Scenic Scenic
(m) Albion River: The Albion River from one-fourth mile upstream of its confluence with Deadman Gulch downstream to its mouth at the Pacific Ocean.	Recreational
(n) Gualala River: The main stem Gualala River from the confluence of the North and South Forks to the Pacific Ocean.	Recreational
(o) Cache Creek: (1) North Fork Section: From Highway 20 two miles downstream to the confluence of Cache Creek and the North Fork Cache Creek (2) Mainstem Section: (A) 1/4 mile downstream of Cache Creek Dam to the confluence with Davis Creek (B) Davis Creek confluence to 1 mile downstream of Davis Creek confluence (C) 1 mile downstream of Davis Creek confluence to western boundary of Section 6 T12N R4W (D) Western boundary of Section 6 to the confluence with Bear Creek (E) Bear Creek confluence to Camp Haswell	Scenic Wild Scenic Wild Scenic Recreational
(p) Mokelumne River: (1) Segment A1: North Fork Mokelumne River from 0.50 miles downstream of the Salt Springs Dam to Bear River confluence (2) Segment A2: North Fork Mokelumne River from the Bear River confluence to 0.50 miles upstream of the Tiger Creek Powerhouse (3) Segment B: North Fork Mokelumne River from 1,000 feet downstream of the Tiger Creek Afterbay Dam to State Highway Route 26 (SR-26) (4) Segment C1: North Fork Mokelumne River from 400 feet downstream of the small reregulating dam at the outlet of the West Point Powerhouse to the southern boundary of Section 12, T6N R12E (5) Segment C2: Section 12 boundary to confluence of the North and Middle Forks Mokelumne River (6) Segment D: Mokelumne River from the confluence of the North and Middle Forks to 300 feet upstream of the Electra Powerhouse (7) Segment E: Mokelumne River from 300 feet downstream of the small reregulating dam downstream of the Electra Powerhouse to the Pardee Reservoir flood surcharge pool at 580 feet elevation above mean sea level	Recreational Wild Scenic Wild Recreational Scenic Recreational

WILD AND SCENIC RIVERS ACT

5093.68. Special Treatment Areas; provisions applicable; Timber Operations stop orders.

(a) Within the boundaries of Special Treatment Areas adjacent to wild, scenic, or recreational river segments, all of the following provisions shall apply, in addition to any other applicable provision under this chapter or generally, whether by statute or regulation:

(1) A Timber Operator, whether licensed or not, is responsible for the actions of his or her employees. The registered professional forester who prepares and signs a timber harvesting plan, a timber management plan, or a notice of Timber Operations is responsible for its contents, but is not responsible for the implementation or execution of the plan or notice unless employed for that purpose.

(2) A registered professional forester preparing a timber harvesting plan shall certify that he or she or a qualified representative has personally inspected the plan area on the ground.

(b) In order to temporarily suspend Timber Operations that are being conducted within Special Treatment Areas adjacent to wild, scenic, or recreational rivers designated pursuant to Section 5093.54, while judicial remedies are pursued pursuant to this section, an inspecting forest officer of the Department of Forestry and Fire Protection may issue a written Timber Operations stop order if, operation is being conducted, or is about to be conducted, in violation of Chapter 8 (commencing with Section 4511) of Part 2 of Division 4, or of Rules and regulations adopted pursuant to those provisions, and that the violation or threatened violation would result in imminent and substantial damage to soil, water, or timber resources or to fish and wildlife habitat. A stop order shall apply only to those acts or omissions that are the proximate cause of the violation or that are reasonably foreseen would be the proximate cause of a violation. The stop order shall be effective immediately and throughout the next day.

(c) A supervising forest officer may, after an onsite investigation, extend a stop order issued pursuant to subdivision (b) for up to five days, excluding Saturday and Sunday, if the forest officer finds that the original stop order was issued upon reasonable cause. A stop order shall not be issued or extended for the same act or omission more than one time.

(d) Each stop order shall identify the specific act or omission that constitutes a violation or that, if foreseen, would constitute a violation, the specific timber operation that is to be stopped, and any corrective or mitigative actions that may be required.

(e) The Department of Forestry and Fire Protection may terminate the stop order if the Timber Operator enters into a written agreement with the department assuring that the Timber Operator will resume operations in compliance with the provisions of Chapter 8 (commencing with Section 4511) of Part 2 of Division 4, and with the Rules and regulations adopted pursuant to those provisions, and will correct any violation. The department may require a reasonable cash deposit or bond payable to the department as a condition of compliance with the agreement.

(f) Notice of the issuance of a stop order or an extension of a stop order shall be deemed to have been made to all persons working on the timber operation when a copy of the written order is delivered to the person in charge of operations at the time that the order is issued or, if no persons are present at that time, by posting a copy of the order conspicuously on the yarder or log loading equipment at a currently active Landing on the Timber Operations site. If no person is present at the site when the order is issued, the issuing forest officer shall deliver a copy of the order to the Timber Operator either in person or to the operator's address of record prior to the commencement of the next working day.

(g) As used in this section, "forest officer" means a registered professional forester employed by the Department of Forestry and Fire Protection in a civil service classification of forester II or higher grade.

(h) (1) Failure of the Timber Operator or an employee of the Timber Operator, after receiving notice pursuant to this section, to comply with a validly issued stop order is a violation of this section and is a misdemeanor punishable by a fine of not less than five hundred dollars (\$500), or by imprisonment for not more than one year in the county jail, or both. The person shall also be subject to civil damages to the state not to exceed ten thousand dollars (\$10,000) for each misdemeanor violation. However, in all cases, the Timber Operator, and not an employee of the operator or any

WILD AND SCENIC RIVERS ACT

other person, shall be charged with that violation. Each day or portion thereof that the violation continues shall constitute a new and separate offense.

(2) In determining the penalty for a Timber Operator guilty of violating a validly issued stop order, the court shall take into consideration all relevant circumstances, including, but not limited to, the following:

- (A) The extent of harm to soil, water, or timber resources or to fish and wildlife habitat.
- (B) Corrective action, if any, taken by the defendant.

(i) Nothing in this section prevents a Timber Operator from seeking an alternative writ as prescribed in Chapter 2 (commencing with Section 1084) of Title 1 of Part 3 of the Code of Civil Procedure, or as provided by any other provision of law.

(j) (1) If a Timber Operator believes that a forest officer lacked reasonable cause to issue or extend a stop order pursuant to this section, the Timber Operator may present a claim to the Department of General Services pursuant to Part 3 (commencing with Section 900) of Division 3.6 of Title 1 of the Government Code for compensation and damages resulting from the stopping of Timber Operations.

(2) If the Department of General Services finds that the forest officer lacked reasonable cause to issue or extend the stop order, the board shall award a sum of not less than one hundred dollars (\$100), nor more than one thousand dollars (\$1,000), per day for each day the order was in effect.

5093.70. Mill and Deer Creeks; findings and declarations; dam, reservoir, diversion, or other impoundment facilities; protection, restoration, or enhancement of fishery resources; water rights and historic use practices.

(a) The Legislature hereby finds and declares all of the following:

(1) Mill Creek and Deer Creek possess extraordinary resources in that they support one of the few remaining viable populations of wild spring-run chinook salmon in the Sacramento-San Joaquin River system. One essential component of the resources provided by these creeks is their exceptional water quality.

(2) Based on a review of comprehensive technical data, the Legislature has determined that potential beneficial uses must be balanced to achieve protection of the unique fishery resources and existing water rights of Mill Creek and Deer Creek in the manner specified in this section. In lieu of including Mill Creek and Deer Creek in the system, the continued management of stream resources in their existing natural condition consistent with the terms of this section represents the best way to protect the unique fishery of Mill Creek and Deer Creek. Maintaining the existing free flowing conditions of Mill Creek and Deer Creek to protect their fisheries is the highest and most beneficial use of the unappropriated waters of Mill Creek and Deer Creek within the segments designated in subdivisions (b) and (c), and is a reasonable use of water within the meaning of Section 2 of Article X of the California Constitution.

(b) No new dam, reservoir, diversion, or other water impoundment facility shall be constructed on Mill Creek from the headwaters of East Sulphur Creek within Section 15 T30N R4E to the United States Geological Survey gauging station in the northeast quarter of the northwest quarter of Section 6 T25N, R1W.

(c) No new dam, reservoir, diversion, or other water impoundment facility shall be constructed on Deer Creek from the headwaters in Section 11 T27N R5E to the United States Geological Survey gauging station in the northwest quarter of the northeast quarter of Section 23 T25N, R1W.

(d) Except for the maintenance of existing flood control facilities and Projects by public agencies or private landowners or emergency flood control activities or repairs required due to acts of God, provided that those activities or Projects do not interfere with the passage of migrating anadromous fish, no state agency shall assist or cooperate with, whether by loan, grant, license, or otherwise, any agency of the federal, state, or local government in the planning or construction of any dam, reservoir, diversion, or other water impoundment facility that could have an adverse effect on the free-flowing conditions of Mill Creek and Deer Creek, or on their wild runs of spring-run chinook salmon.

WILD AND SCENIC RIVERS ACT

(e) All state agencies exercising powers under any other provision of law with respect to the protection and restoration of fishery resources shall continue to exercise those powers in a manner that protects and enhances the fishery of the segments designated in subdivisions (b) and (c). In carrying out this subdivision, any exercise of powers shall be consistent with Section 5093.58.

(f) Nothing in this section shall prejudice, alter, affect in any way, delay, or interfere with the implementation or construction of any fishery restoration or improvement project that is authorized, required, or recommended pursuant to the Central Valley Improvement Act (Public Law 102-575) or the Upper Sacramento River Fisheries and Riparian Habitat Management Plan developed pursuant to Chapter 885 of the Statutes of 1986, or of any other fishery restoration or improvement project.

(g) Nothing in this chapter shall prejudice, alter, affect in any way, delay, or interfere with existing water rights; implementation of those rights; historic water use practices; and replacement, maintenance, repair, or operation of diversions and diversion facilities; or changes in the purposes of use, places of use, points of diversion, or ownership of existing water rights, except that no change shall operate to increase the adverse effect, if any, of the preexisting diversion facility or place or purpose of use upon the free flowing and natural character of the stream.

PROFESSIONAL FORESTERS LAW

PROFESSIONAL FORESTERS LAW

Public Resources Code Sections 750-783, Division 1, Administration, Chapter 2.5 Department of Forestry and Fire Protection.

Article 3. Professional Foresters.

750. Short title.

This article may be known and cited as the Professional Foresters Law.

751. Purpose.

The purpose of this article is to declare the existence of a public interest in the management and treatment of the forest resources and Timberlands of this state and to provide for the regulation of persons who practice the profession of forestry and whose activities have an Impact upon the ecology of forested landscapes and the quality of the forest environment, and through that regulation to enhance the control of air and water pollution, the preservation of scenic beauty, the protection of watersheds by flood and soil erosion control, the production and increased yield of natural resources, including timber, forage, wildlife, and water, and outdoor recreation, to meet the needs of the people.

752. Professional forester; scope of license and expertise.

(a) "Professional forester," as used in this article, means a person who, by reason of their knowledge of the natural sciences, mathematics, and the principles of forestry, acquired by forestry education and experience, performs services, including, but not limited to, consultation, investigation, evaluation, planning, or responsible supervision of forestry activities when those professional services require the application of forestry principles and techniques.

(b) A professional forester is licensed to perform forestry services only in those areas of expertise in which the person is fully competent as a result of training or experience. In order for a professional forester to fulfill all of their responsibilities with regard to a particular activity on a site, if the expertise that is prudently required exceeds the expertise possessed by the professional forester in that regard, the professional forester may need to utilize the services of other qualified experts, including, but not limited to, archaeologists, botanists, civil engineers, ecologists, fisheries biologists, geologists, hydrologists, land surveyors, landscape architects, range scientists, soil scientists, or wildlife biologists. This article shall not preclude those other environmental professionals from the application of their knowledge in their field of expertise outside the practice of forestry, as defined in Section 753.

753. Forestry.

"Forestry," as used in this article, refers to the science and practice of managing forested landscapes and the treatment of the forest cover in general, and includes, among other things, the application of scientific knowledge and forestry principles in the fields of fuels management and forest protection, timber growing and utilization, forest inventories, forest economics, forest valuation and finance, and the evaluation and mitigation of Impacts from forestry activities on watershed and scenic values, to achieve the purposes of this article. The practice of forestry applies only to those activities undertaken on forested landscapes. The professions specified in Section 772 are not practicing forestry when mitigating or recommending mitigation of Impacts from previous forestry activities on related watershed or ecological values within their area of professional expertise or when recommending those mitigations for proposed Timber Operations. However, public and private foresters are required to be licensed pursuant to this article when making evaluations and determinations of the appropriate overall combination of mitigations of Impacts from forestry activities necessary to protect all forest resources.

PROFESSIONAL FORESTERS LAW

754. Forested landscapes.

“Forested landscapes” means those tree dominated landscapes and their associated vegetation types on which there is growing a significant stand of tree species, or which are naturally capable of growing a significant stand of native trees in perpetuity, and is not otherwise devoted to non-forestry commercial, urban, or farming uses.

755. Person.

“Person” as used in this article means any natural person.

756. Supervision of forestry work by registered professional forester.

Nothing in this article prohibits any person from engaging in those activities otherwise restricted to professional foresters, certified specialists, or qualified but exempt certificants, provided a registrant is in charge of the professional practice or work of that person and all professional work or documents are done by or under the supervision of the registrant.

757. Landowner; exception.

This article does not apply to a landowner who is a natural person and who personally performs services of a professional forester, when those services are personally performed on lands owned by that person.

758. Professional forester not authorized to practice civil engineering, land surveying, or landscape architecture.

This article shall not be construed to authorize a registered professional forester to practice civil engineering as defined in Chapter 7 (commencing with Section 6700) of Division 3 of the Business and Professions Code or to practice land surveying as defined in Chapter 15 (commencing with Section 8700) of Division 3 of the Business and Professions Code or to practice landscape architecture, as defined in Chapter 3.5 (commencing with Section 5615) of Division 3 of the Business and Professions Code.

759. Rules and regulations.

The board may by regulation adopt such Rules and regulations pursuant to Chapter 4.5 (commencing with Section 11371) of Part 1 of Division 3 of Title 2 of the Government Code, as it determines are reasonably necessary to enable it to carry into effect the provisions of this article.

760. Meetings to consider registration matters; time.

The board shall consider matters pertaining to the registration of professional foresters at least once every six months at regular meetings and may, as necessary, meet solely for the purpose of considering matters to carry out the provisions of this article.

760.5. Staff personnel; executive officer; civil service.

The board may hire the clerical and secretarial employees, technical personnel, and other staff who are necessary and budgeted to properly assist the work of the board in carrying out the purposes of this article. This staff personnel shall be subject to the relevant system and procedures of the state civil service. The provisions of the State Civil Service Act contained in Part 2 (commencing with Section 18500) of Division 5 of Title 2 of the Government Code shall apply to that personnel. The executive officer shall be an employee exempt from civil service.

761. Records.

The board shall keep a complete record of all applications for registration and certification and the board’s action thereon.

PROFESSIONAL FORESTERS LAW

762. Certificates of specialization.

The board may by regulation provide for the issuance of certificates of specialization in such fields of specialization as the board may by regulation establish.

763. Examining committee; membership; duties.

(a) The board shall establish an examining committee of at least seven members composed of the following, who shall be appointed by the board and serve at its pleasure:

(1) Two public members with one selected from the membership of the board.

(2) At least four professional foresters in good standing representing a broad cross section of employment and expertise.

(3) At least one certified specialist registered pursuant to Section 772 in good standing. If a certified specialist is not available to serve on the committee, this position shall be replaced by an additional professional forester in good standing.

(b) The examining committee shall do all of the following:

(1) Examine all applicants for registration as professional foresters and for specialty certificates.

(2) Recommend to the board applicants for the license of professional forester and applicants for specialty certificates who fulfill the requirements of this article.

(3) Review complaints, which review may include independent investigations or expert witness evaluations, and make disciplinary recommendations to the board.

(4) Establish ad hoc committees as needed with representatives of certified specialists.

(5) Recommend to the board whether an independent certification program qualifies for recognition under Section 754.

(6) Recommend adoption of the Rules and regulations or changes in Rules and regulations which may be needed to effect this article.

764. Examining committee; compensation; expenses.

A person appointed to serve upon the examining committee shall receive, if requested, one hundred dollars (\$100) for each day during which that person is engaged in the performance of their official duties, except that the compensation of each member shall not exceed in any one fiscal year the sum of one thousand dollars (\$1,000). In addition, each member shall be reimbursed for necessary expenses incurred in the performance of their duties, including travel, at state rates.

765. Examining committee; appeals.

The examining committee shall adhere to the Rules and regulations of the board. An applicant for a license pursuant to this article who contends that they have been aggrieved by an action taken by the examining committee with respect to their qualifications may appeal to the board in accordance with Rules or regulations prescribed by the board. The board upon the appeal may administer an oral or written examination to the applicant as an aid in determining whether the applicant is qualified under this article.

766. Necessity of registration.

On and after July 1, 1973, it shall be unlawful for any person to act in the capacity of, or to use the title of, a professional forester without being registered pursuant to this article, unless exempted from the provisions thereof.

767. Application for license; fee.

An applicant for a license pursuant to this article shall apply to the board. Such application shall be accompanied by the payment of a fee in an amount fixed by the provisions of this article.

PROFESSIONAL FORESTERS LAW

768. Demonstration of experience and knowledge.

The board shall require an applicant to demonstrate such degree of experience and such general knowledge of the profession of forestry as the board deems necessary for the protection of the public.

769. Qualifications.

An applicant shall meet all of the following qualifications:

(a) Be of good moral character and have a good reputation for honesty and integrity.

(b) Furnish evidence of having completed seven years of experience in forestry work.

Possession of a degree of bachelor of science, or equivalent degree as determined by the board, with a major in forestry, shall be deemed equivalent to four years of experience in the actual practice of forestry work. At least three of the seven years of experience shall include having charge of forestry work, or forestry work under the supervision of a person registered, or qualified for, but exempt from, registration under the provision of this article. Work completed prior to July 1, 1973, shall qualify if it was under the supervision of a qualified forester, as defined in Section 754. The award of a master of forestry degree shall be acceptable as evidence of one year of such qualifying experience.

(c) Has successfully completed such examination or examinations as are prescribed by the board.

770. Examinations.

(a) Examinations shall be given by the board as often as it is deemed necessary, but at least every six months.

(b) The examination may consist of both written and oral portions. A grade of 75 percent shall be necessary for successful completion of the examination.

771. Reexamination.

An applicant failing in an examination may be examined again upon filing a new application and paying the application fee.

772. Certified specialist; registration; specialties.

Instead of being registered as a professional forester, an applicant may request to be registered as a certified specialist in one or more fields of forestry. Nothing in this article shall authorize the board to certify or otherwise license wildlife biologists, fisheries biologists, botanists, ecological restorationists, stream restorationists, hydrologists, or geologists. Registration in a specialty area does not prohibit a professional forester from providing services within that professional forester's area of expertise. Any public agency or professional society may submit for board recognition its independent certification program as full qualification without examination for the board's certificate of specialization. That certification as a specialist shall be granted provided the board determines the program fully protects the public interest in that area of practice encompassed by the program. Those certificants are subject to board registration and discipline with review by that specialty.

773. Licenses and specialty certificates; expiration.

Licenses and specialty certificates issued pursuant to this article shall be valid for two years and shall expire on July 1 of each alternating year.

774. Denial of license; reapplication conditions.

(a) Issuance of a license may be denied if sufficient evidence is received by the board of the commission or doing by the applicant of an act that, if committed or done by a licensee, would be grounds for the suspension or revocation of the licensee's license.

(b) In a decision denying an application, the board may provide that it will accept no future application from the applicant until the applicant complies with specified conditions. The board shall not require a condition that is not just and reasonable.

PROFESSIONAL FORESTERS LAW

775. Investigations; suspension or revocation of license.

The board may upon its own motion, and shall upon the verified complaint in writing of any person, cause investigation to be made of the actions of any person licensed pursuant to this article, and may temporarily suspend or permanently revoke the license of any person who is guilty of or commits any one or more of the acts or omissions constituting cause for disciplinary action.

776. Limitations of actions; law governing.

Any accusation against a registrant or a certificant shall be filed within five years after the act or omission alleged as the ground for disciplinary action. The proceedings under this article shall be conducted in accordance with Chapter 5 (commencing with Section 11500) of Part 1 of Division 3 of Title 2 of the Government Code and the board has all the powers granted in that chapter.

777. Mode of discipline.

(a) If the board finds against the registrant, the board, in its decision, may terminate all operations of the registrant during the period fixed by the decision, except those operations the board determines that the person may complete. The board may impose upon the registrant compliance with specific conditions as may be just in connection with the registrant's operations, and may further provide that, until the conditions are complied with, no application for restoration of the suspended or revoked registration shall be accepted by the board.

(b) The board shall provide public notice of the suspension or revocation pursuant to this section.

(c) The board may issue a private reprimand when a registrant commits a failure of responsibility that warrants a lesser level of discipline than suspension. The issuance of a private reprimand does not prohibit the board from using the subject of the private reprimand in an accusation, within the statute of limitations, seeking suspension or revocation resulting from a subsequent complaint, to establish a pattern of lesser failures of professional responsibility. If the evidence is insufficient to support a private reprimand or an accusation, the executive officer for registration may send a letter expressing the examining committee's concerns.

778. Causes for disciplinary action.

A registrant or certificant is subject to disciplinary action who:

(a) Has been convicted of a felony substantially related to the qualifications, functions, or duties of a registered professional forester. A conviction within the meaning of this section means a plea or verdict of guilty or a conviction following a plea of nolo contendere. Any action that the board is permitted to take following the establishment of a conviction may be taken when the time for appeal has elapsed or when an order granting probation is made suspending the imposition of sentence, irrespective of a subsequent order under Section 1203.4 of the Penal Code.

(b) Has been found guilty by the board of any deceit, misrepresentation, fraud, material misstatement of fact, incompetence, or gross negligence in their practice.

(c) Has been guilty of fraud or deceit in obtaining their registration or certification.

(d) Aids or abets a person in the violation of this article.

(e) Fails in any material respect to comply with this article.

778.5. Criteria development; disciplinary action.

The board shall develop criteria to determine whether a felony is substantially related to the qualifications, functions, or duties of a registered professional forester in order to aid it when considering the denial, suspension, or revocation of a license.

779. Violations; misdemeanor.

Any person who violates any of the provisions of this article is guilty of a misdemeanor.

PROFESSIONAL FORESTERS LAW

780. Deposit of fees.

The fees received pursuant to this article shall be deposited in the Professional Forester Registration Fund in the State Treasury, which fund is hereby created.

781. Use of fees; emergency expenditure.

All fees received pursuant to this article shall be available, when appropriated by the Legislature, for the administration of this article; provided, that in the event that moneys need to be expended from the Professional Forester Registration Fund for emergencies for which no appropriation, or an insufficient appropriation, has been made by law, and which in the judgment of the Director of Finance constitutes a case of actual necessity, but limited to purposes of administration of this article that have been specifically approved by the Legislature in budget acts or other legislation, the Director of Finance may authorize an emergency expenditure in an amount determined by the Director of Finance from the fund; provided, further, that the Director of Finance shall file with the Joint Legislative Budget Committee within 10 days after approval of the emergency expenditure, copies of all executive orders, expenditure authorizations, and allotments made pursuant to this section, and stating the reasons for, and the amount of, those expenditures.

782. Fee schedule.

The board shall establish by regulation the amount of fees within the following ranges, and based on a determination by the board of the amount of revenues reasonably necessary to carry out this article:

(a) The application fee for registration or for each certificate of specialization shall be not less than fifty dollars (\$50) and not more than two hundred dollars (\$200).

(b) The registration fee and certificate of specialization fees and renewal fees shall be not less than twenty-five dollars (\$25) and not more than two hundred fifty dollars (\$250) per year. Every licensed person shall, on or before July 1 of the year of expiration, pay the renewal fee.

(c) The fee for the issuance of a duplicate display registration document or certificate of specialization shall be not less than five dollars (\$5) and not more than twenty-five dollars (\$25).

(d) The penalty fee for failure to apply for a renewal shall be not less than ten dollars (\$10) and not more than twenty-five dollars (\$25) for each month of delinquency. In return for the payment of the renewal fee and any applicable late fees, a renewal registration card shall be issued.

(e) A registrant or certificant may, upon written notice to the board, be granted a withdrawal period without penalty not to exceed five years. A reinstatement application shall be accompanied with a fee of not less than fifteen dollars (\$15) and not more than fifty dollars (\$50), for registration or each certificate of specialization.

783. Default in payment of renewal fee; effect.

In case a person defaults in payment of the renewal fee, the person's registration may be revoked by the board on 60 days' notice in writing from the board, unless within this time the fee is paid, together with penalty, not exceeding the amount fixed by this article. Upon payment of the fee and penalty within one year, the board shall reinstate the person's registration.

REGISTRATION OF PROFESSIONAL FORESTERS RULES.

REGISTRATION OF PROFESSIONAL FORESTERS RULES.

Title 14, California Code of Regulations, Chapter 10. Registration of Professional Foresters.

Article 1. General Provisions

1600. Definitions.

For the purposes of the Rules and regulations contained in this chapter, the term:

“Board” means the State Board of Forestry and Fire Protection.

“Certified Specialist” refers to a person who holds a valid certification in a specialty created by the Board.

“Code” or “PRC” refers to the Public Resources Code, unless otherwise specified.

“Committee” or “PFEC” means the Professional Foresters Examining Committee.

“Executive Officer” refers to the Executive Officer, Foresters Licensing.

“Forest Resources” means those uses and values associated with, attainable from, or closely tied to, forested landscapes, and includes but is not limited to aesthetics, fish, forage, recreation, soil, timber, water and watersheds, wilderness, and wildlife.

“Registered Professional Forester” or “RPF” refers to a person who holds a valid license as a professional forester pursuant to the provisions of the code.

1601. Board of Forestry and Fire Protection Address.

All correspondence relating to Professional Foresters Registration, including remittances and renewal fees, shall be directed to the principal offices of the State Board of Forestry and Fire Protection located in the Resources Building, 715 P Street, Sacramento, California 95814, or by mail to P.O. Box 944246, Sacramento, California 94244-2460.

1601.1. Determination of Deadlines.

Any due dates or time frames for submission of fees, completed forms, or correspondence is determined by date of personal delivery at Board office or date of postmark by commercial carrier.

1602. Professional Forestry Practice Defined.

(a) The phrase “act in the capacity of...a professional forester...” pursuant to Public Resources Code (PRC), Section 766 refers to any person who is working in a responsible position as an individual or through the supervision of others, and performs services on forested landscapes applicable to “forestry” as defined in PRC, Section 753 and clarified herein. Forestry requires specific knowledge of forestry principles for providing advice to, or management for, employers, clients, or others, through consultation; through conduct of investigations in forestry matters which have potential environmental effects, or are for site-specific purposes; through evaluation of forest properties; and through the planning or execution of forest programs, management, operations, and/or treatment.

(b) A Registered Professional Forester (RPF) shall perform forestry services only in those subjects in which he or she is competent by training or experience. Thus, for an RPF to accomplish a site-specific forestry project where the RPF’s prudent level of expertise is surpassed, that RPF may need to utilize the services of other qualified experts including but not limited to geologists, landscape architects, engineers and land surveyors, archaeologists, botanists, ecologists, fisheries biologists, stream restorationists, wildlife biologists, hydrologists, range scientists, soil scientists, and certified specialists established pursuant to PRC 772.

(c) In carrying out PRC, Section 772, a Certified Specialist shall perform only those services in his or her specialty as described in Chapter 10, Division 1.5, Title 14 of the California Code of Regulations. Nothing in this section shall preclude certified specialists or the other environmental professionals in subsection (b) from the application of scientific knowledge in their field of expertise outside the practice of forestry.

REGISTRATION OF PROFESSIONAL FORESTERS RULES.

1602.1. Identity Required of Registered Professional Forester in Charge.

Any letter or document which offers to perform or implies the performance of any professional forestry work must identify by name and license number the forester (RPF) who will be in charge of such work when it is performed. An unregistered assistant acting in the capacity of a professional forester, as defined in 14 CCR 1602 other than on federally owned lands shall be supervised by a forester (RPF). Work plans and documents reporting work done by or under the supervision of a forester (RPF) shall bear the signature and license number of the forester (RPF) responsible for said plans, work and reports.

1603. Seal.

A seal may be used by a registrant. It shall be of the design shown here and shall not be less than one and one-half (1½) inches in diameter.



1604. Registration limited to Natural Persons.

Registration shall be determined on the basis of individual personal qualifications. No firm, company, partnership, or corporations will be issued a professional foresters license or specialty certificate.

1605. Fees.

(a) All fees required by provisions of the Code and Rules of the Board shall be transmitted by money order, bank draft, credit card, or check and shall be made payable to Professional Foresters Registration.

(b) The following schedule of fees is hereby adopted pursuant to section 782 of the Code.

- (1) Application for Registration and License as a Professional Forester \$200
- (2) Annual Rate for License as a Professional Forester 175
- (3) Application for Exam for Specialty Certificate 200
- (4) Annual rate for Specialty Certificate 65
- (5) Duplicate License or Specialty Certificate 25
- (6) Renewal of License as a Professional Forester 350
- (7) Renewal of Specialty Certificate 130
- (8) Penalty fee for failure to apply for renewal as a Licensee or for a specialty certificate is \$25 for each full month of delinquency not to exceed \$150.00 total penalty fee. . . 25
- (9) Reinstatement Application following Withdrawal 50
- (10) Renewal of License for Professional Foresters with 30 or more years of registration as a Professional Forester. 250

(c) The renewal fee for registration and/or certification as a forestry specialist shall be waived when a license or certificate is issued less than ninety (90) days before the date on which it will expire.

(d) Application fees for registration, certification as a forestry specialist, or reinstatement following withdrawal, shall be retained by the Board regardless of the disposition of the application.

(e) The Professional Foresters Examining Committee shall review, at least once every five years, the availability of funds necessary to administer this Chapter (Chapter 10 of Division 1.5 of Title 14

REGISTRATION OF PROFESSIONAL FORESTERS RULES.

of the California Code of Regulations) and recommend any fee changes necessary for continued administration.

1606. Address Change.

Applicants for registration or holders of a certificate of registration and license, shall notify the Board in writing at its Sacramento office within ten days of any address changes, giving both the old and new address.

1607. Issuance, Expiration and Renewal of Licenses and Certificates.

(a) Professional Foresters Licenses and Specialty Certificate shall be renewed on alternating years with odd-numbered licenses and certificates expiring on July 1 of odd-numbered years and even-numbered licenses and certificates expiring on July 1 of even-numbered years.

(b) Newly issued Professional Foresters Licenses and Specialty Certificates shall be valid, on payment of the appropriate fee, from the date of issuance to July 1 of odd-numbered years for odd-numbered licenses and certificates and July 1 of even-numbered years for even-numbered licenses and certificates. The appropriate fee for a newly issued license or certificates shall be based on proration of the annual rate for the license as provided in §1605(b)(2) or certificates as provided in §1605(b)(4) against the term of the newly issued license or certificate. Individuals reinstating their license or certificate from withdrawal shall pay the full renewal fee regardless of the actual length of time remaining in the applicable two year renewal cycle.

(c) Licenses and specialty certificates are not valid unless fees are paid prior to the expiration date. Written notification of delinquency shall be mailed no later than September 1 to those persons whose license or specialty certificate(s) expired. Individuals have sixty (60) days from the date of mailing the delinquency notice to reinstate the license or certificate by paying renewal fees and penalties, after which the Board shall revoke the license or certificate. By paying all renewal fees and penalties, within one year of the renewal date, the individual may reinstate a license or certificate(s) revoked because of delinquency.

1608. Withdrawals.

(a) The Board may, upon written request of a currently paid up licensee, grant a withdrawal of a forester's license or specialty certificate for a period not to exceed five years at any one time without penalty. The request shall state the reason for withdrawal, and the length of time for which withdrawal is requested. During withdrawal, the person shall not call him or herself a "professional forester" or provide professional forester services of any kind for pay or otherwise in California, or use their registration number anywhere.

(b) Withdrawals shall be granted only for good and sufficient reasons, including, but not limited to the following:

- (1) Active duty in the armed services of the United States.
- (2) Professional service exclusively outside of the State of California.
- (3) Ill health or disability.
- (4) Registration as a full time student in a college or university.
- (5) Retirement may be used as a reason only one time.

(c) Registrants shall be notified in writing whether the request for withdrawal is granted or denied.

(d) Prior to expiration of withdrawal status, notification of required reinstatement will be sent during the regular renewal period. If an application for reinstatement, along with the required fees prescribed, is not presented to the executive officer within the specified withdrawal period, the Board shall revoke the license or certificate.

(e) Reinstatement of a license shall be denied if:

(1) The original withdrawal occurs as part of a stipulated agreement settling a formal disciplinary case, or

(2) An RPF requested license withdrawal after being notified by the executive officer that a disciplinary investigation was being conducted concerning the RPF's license, and that the

REGISTRATION OF PROFESSIONAL FORESTERS RULES.

investigation and any disciplinary proceedings associated with it have not been concluded, including any penalties being imposed.

1610. Delegation of Certain Functions.

(a) The power and discretion conferred by law upon the Board to receive and file accusations; issue notices of hearings, statements to respondent and statements of issues; receive and file notices of defense; determine the time and place of hearings under Section 11508 of the Government Code, issue subpoenas and subpoenas duces tecum, set and calendar cases for hearing and perform other functions necessary to the dispatch of the business of the Board in the Government Code prior to the hearing of such proceeding; and the certification and delivery of mailing of copies of decisions under Section 11518 of said Code are hereby delegated to and conferred upon the Executive Officer, or, if absent from the office of the Board, another person designated by the Executive Officer.

(b) Nothing herein prohibits the Executive Officer from re delegating duties to their subordinates as provided in Section 18572 of the Government Code.

(c) Unless otherwise directed by the Board, the Executive Officer may work directly with the Committee on those matters which are pertinent to the Professional Foresters Law, Section 750 et seq. of the Code. The Executive Officer may be designated by the Committee to report to the Board on its behalf.

1610.1. Committee Meeting and Reports.

(a) The Committee shall meet and report to the Board at least once every six months, or more frequently as necessary to fulfill its responsibilities to the Board under Section 763 of the Code, and shall refer to the Board all matters requiring Board approval.

(b) Reports and recommendations made by the Committee to the Board for approval or rejection by the Board and any action recommended or approved by the Board shall be carried out by the chairperson or a member of the Committee or by the Executive Officer in the manner approved by the Board.

1611. Reciprocity.

A Professional forester who is licensed in another state which maintains requirements and qualifications which are equal to or superior to those of the State of California may, upon successfully passing a special examination prescribed by the Board and payment of the required fees be registered as a professional forester, provided that said state observes these same Rules of reciprocity.

1612. Discipline.

The Committee may, upon its own motion, and shall upon motion of the Board or upon the verified complaint in writing of any person, cause investigation to be made of the actions of any person licensed as a professional forester or Certified Specialist. The committee shall make recommendations to the Board for any action provided by law.

1612.1 Disciplinary Guidelines.

The Board establishes these guidelines to ensure that consequences in any disciplinary action of a Registered Professional Forester or Certified Specialist are known, and to facilitate uniformity of penalties. While recognizing that Administrative Law Judges must be free to exercise their discretion in a particular case, the Board desires that these guidelines be followed to the extent possible, and that any departures therefrom be noted and explained in the proposed decision.

The Board further desires that matters in extenuation and mitigation, as well as those in aggravation, be fully considered and noted in the proposed decision. The primary importance is the adverse effect the Registered Professional Forester's or Certified Specialist's actions had, or will continue to have, on the protection of the public interest.

REGISTRATION OF PROFESSIONAL FORESTERS RULES.

(a) If convicted of a felony as defined in Section 778(a) and governed by Section 778.5, Public Resources Code, ranges of disciplinary action for conviction(s) are:

Maximum: Revocation of the license.

Minimum: Revocation stayed for 2 years on the following conditions:

(1) Actual suspension for 1 year.

(2) The respondent shall obey all laws and regulations related to the practice of forestry.

(b) If found guilty of fraud, deceit, or gross negligence in his or her practice, governed by Public Resources Code, Section 778(b), the ranges of disciplinary action for the violation(s) are:

Maximum: Revocation of the license or specialty certificate.

Minimum: 6 months suspension stayed for 1 year on the following conditions:

(1) Actual suspension for 60 days.

(2) Within one year of the effective date of the Board's decision, the respondent shall successfully complete a training program, approved in advance by the Board as being specifically related to the area(s) of professional failure.

(3) Respondent must practice, for up to one year, with the review of work products by a Registered Professional Forester, or other specialist, as approved by the Board.

(4) The respondent shall obey all laws and regulations related to the practice of forestry.

(c) If found guilty of misrepresentation or material misstatement of fact in his or her practice, governed by Public Resources Code, Section 778(b), the ranges of disciplinary action for the violation(s) are:

Maximum: Revocation of the license or specialty certificate.

Minimum: 90 days suspension stayed for 1 year with 15 days actual suspension, and one or more of the following:

(1) Within one year of the effective date of the Board's decision, the respondent shall successfully complete a training program, approved in advance by the Board as being specifically related to the area(s) of professional failure.

(2) Respondent must practice, for up to one year, with review of work products by a Registered Professional Forester, as approved by the Board.

(3) The respondent shall obey all laws and regulations related to the practice of forestry.

(d) If found guilty of incompetence governed by Section 778(b), Public Resources Code, in his or her practice, the ranges of disciplinary action for violation(s) are:

Maximum: Revocation of the license or specialty certificate.

Minimum: Revocation stayed up to 3 years with license or specialty certificate suspension until the completion of all of the following conditions:

(1) The respondent shall successfully complete a training program, approved in advance by the Board, specifically related to the area of incompetency, and

(2) The respondent shall take and be notified of passing the Registered Professional Foresters examination, or related certified specialty, and

(3) Respondent must work, at least six months full time equivalent, under the supervision of a Registered Professional Forester or certified specialist, with review of work products, as approved by the Board.

(4) The Respondent shall obey all laws and regulations related to the practice of forestry.

(e) If found guilty of fraud or deceit in obtaining a license or specialty certificate, governed by Section 778(c), Public Resources Code, the ranges of disciplinary action for violation(s) are:
Recommended Action: Revocation of license.

(f) If found guilty of aiding or abetting a violation of, or material failure to comply with the provisions of the Professional Foresters Law, governed by Section 778(d) and (e), Public Resources Code, the ranges for disciplinary action for violation(s) are:

Maximum: Revocation of the license or specialty certificate.

REGISTRATION OF PROFESSIONAL FORESTERS RULES.

Minimum: 15 days actual suspension

(g) If found guilty of failure to materially comply with any provision of the Professional Foresters Law, the Board may issue a private reprimand when the respondent commits a failure of responsibility which warrants a level of discipline lesser than suspension. If the evidence is insufficient to support a private reprimand or an accusation, the Executive Officer may send a confidential letter expressing the committee's concerns. If there are insufficient grounds for discipline, the Executive Officer shall send a letter of exoneration to the respondent.

(h) In any of the above actions, the respondent shall submit such special reports as the Board may require. Said reports shall be designed to provide information as to those facets of his/her work which resulted in the disciplinary action.

1612.2. Notification of Disciplinary Action.

(a) Conditions of staying an order which suspends or revokes a license or specialty certificate on any of the grounds for disciplinary action specified in Section 778, Public Resources Code, or specialty certificate shall require:

(1) Respondent to submit to the Board, not later than thirty (30) days after the decision becomes effective, a complete list of all business and/or client names, addresses, and phone numbers with whom a current contractual or employment relationships exists. Furthermore, respondent shall notify the Board within ten (10) days of any new contractual or employment relationships over the duration of the stayed order. This information may be used to aid the Board in monitoring the performance of respondent over the period of the stayed order.

(2) Board to notify each business and/or client name submitted, or at its option require respondent to notify with Board approved language and proof of notification, of the offense(s), findings and discipline imposed.

(b) The Board shall provide public notice of disciplinary actions. The Board shall comply with the following standards when providing public notice:

(1) When the RPF or Certified Specialist is exonerated, their name and the specifics of the cases will not be made public. A summary of the case will be noticed in "Licensing News", and will include the following:

(A) Case number.

(B) Allegation: citing possible cause(s) of action under 14 CCR §1612.1.

(C) Authority: citations of applicable statutory and regulatory sections.

(D) Action: announcement of the exoneration and a general summary of the facts of the case.

(2) When disciplinary action results in the issuance of a PFEC Letter of Concern or Private Board Reprimand, the name of the RPF or Certified Specialist and license or specialty certificate number and specifics of the case will not be made public. A summary of the case will be noticed in "Licensing News", and will include the following:

(A) Case number.

(B) Allegation: citing possible cause(s) of action under 14 CCR §1612.1.

(C) Authority: citations of applicable statutory and regulatory sections.

(D) Action: announcement of the disciplinary action taken and a general summary of the facts of the case.

(3) When disciplinary action results in license or specialty certificate suspension or revocation, the name of the RPF or Certified Specialist and the specifics of the case will be made public. A summary of the case will be noticed in the "Daily Recorder", "Licensing News", the meeting minutes of the Board, and announced in open session of the Board meeting at which the discipline was approved. These notices will include the following:

(A) Case number.

(B) Name and license number of RPF or Certified Specialist.

(C) City of business at the time of notice.

(D) Allegation: citing possible cause(s) of action under 14 CCR §1612.1.

REGISTRATION OF PROFESSIONAL FORESTERS RULES.

(E) Authority: citations of applicable statutory and regulatory sections.

(F) Action: announcement of the disciplinary action taken and a specific summary of the facts of the case.

(4) The information summarized in “Licensing News” under (b)(1), (b)(2), and (b)(3) above shall be available upon request to the public.

(c) The Board may provide notice to the news media of disciplinary actions. The Board shall comply with the following standards when providing notice to the media.

(1) Media releases shall occur in all instances when disciplinary action results in the following:

(A) Suspension or revocation based on any of the following cause(s):

(i) Conviction of a felony as defined in Section 778(a) and governed by Section 778.5 of the Public Resources Code.

(ii) Fraud.

(iii) Deceit.

(iv) Gross negligence.

(v) Incompetence.

(B) The PFEC has recommended revocation or a suspension greater than 30 days for any cause under 14 CCR §1612.1.

(2) The media release shall be approved by the by the Board, and shall contain all information cited in subsection (b)(3).

(3) The media release shall be submitted to a newspaper of general circulation in the county(ies) where the infraction(s) occurred.

1613. Felony Substantial Relationship Criteria.

For the purposes of denial, suspension or revocation of a license pursuant to Division 1, Chapter 2.5, Article 3, Sections 774, 775, and 778 of the Public Resources Code (PRC), a felony shall be considered to be substantially related to the qualifications, functions, or duties of an RPF or Certified Specialist, if, to a substantial degree, it evidences present or potential unfitness to perform the functions authorized by Article 3 of the Public Resources Code.

Such felonies may include, but not be limited to; felony convictions which demonstrate dishonesty or breach of fiduciary responsibility or which involve any of the following:

(a) violations of PRC 778, or felony sections of the Business and Professions Code, Health and Safety Code, and Public Contracts Code;

(b) damage to natural resources including, but not limited to, arson;

(c) violations related to:

(1) Division 1, Chapter 2.5, Article 3 of the Public Resources Code or

(2) Division 4, Part 2, Public Resources Code, or

(3) Division 1.5, Title 14, California Code of Regulations.

1614. Criteria for Rehabilitation.

When considering the specified conditions of denial or reinstatement from suspension or revocation of a license or specialty certificate, the Board, in evaluating the rehabilitation of the applicant and present eligibility for a license or specialty certificate will consider the following criteria:

(a) The nature and severity of the act(s) or crime(s) under consideration as grounds for denial or reinstatement.

(b) Evidence of any act(s) committed subsequent to the act(s) or crime(s) under consideration for grounds for denial or reinstatement which also could be considered as grounds for denial or reinstatement .

(c) The time that had lapsed since the commission of the act(s) or crime(s).

(d) The extent to which the applicant, licensee, or Certified Specialist has complied with any terms of parole, probation, restitution, or any other sanctions lawfully imposed against the applicant.

REGISTRATION OF PROFESSIONAL FORESTERS RULES.

- (e) Evidence, if any, of rehabilitation submitted by the applicant.

Article 2. Applications.

1620. Applications.

- (a) Applications for registration as a professional forester or as a certified specialist shall be:
 - (1) Filed on a form prescribed by the Board
 - (2) Filed at the Sacramento office of the Board, and accompanied by the required application fee.
 - (3) Subscribed and certified to “under penalty of perjury” as provided by Section 2015.5, Code of Civil Procedure.
 - (4) Typewritten, except that applicants located without access to typewriters, may so state, and submit applications printed legibly by hand.

1620.1. Professional and Personal References.

An applicant shall include in the application for registration the names and addresses of two qualified foresters as references, who are familiar with the professional work and three responsible members of the community who are not foresters who can attest to the character and business integrity of the applicant. Such references may be consulted by the examining committee regarding the qualifications of the applicant.

1620.2. Application Processing.

- (a) The applicant shall be informed in writing by the Executive Officer, within 90 days of receipt of the application, whether such application is complete and accepted for filing or is deficient and what specific information is required. The Examining Committee may, at a later time, request clarification of information contained in the application or supporting documents as provided in 1620.3.
- (b) The applicant shall be informed, in writing, of the Board decision on registration within 360 days of filing. Postponement of the examination by the applicants shall extend this deadline in the same amount of time as the postponement.
- (c) The actual minimum, median and maximum processing times for an application from the time of receipt of the application until the board makes a final decision on the application are:
 - (1) Minimum: 118 days
 - (2) Median: 152 days
 - (3) Maximum: 360 days

1620.3 Evidence of Qualifying Experience.

- (a) The application, and any supporting documentation, shall present evidence of qualifying experience in forestry work, and any educational degree(s) substituted therefor:
- (b) The qualifying experience for registration shall be computed to the final application filling date for each examination.
- (c) Applicants claiming credit under educational provisions shall document such claims with an official transcript of record or comparable document or certified copy thereof, issued by the educational institution awarding the degree. Such records or transcripts shall be sent by the institution directly to the Board.

1621. Evaluation of Qualification to Take the Examination.

In complying with Sections 768 and 769(b) of the Code, the standards set forth in Sections 1621.1, 1621.2, 1621.3, 1621.4, 1622, and 1622.2 of this article are used to evaluate qualifications for authorization to take the exam.

REGISTRATION OF PROFESSIONAL FORESTERS RULES.

1621.1. Qualifying Forestry Work Experiences.

(a) "Forestry work," within the meaning of Section 769 of the Code, includes those activities which demonstrate professional competence in the science, art, and practice of managing and using for human benefit while protecting the public interest, the natural resources that occur on and in association with, forest land.

(b) Forestry experience qualifying to take the exam shall demonstrate an increasing level of responsibility and complexity over the required time, and is more particularly classified as:

(1) Forest management, which includes that branch of forestry concerned with overall administration in forest economics, legal and social aspects; forest mensuration, forest regulation, and the development of access for protection and management of the resource.

(2) Silviculture, which includes the science and practice of controlling the composition, constitution, and growth of forests, including also stand improvement, forest nursery production, the techniques of seeding and planting, and reforestation.

(3) Forest protection, which includes the prevention and control of damage to forests, inclusive of control of forest pests; the prevention and control of wildfire; the protection of soils from erosion, and the reduction and repair of damage resulting from all of these and those related to climatic agent. Up to two years of the activities in this subsection qualify except when Section 1622(c) are met.

(4) Forest utilization which includes scaling, and logging involving felling, bucking, choker setting, and Skidding/Yarding. Up to two years of the activities in this subsection qualify except when Section 1622 of this article applies: additional time can qualify when conditions in 1622(c) are met.

(5) Forest and watershed management planning, initiated and carried out in:

(A) forest working plans,

(B) forest practice standards,

(C) management contracts,

(D) litigation reports and testimony,

(E) trespass,

(F) the development, maintenance and protection of wildlife habitat and forest

range resources,

(G) forest recreation and environmental studies, and

(H) reconnaissance and mapping in conservation of forest and watershed lands and the yield thereof, including the investigation of wildlands soils.

(6) Other forest activities, including timber appraisals, forestry research, urban forestry, and teaching college or university courses in forestry.

1621.2. Non-Qualifying Forestry-Related Work Experience.

Some forestry-related activities are not considered "forestry work" experience within the meaning of Section 769 of the Code: landscape gardening; horticulture; arboriculture; tree surgery; loading and hauling of logs or other forest products, operations of wood manufacturing or remanufacturing plants; fire lookouts, dispatchers, and fire equipment operators; and agricultural pursuits not related to tree growing.

1621.3. Work Experience Obtained While In a Degree Program.

The following criteria applies to substitutions for forestry work experience toward the seven year requirement. No combination of education and work experience may be counted as more than twelve (12) months for any consecutive twelve month period. Thus, periods worked while in a substituted educational degree program do not qualify because this time is already included in the degree. Work periods that exceed the amount of degree time substituted do qualify.

REGISTRATION OF PROFESSIONAL FORESTERS RULES.

1621.4. Substitution of Education for Experience.

(a) For the purpose of this article and in accordance with Section 769(b) of the Code, a course of study shall be deemed a major in forestry only (1) if the awarding institution specifically designated the course of study as a major in forestry or a direct derivative thereof such as a major in forest management or a major in forest science, and (2) if it provides the significant concepts in a working knowledge of forest biology, forestry in the social context, forest resources inventory, forest ecosystem management, and forest resources administration. The forest courses presenting such concepts and working knowledge shall be at a level qualifying for transfer credit in a program leading to the Bachelor of Science degree with a major in forestry at either the University of California, Berkeley, California Polytechnic State University at San Luis Obispo, or at Humboldt State University.

In accordance with these standards, a “major in forestry” for the purposes of this act are majors in forestry offered in California, at the University of California, Berkeley, California Polytechnic State University at San Luis Obispo, and Humboldt State University and the programs in forestry offered in other states, which meet the above standards including such programs offered at universities accredited at the time of applicant graduation by the Society of American Foresters (SAF) as of their most current list. The list(s) may be obtained from Professional Foresters Registration, or SAF, 5400 Grosvenor Lane, Bethesda, Maryland, 20814-2198.

(b) The following degrees are deemed the equivalent of four years of forestry experience:

(1) A Bachelor of Science degree with a Major in Forestry, or possession of a Bachelor of Science in Forestry degree from any college or university in the United States or Canada.

(2) A degree in forestry, however designated, from a foreign college or university based on completion of a program of at least four years of university level work with a major in forestry, subject to review and favorable recommendation of the Examining Committee.

(3) A Master of Forestry degree awarded an applicant who holds either a Bachelor of Science degree or a Bachelor of Arts degree with a major in a field other than forestry may submit such evidence as a comparable degree to the Bachelor of Science in Forestry degree.

(c) The Committee shall evaluate and determine, on a case-by-case basis, which other college or university degrees may be substituted as qualifying forestry work experience. In no case can any of the following be combined for more than four years substitution.

(1) A Bachelor of Science degree in a forestry-related field is not equivalent to a Bachelor of Science degree with a major in forestry. No more than two (2) years shall be substituted for such forestry-related fields including, but not limited to , wood science and technology, wildlife management, range management, soil science or conservation of natural resources.

(2) A Master of Science or Doctor of Philosophy degree in forestry or forestry-related fields can be substituted only when subsection 1621.4(b) of this article does not apply. No more than one (1) year for each of these degrees shall be substituted. A Master of Forestry degree is substituted for only one (1) year unless subsection 1621.4 (b)(3) of this article applies.

(3) An Associate of Science or Associate of Arts with a “major in forestry” from one of the two-year colleges recognized at the time of applicant graduation by the Society of American Foresters can be substituted for two (2) years’ experience. The lists(s) may be obtained from Professional Foresters Registration, or SAF, 5400 Grosvenor Lane, Bethesda, Maryland, 20814-2198.

1622. Three Years of “Having Charge of Forestry Work,” or “Under the Supervision of a Person Registered.”

(a) The minimum of three (3) years “having charge of forestry work,” or “forestry work under the supervision of a person registered, or qualified for, but exempt from registration” as specified in Sections 757 and 769(b) of the Code is evaluated using the criteria in subsection (b), below.

(b) “Supervision” shall be deemed adequate to meet the three year requirement if it includes the following elements:

(1) Supervisor is able to hire and fire or effectively recommend same, or is able to clearly withdraw professional responsibility for forestry related matters.

REGISTRATION OF PROFESSIONAL FORESTERS RULES.

(2) Supervisor must perform regular and timely quality control, work review and inspection, both in the office and in the field, and be able to take, or effectively recommend, corrective actions where necessary. The frequency of review, inspection and guidance shall take into consideration the experience of the non-RPF and technical complexity of the job, but shall be sufficiently frequent to ensure the accomplishment of work to professional standards.

(c) The following limitations apply to the requirement of three years “having charge of forestry work,” or “under the supervision of a person registered.”

(1) Forestry work stated in subsection 1621.1(b)(3) and 1621.1(b)(4) of this article must be performed at planning and supervision levels; scaling does not qualify unless it is part of an apprentice trainee program under the direct supervision of an RPF.

(2) Only the Master of Forestry degree, in conjunction with a qualifying Bachelor of Science degree with a major in forestry, may be substituted for one of the three years required as provided in Section 769 of the Code.

1622.2. Contracting Forestry Work Experience.

Forestry experience obtained while working as a contractor may be claimed as having charge of forestry work, or forestry work under the supervision of a person registered, or qualified but exempt from, registration provided:

(a) The applicant submits a copy of the contract and any documentation necessary to verify the appropriateness of experience.

(b) The contract required the work of the contractor to be supervised as stated in Section 1622(b) of this article.

(c) The contract or documentation specifies the various items of supervision including, but not limited to: training; frequency of contact both for professional and contract compliance purposes; office and field review; and how corrective actions can be taken.

(d) The contract or documentation has the names, current addresses, and phone numbers of each qualified forester who directly carries out this supervision. If the supervisor is Registered, the license number must be included.

1626. Denial of Application.

If, in the judgment of the committee, based upon the evidence submitted, the applicant lacks the required qualifications, the committee shall deny the application without prejudice. The applicant shall be notified in writing of the reasons for denial and of the right to appeal such denial as provided in Section 1647 of this article.

1628. Abandoned Applications.

In the absence of special circumstances, the Board shall consider an application abandoned when:

(a) The applicant fails to submit a registration fee or specialty fee within sixty (60) days of the date of the letter of acceptance for registration or certification.

(b) The applicant fails to appear for a scheduled examination at the time set without obtaining an approved postponement.

(c) The applicant, after two postponements, fails to appear for the examination at the appointed time.

Article 2.5. Applications for Registration Without Examination.

[No sections]

Article 3. Examinations

1640. Notification of Authorization to Take Examination.

Not less than thirty (30) days prior to the examination, each applicant qualified to take the exam shall be notified in writing of the date, time, and place of the examination.

REGISTRATION OF PROFESSIONAL FORESTERS RULES.

1640.1. Study Exams.

Copies of examination questions for the three (3) year period may be obtained upon payment of a fee covering direct cost of duplication as determined by the executive officer.

1640.2. Scheduling Examinations.

An application received less than sixty (60) days prior to an announced examination date may be scheduled for the next examination.

1640.3. Examinations Prescribed.

The examination shall test the applicant's understanding of the significant concept in and working knowledge of

- (1) Forest Economics,
- (2) Forest Protection,
- (3) Silviculture,
- (4) Forest Resources Management,
- (5) Forest Resources Use,
- (6) Dendrology,
- (7) Forest Ecology,
- (8) Forest Mensuration,
- (9) Forest Policy, and

(10) Forest Administration, as these apply to the management of forest lands to produce goods and services, and in terms of the environmental effects of such activities.

The committee shall prepare and administer an examination on the foregoing principles whenever the committee deems it necessary, but not less than twice per year. The special examination which may be administered on the basis of reciprocity to a person licensed in another state may be limited in scope to those subjects which in the opinion of the committee are unique to the practice of forestry in California .

1641. Examination Facilities.

The Executive Officer shall make all of the necessary arrangements to provide adequate facilities and assistants to conduct examinations in such locations as may be required to accommodate the number of applicants to be examined.

1642. Examination Irregularities.

Examinees are forbidden to receive unauthorized assistance during the examination. Communication between examinees or the use of unauthorized material or matter or devices during the examination is strictly prohibited. An applicant engaging in such conduct during the examination shall be notified that the examination shall not be graded, and shall be denied the opportunity to take the following two examinations.

1643. Successful Completion of Examination.

Following successful completion of the prescribed examination, the committee shall recommend to the Board approval for registration or certification of each qualified applicant.

1644. Denial of Application for Failure to Pass Examination.

If an applicant fails to obtain a passing grade in the prescribed examination, the committee shall deny the application without prejudice. The applicant shall be notified in writing of the right to appeal the examination following the procedures provided in Section 1647 of this article.

REGISTRATION OF PROFESSIONAL FORESTERS RULES.

1645. Inspection of Examination Papers.

An applicant who fails to receive a passing grade in the written examination may, within thirty (30) days of the examination results notice, request in writing:

- (a) A copy of the examination questions, and/or
- (b) Obtain a copy of his/her own answers which will be mailed after receipt of payment of a fee covering the direct cost of duplication as determined by the executive officer.
- (c) The applicant shall not be provided any answers of others, or the exam key. The Executive Officer shall not discuss any specific answers with the applicant because Expert Examiners mutually determine the answer scores.

1647. Appeal Procedure.

Within thirty (30) days of mailing or personal service notice, any real party of interest may appeal the actions of the Committee or Executive Officer to the Board for a review in accordance with PRC § 765 with respect to his or her qualifications in accordance with PRC § 769. The appeal for review shall be made in writing and shall include the reasons for or circumstances leading to the appeal, the items against which the appeal is made, supporting documentation, and shall be accompanied by a non-refundable fee of \$100. The Board's executive officer shall conduct a review thereon, and may, at his or her discretion, administer an oral or written examination or a re-grading of all or part of the examination as an aid in determining whether the applicant has satisfied the qualifications. Upon completion of the review, the Board's executive officer shall provide to the applicant in writing the final decision and reasons therefor. The decision of the Board's executive officer shall be final and binding.

Article 4. Miscellaneous.

1650. Specialties.

(a) As an alternative to being registered as a RPF, any person qualified pursuant to this Article is eligible for certification in a specialty. Both RPFs and non-RPFs are eligible for certification in a specialty. Only a person registered as a Certified Specialist may use this title of that specialty.

A certificate in each specialty created will be issued by the Board pursuant to the Section 772 of the Code. Specialties will be created by regulation as the need arises.

(b) The following certified specialties shall be implemented and overseen by the Executive Officer, with the assistance of the PFEC:

(1) Certified Rangeland Management Specialty

(c) To obtain Board recognition of its independent certification program, the professional society or public agency shall submit to the Board its program, including but not limited to any requirements for experience, education, disciplinary proceedings, and applicable testing. Upon a determination by the Board that the program fully protects the public interest by ensuring that individuals satisfying the requirements of the program possess the requisite experience and general knowledge in the area of practice encompassed by the program, the Board shall recognize the certification program as full qualification without examination for the Board's certificate of specialization, and the Board shall register as certified specialists those individuals who have met the requirements under the recognized program upon submission of such evidence to the Board.

(d) For independent certification programs submitted to the Board by a professional society or public agency pursuant to Section 772 of the Code, the following process and requirements shall apply:

(1) When a professional society or public agency establishes an internal certification panel for any or all of the following purposes: reviewing an applicant's qualifications, administering an examination to evaluate an applicant's professional understanding; reviewing allegations of misconduct; and administering discipline pursuant to the respective certification program; the panel members shall have first been certified by the Board as meeting the professional qualifications and standards for that certified specialty before undertaking their responsibilities pursuant to this section. The certification of the panel members may be done by a subcommittee of the PFEC appointed by

REGISTRATION OF PROFESSIONAL FORESTERS RULES.

the Board and composed of resource professionals in good standing representing a broad cross section of employment and expertise in that specialty. All subsequent panel members shall also be certified in this manner.

(2) The PFEC shall be notified by the professional society or public agency of any Certified Specialist who is guilty of violations of professional standards and issued discipline pursuant to the respective certification program. Subsequent to being granted the specialty certificate by the Board, the Certified Specialist shall be subject to disciplinary actions by the Board pursuant to Sections 775 through 778 of the Code, and any regulations promulgated thereunder. For disciplinary action pursuant to subsection (c) of Section 778 of the Code, the professional society or public agency establishing the independent certification program shall provide information related to demonstration of any fraud or deceit by an applicant in obtaining their registration or certification to the PFEC upon request by the PFEC. The professional society or public agency shall inform the PFEC of all complaints of violations or other misconduct relating to any Certified Specialist.

(3) The PFEC shall be notified of any proposed actions to be taken by a professional society or public agency which may affect the specialty certification program of the society or public agency, including but not limited to modification of the requirements for certification or professional accountability. Any modification to a specialty certification program must be approved by the PFEC prior to implementation. Modifications that significantly alter the qualifications and accountability within the recognized certification program must be approved by the Board.

(4) Prior to March 1 of each calendar year, those professional societies and public agencies with recognized independent certification programs shall submit to the Executive Officer of the PFEC a report which describes the previous calendar year accomplishments of the certification program, including but not limited to the number of applicants for certification, the approvals, denials, copies of examinations, and a summary of disciplinary actions, to insure the program fully protects the public interest. Failure to submit the report may result in the rescission of recognition of the certification program by the Board.

(e) Upon recognition by the Board of an independent certification program, the terms of the program shall be made publicly available by the professional society or public agency and posted on the Board's website.

(f) All Certified Specialists are subject to annual registration and fees for renewal of specialty certificates pursuant to 14 CCR, Sections 1605 and 1607. Additional fees may be required by the professional society or public agency responsible for the independent certification program.

(g) The Board may, from time to time, review an independent certification program which it has recognized pursuant to PRC § 772 to ensure the program fully protects the public interest through ensuring that individuals satisfying the requirements of the program possess the requisite experience and general knowledge in the area of practice encompassed by the program, and shall rescind its recognition of the independent certification program if it determines that the program does not fully protect such interest.

(h) In addition to rescission pursuant to subsection (g) of this Section, the Board may rescind its recognition of the independent certification program if it determines that the professional society or public agency fails to comply with any other requirements of this Section.

1651. Certified Rangeland Management Specialty.

(a) A "Certified Rangeland Manager (CRM)" is a person who provides services pursuant to Title 14 California Code of Regulations (CCR) 1602, at the request of the landowner or hiring agent, relating to the application of scientific principles to the art and science of managing rangelands and range on forested landscapes, as defined in California Public Resources Code § 754. A CRM shall perform professional services only in those subjects in which he or she is competent by training and experience.

REGISTRATION OF PROFESSIONAL FORESTERS RULES.

(b) When a CRM is providing range management services related to the production of forage and livestock on forested landscapes, an RPF shall be consulted if there are potential impacts on related forest resources.

(c) Qualifications as a CRM may be achieved by submitting to the Board evidence of certification by the professional society or public agency recognized under Public Resources Code § 772 as a Certified Rangeland Manager, subject to 14 CCR § 1650. The Board shall grant a specialty certificate upon (i) receiving evidence that the applicant has met the CRM qualifications under the terms of the program, has successfully completed any applicable written examination, has paid all fees due to the professional society or public agency, if any, and upon (ii) payment of all applicable fees to the Board pursuant to 14 CCR §§ 1605 and 1607.

SURFACE MINING AND RECLAMATION ACT/ REGULATIONS

SURFACE MINING AND RECLAMATION ACT OF 1975 Public Resources Code, Division 2, Chapter 9

[The Surface Mining and Reclamation Act of 1975 (SMARA) requires that a reclamation plan be approved for all sites where there is surface mining of minerals for commercial purposes and the removal of overburden in total amounts greater than 1,000 cubic yards in any one location. In 1996, changes were made to SMARA that allow for special provisions for excavation of grading of materials for roadbed construction and maintenance conducted in connection with Timber Operations of forest management on land owned by the same person or entity. These provisions are excerpted below. Complete provisions, PRC 2200 et seq. and 2700 et seq., may be found on the California Legislative Information website at <https://leginfo.ca.gov/>. Also included below are excerpts from the California Mining and Geology Board Reclamation Regulations. For complete provisions see the same online source as above, rather than the Public Resources Code, select the California Code of Regulations, sections 3500 et seq.]

Article 1. General Provisions

2710. Chapter Title.

This chapter shall be known and may be cited as the Surface Mining and Reclamation Act of 1975.

2711. Legislature Findings.

(a) The legislature hereby finds and declares that the extraction of minerals is essential to the continued economic well-being of the state and to the needs of the society, and that the reclamation of mined lands is necessary to prevent or minimize adverse effects on the environment and to protect the public health and safety.

(b) The Legislature hereby finds that the reclamation of mined lands as provided in this chapter will permit the continued mining of minerals and will provide for the protection and subsequent beneficial use of the mined and reclaimed land.

(c) The Legislature further finds that the surface mining takes place in diverse areas where the geologic, topographic, climatic, biological, and social conditions are significantly different and the reclamation operations and the specifications therefore may vary accordingly.

2712. Legislature Intent.

It is the intent of the Legislature to create and maintain an effective and comprehensive surface mining and reclamation policy with regulation of surface mining operation so as to assure that:

(a) Adverse environmental effects are prevented or minimized and that mined lands are reclaimed to a usable condition which is readily adaptable for alternative land uses.

(b) The production and conservation of minerals are encouraged, while giving consideration to values relating to recreation, watershed, wildlife, range and forage, and aesthetic enjoyment.

(c) Residual hazards to the public health and safety are eliminated.

2713. Private Property Rights.

It is not the intent of the Legislature by the enactment of this chapter to take private property for public use without payment of just compensation in violation of the California and United States Constitution.

2714. Exemptions.

This chapter does not apply to any of the following activities:

(j)(1) Excavations or grading for the exclusive purpose of obtaining materials for roadbed construction and maintenance conducted in connection with timber operation or forest management on land owned by the same person or entity. This exemption is limited to excavation and grading that is conducted adjacent to timber operation or forest management roads and shall not apply to onsite excavation or grading that occurs within 100 feet of a Class One Watercourse or 75 feet of a

SURFACE MINING AND RECLAMATION ACT/ REGULATIONS

Class Two Watercourse, or to excavation for materials that are, or have been, sold for commercial purposes.

(2) This exemption shall be available only if slope stability and erosion are controlled in accordance with subdivision (f) of Section 3704 and subdivision (d) of Section 3706 of Title 14 of the California Code of Regulations and, upon closure of the site, the person closing the site implements, where necessary, revegetation measures and post-closure uses in consultation with the Department of Forestry and Fire Protection.

STATE MINING AND GEOLOGY BOARD RECLAMATION REGULATIONS. California Code of Regulations, Title 14, Division 2, Chapter 8, Subchapter 1.

Article 9. Reclamation Standards.

3704. Performance Standards for Backfilling, Regrading, Slope Stability, and Recontouring.

Backfilling, regrading, slope stability, and recontouring shall conform with the following standards:

(f) Cut slopes, including final highwalls and quarry faces, shall have a minimum slope stability factor of safety that is suitable for the proposed end use and conform with the surrounding topography and/or approved end use.

3706(d). Performance Standards for Drainage, Diversion Structures, Waterways, and Erosion Control.

(d) Surface runoff and drainage from surface mining activities shall be controlled by berms, silt fences, sediment ponds, revegetation, hay bales, or other erosion control measures, to ensure that surrounding land and water resources are protected from erosion, gullyng, sedimentation and contamination. Erosion control methods shall be designed to handle runoff from not less than the 20 year/1 hour intensity storm event.

END

CALIFORNIA FOREST PRACTICE RULES 2024

Board of Forestry Technical Rule Addendum No. 1

CALIFORNIA STATE BOARD OF FORESTRY TECHNICAL RULE ADDENDUM NUMBER 1

Revised
February 1, 1990

Procedure for Estimating Surface Soil Erosion Hazard Rating

Note: The procedure noted in this addendum is to be used in application of rules 14 CCR 912.5, 932.5 and 952.5.

Introduction

The purpose of this addendum is to guide calculation of the surface soil erosion hazard rating.

Determination of the Surface Soil Erosion Hazard Rating

The proposed rating system form [form is attached to addendum] for use in making the Erosion Hazard Rating has been prepared in a manner to allow the RPF to make an assessment of each of the erosion factors. These factors which are significant determinants in erosion hazard include:

- (1) The inherent characteristics of the soil, including soil texture, depth to restrictive layer or bedrock, and percent of coarse surface fragments.
- (2) Slope of the land surface.
- (3) Protective vegetative cover.
- (4) Precipitation characteristics.

Each of the factors has been weighed in relation to: (1) the within-factor range; and (2) the relative importance between factors. These relative weights have been field tested, checked against various soil series of generally known erosion hazard, and compared to the accepted theoretical basis of the erosional process.

In order to complete the hazard rating form, the user shall estimate the level for each factor and sum the ratings. This sum is then used to determine the proper adjective. As an aid to the user in selecting the proper level for each factor, the discussions and descriptions have been provided in Appendix I.

APPENDIX I

I. Soil Factors: Soil factors are rated individually.

A. Soil Textures

1. Detachability

Detachability refers to the ease or difficulty with which soil materials are dispersed or detached by rain-drop impacts and/or overland flow water. Soil detachability and texture are closely related.

Soil texture refers to a range, percentage by weight, of soil fractional particle sizes of sand, silt, and clay which make up the natural soil material. Various specific size range percentages have been established for the existing soil textural classes. For example, sandy loams, loams, or clay textural classes.

(a) Field Determination of Soil Texture Class

Soil material used for textural determinations is that material which passes 2mm sieve. Field sample should be spread out in palm of hand and all coarse fragments over 2mm in size (approximately 1/10 of an inch) separated from the 2mm size material. Ocularly estimate percent of coarse fragment material. Also estimate total percent of surface occupied by stones, boulders, and rock fragments; add this percent to the total percentage of coarse fragments. Make soil textural determination on material estimated to pass the 2mm sieve.

The determination of soil class is made mainly by feeling the soil with the fingers, sometimes supplemented by examination under the hand lens. Moist soil feels different to the fingers than dry soil.

The following descriptions can be used when making such textural determinations by feel.

Sand: Sand is loose and single grained. The individual grains can readily be seen or felt. Squeezed in the hand when dry, it will fall apart when the pressure is released. Squeezed when moist, it will form a cast, but will crumble when touched.

Sandy Loam: A sandy loam is a soil containing much sand, but which has enough silt and clay to make it somewhat coherent. The individual sand grains can readily be seen and felt. Squeezed when dry, it will form a cast which will readily fall apart, but if squeezed when moist, a cast can be formed and will bear careful handling without breaking.

Loam: A loam is a soil having a relatively even mixture of different grades of sand and of silt and clay. It is fairly smooth and slightly plastic, with a somewhat gritty feel. Squeezed when dry, it will form a cast that will bear careful handling, while the cast formed by squeezing the moist soil can be handled quite freely without breaking.

Silt Loam: A silt loam is a soil having a moderate amount of fine grades of sand and only a small amount of clay, over half of the particles being of a size called "silt". When dry, it may appear cloddy, but the lumps can be readily broken, and when pulverized it feels soft and floury. When wet the soil readily puddles. Either dry or moist, it will form casts that can be freely handled without breaking, but when moistened and squeezed between thumb and finger, it will not "ribbon", but will give a broken appearance.

Clay Loam: A clay loam is a fine-textured soil which usually breaks into clods or lumps that are hard when dry. When the moist soil is pinched between the thumb and finger, it will form a thin "ribbon" which will break readily, barely sustaining its own weight. The moist soil is plastic and will form a cast that will bear much handling. When kneaded in the hand it does not crumble readily, but tends to work into a compact mass.

Clay: A clay is a fine-textured soil that usually forms very hard lumps or clods when dry and is quite plastic and usually sticky when wet. When the moist soil is pinched out between the thumb and fingers, it will form a long flexible "ribbon".

(b) Rating Factor Determination

As indicated previously, there is a strong correlation between soil texture and detachability. For example, the coarse sandy loams, etc. are, for the most part, single grained and normally easily detached. The fine clayey-textured soils on the other hand, are detached with difficulty. Using these relationships, rather than requiring an empirical field test for determining detachability, the following subjective Table 1 relating soil texture classes to detachability values is provided as part of the rating system. The common soil textural classes found in each of the broad texture groups have been assigned values. The user can select the detachability which best fit the surface soil textural class.

B. Depth to Restrictive Layer or Bedrock

This is related to the changes in soil permeability as well as to the depth of bedrock. For example, a soil profile having a sandy loam surface layer and a sandy clay subsoil would have restriction to water movement through the profile at the upper section of the sandy clay layer (Figure 1.).

Figure 1.

Examples of Various Soil Profile Configurations

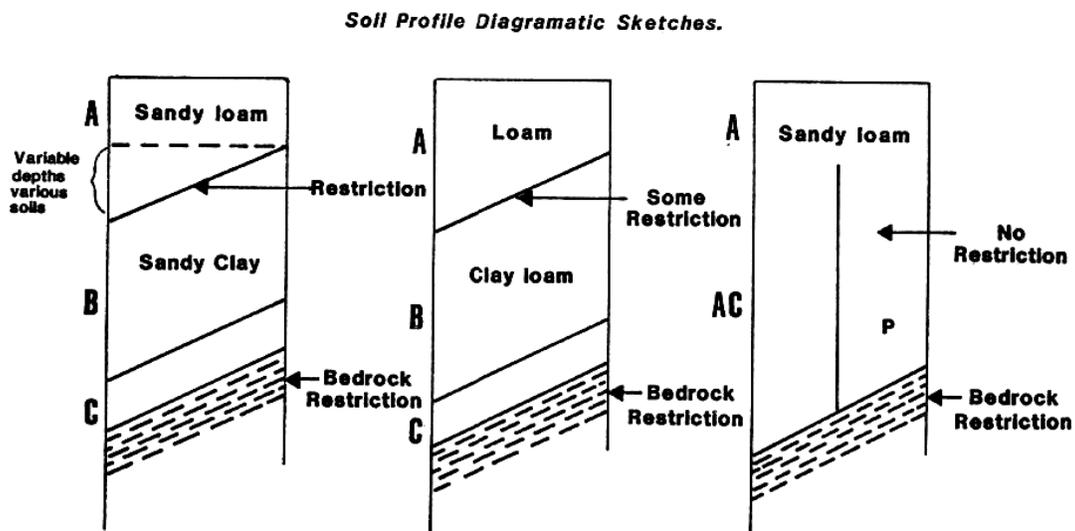

A soil profile having a loam-textured surface soil underlain by a clay loam or clay subsoil would also be restrictive to water movement at the upper section of the clay loam or clay subsoil.

Should there be no obvious soil textural difference between the surface of the soil to the underlying bedrock, then the depth to the bedrock would be the restrictive difference.

Existing soil survey maps and report information, as well as close examination of existing road cuts of the area in question or an actual excavated soil pit will reveal the information required.

C. Surface Coarse Fragments Including Rocks or Surface Stones

The degree of surface coarse fragments or surface rockiness or stoniness has a pronounced effect on surface erosion in reducing rain-drop impact as well as reducing the erosion potential of overland flow.

II. Slope Factor

Other than the inherent properties of soil, the slope factor is one of the most important of the erosion factors. The kinetic energy attributed to overland water is direct relation to velocity and volume. For the purpose of EHR determinations, general slope characteristics are considered in making slope measurements. For example, a generally smooth mountainside slope is measured by taking the predominant slope and length condition.

III. Vegetative Cover

- This refers to all organic material both living and dead which protects soils from rain-drop impact and/or overland flow, e.g., overstory vegetation, the understory of younger and smaller trees and shrubs, the ground cover of forbs, and grasses, and the litter, duff, slash and stumps. The vegetative factor is an estimate of the residual organic material likely to exist in the area immediately after timber operations. All roads, landings and skid trails are included as part of the disturbed area. Where a Timber Harvesting Plan includes a Site Preparation Addendum, the vegetative cover used in calculating the erosion hazard rating shall be based on the amount of vegetative cover reasonably expected to be present immediately following completion of site preparation activities.

IV. Rainfall

This refers to rainfall intensity based on a two-year return period. Attached is a rainfall intensity map of California. The information was taken from Technical Paper No. 28, U.S. Weather Bureau. This presented only as a guide. Should more localized information be available for a specific area, it should be used, especially to adjust for snowfall conditions.

TABLE 1

Soil Textural classes and Associated Suggested Ratings ^{1,2,3}

Broad Class	Texture	Rating
Coarse	Sands	30
	Loamy Sands	27
	Sandy Loams	23
	Fine Sandy Loams	20
Medium	Loams	17
	Silt Loams	14
	Silty Clay Loams	11
Fine	Clay Loams	8
	Clays	5
	Extremely Fine Clays	1

¹ The amount of organic matter incorporated with the soil mass has an effect on the ease or difficulty of soil particle detachment.

² Also, nonwetttable or difficult to wet soils will resist detachment. This phenomenon is lessened with continual wetting.

³ It is not unusual for soils to become nonwetttable within the surface layer following a wildfire or broadcast burning where spot areas have burns too hot.

2. Permeability

This is a measure of the rate at which water moves through soil. On a broad basis, soil textural classes can be used to estimate permeability and the associated factor.

TABLE 2

Soil Textures and Associated Permeabilities and Rating Factors

Soil Texture	Permeability	Factor
Sands)	Rapid	1
Loamy Sands)		
Sandy Loams)		
Fine Sandy Loams)		
Loams)	Moderate	2-3
Silt Loams)		
Silty Clay Loams)		
Clay Loams)	Slow	4-5
Clays)		
Extremely Fine Clays)		

ESTIMATED SURFACE SOIL EROSION HAZARD
 RM-87 (4/84)

STATE OF CALIFORNIA
 BOARD OF FORESTRY

SOIL FACTORS				FACTOR RATING BY AREA		
A. SOIL TEXTURE	Fine	Medium	Coarse	A	B	C
1. DETACHABILITY	Low	Moderate	High			
Rating	1-9	10-18	19-30			
2. PERMEABILITY	Slow	Moderate	Rapid			
Rating	5-4	3-2	1			

B. DEPTH TO RESTRICTIVE LAYER OR BEDROCK

	Shallow	Moderate	Deep			
	1"-19"	20"-39"	40"-60" (+)			
Rating	15-9	8-4	3-1			

C. PERCENT SURFACE COARSE FRAGMENTS GREATER THAN 2 MM IN SIZE INCLUDING ROCKS OR STONES

	Low	Moderate	High				FACTOR RATING BY AREA		
	(-) 10-39%	40-70%	71-100%				A	B	C
Rating	10-6	5-3	2-1						
SUBTOTAL									

II. SLOPE FACTOR

Slope	5-15%	16-30%	31-40%	41-50%	51-70%	71-80% (+)			
Rating	1-3	4-6	7-10	11-15	16-25	26-35			

III. PROTECTIVE VEGETATIVE COVER REMAINING AFTER DISTURBANCE

	Low	Moderate	High			
	0-40%	41-80%	81-100%			
Rating	15-8%	7-4	3-1			

IV. TWO-YEAR, ONE-HOUR RAINFALL INTENSITY (Hundredths Inch)

	Low	Moderate	High	Extreme				
	(-) 30-39	40-59	60-69	70-80 (+)				
Rating	1-3	4-7	8-11	12-15				
TOTAL SUM OF FACTORS								

EROSION HAZARD RATING

	<50	50-65	66-75	>75			
	LOW (L)	MODERATE (M)	HIGH (H)	EXTREME (E)			
THE DETERMINATION IS							

7540-130-0435

2-YEAR 1-HOUR RAINFALL

NORTHERN CALIFORNIA

